



**THE DATASHEET OF  
CP0603A1880MNTR**



# Thin-Film RF/Microwave Directional Couplers

## CP0302/CP0402/CP0603/CP0805 and DB0603N/DB0805 3dB 90°

### CP0603 High Directivity LGA Type



#### GENERAL DESCRIPTION

#### ITF (INTEGRATED THIN-FILM) TECHNOLOGY

The ITF LGA Coupler is based on thin-film multilayer technology. The technology provides a miniature part with excellent high frequency performance and rugged construction for reliable automatic assembly.

The ITF Coupler is offered in a variety of frequency bands compatible with various types of high frequency wireless systems.

#### APPLICATIONS

- 4G LTE
- 5G LTE
- Base Stations.
- Automotive
- Industrial
- Mobile Communications
- Satellite TV Receivers
- GPS
- Vehicle Location Systems
- Wireless LAN's

#### FEATURES

- Inherent Low Profile
- Self Alignment during Reflow
- Excellent Solderability
- Low Parasitics
- Better Heat Dissipation
- Operating/Storage Temp  
-40°C to +85°C
- Power Rating 5W RF Cont

#### DIMENSIONS: (Bottom View)

millimeters (inches)

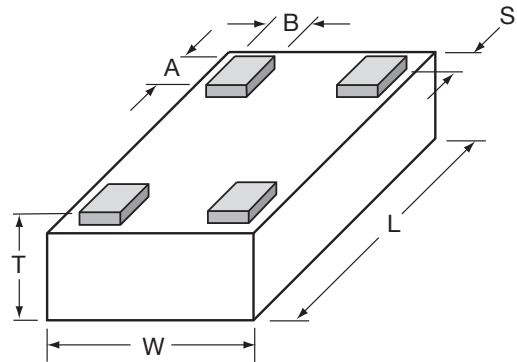

L	1.60±0.10 (0.063±0.004)
W	0.84±0.10 (0.033±0.004)
T	0.60±0.10 (0.024±0.004)

A	0.25±0.05 (0.010±0.002)
B	0.20±0.05 (0.008±0.002)
S	0.05±0.05 (0.002±0.002)

#### HOW TO ORDER

**CP**  
|  
**Style**  
Directional Coupler

**0603**  
|  
**Size**  
0603

**X**  
|  
**Type**

**\*\*\*\***  
|  
**Frequency**  
MHz

**X**  
|  
**Sub-Type**

**N**  
|  
**Termination Code**  
L = LGA Sn90, Pb10  
\*\*N= LGA Sn100

**TR**  
|  
**Packaging Code**  
TR = Tape and Reel

\*\*RoHS compliant

#### QUALITY INSPECTION

Finished parts are 100% tested for electrical parameters and visual characteristics. Each production lot is evaluated on a sample basis for:

- Static Humidity: 85°C, 85% RH, 160 hours
- Endurance: 125°C, I<sub>R</sub>, 4 hours

#### TERMINATION

Sn90Pb10 or Lead-Free Sn100 Nickel/Solder coating compatible with automatic soldering technologies: reflow, wave soldering, vapor phase and manual.

#### ORIENTATION IN TAPE

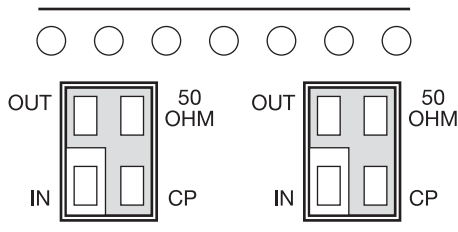

#### TERMINALS (TOP VIEW)

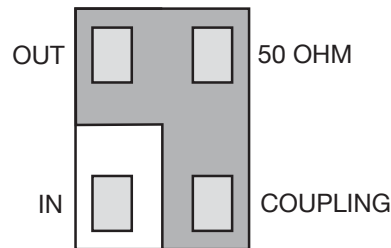

Not RoHS Compliant



LEAD-FREE  
LEAD-FREE COMPATIBLE  
COMPONENT



RoHS  
COMPLIANT

For RoHS compliant products,  
please select correct termination style.

#### Recommended Pad Layout Dimensions

mm (inches)

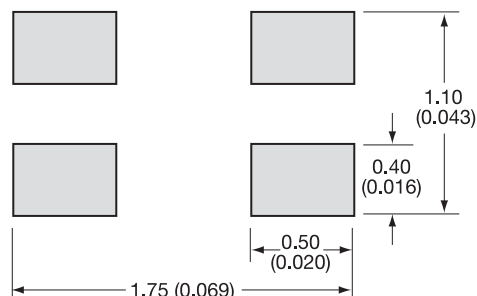

\*The recommended distance to the PCB Ground Plane is 0.254mm (0.010")



The Important Information/Disclaimer is incorporated in the catalog where these specifications came from or available online at [www.avx.com/disclaimer/](http://www.avx.com/disclaimer/) by reference and should be reviewed in full before placing any order.

**Thin-Film RF/Microwave Directional Couplers**  
**CP0302/CP0402/CP0603/CP0805 and DB0603N/DB0805 3dB 90°**  
**CP0603 High Directivity LGA Type**



**CP0603 - TYPE SELECTION CHART**

**Coupling vs. Frequency**

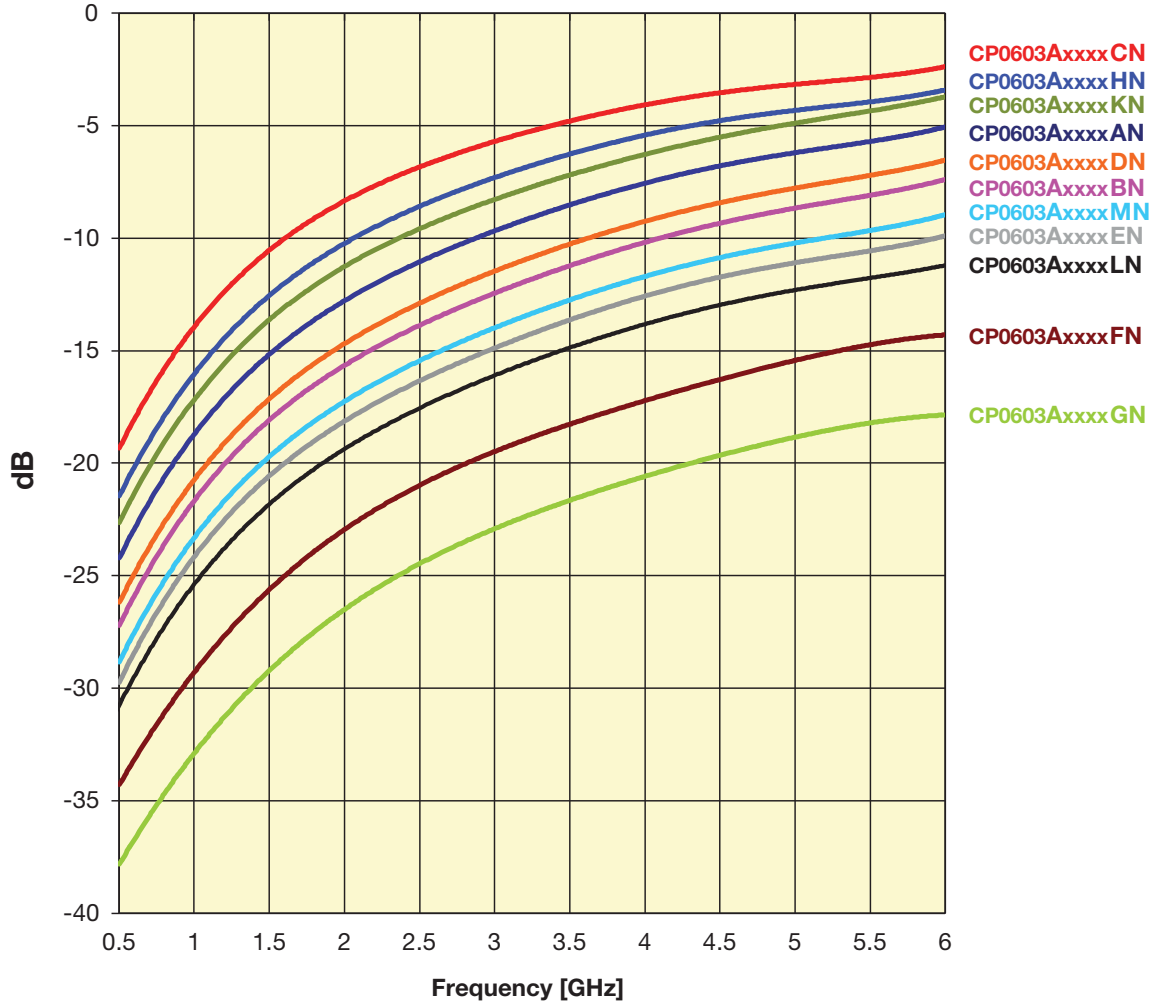

Intermediate coupling factors are readily available.  
 Please contact factory.

# Thin-Film RF/Microwave Directional Couplers

## CP0302/CP0402/CP0603/CP0805 and DB0603N/DB0805 3dB 90°

### CP0603 High Directivity LGA Type



Coupler P/N CP0603AxxxxAn

P/N Examples*	Frequency Band [MHz]	Coupling [dB]	I. Loss max. [dB]	Return Loss [dB]	Directivity [dB]
CP0603A0836AN	824 - 849	20.0	0.25	28	22
CP0603A0881AN	869 - 894	19.7	0.25	28	22
CP0603A0902AN	890 - 915	19.4	0.25	27	22
CP0603A0947AN	935 - 960	19.0	0.25	27	22
CP0603A0897AN	880 - 915	19.4	0.25	28	22
CP0603A0942AN	925 - 960	19.0	0.25	27	22
CP0603A1441AN	1429 - 1453	15.5	0.40	24	22
CP0603A1747AN	1710 - 1785	14.0	0.50	22	22
CP0603A1842AN	1805 - 1880	13.5	0.50	22	22
CP0603A1880AN	1850 - 1910	13.2	0.50	22	22
CP0603A1960AN	1930 - 1990	13.0	0.55	21	22
CP0603A1907AN	1895 - 1920	13.2	0.50	22	22
CP0603A1890AN	1880 - 1900	13.2	0.50	22	22
CP0603A2442AN	2400 - 2484	11.5	0.75	20	22
CP0603A3500AN	3450 - 3550	8.6	1.3	17	20
CP0603A5000AN	4950 - 5050	6.1	2.2	13	14
CP0603A5500AN	5450 - 5550	5.5	2.5	15	13
CP0603A6000AN	5950 - 6050	5	3	11.6	13

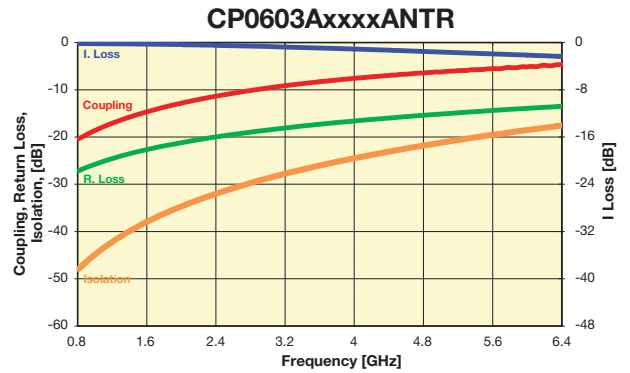

Coupler P/N CP0603AxxxxBN

P/N Examples*	Frequency Band [MHz]	Coupling [dB]	I. Loss max. [dB]	Return Loss [dB]	Directivity [dB]
CP0603A0836BN	824 - 849	23.0	0.20	31	24
CP0603A0881BN	869 - 894	22.7	0.20	31	24
CP0603A0902BN	890 - 915	22.5	0.20	31	24
CP0603A0947BN	935 - 960	22.0	0.20	30	24
CP0603A0897BN	880 - 915	22.5	0.20	31	24
CP0603A0942BN	925 - 960	22.0	0.20	30	24
CP0603A1441BN	1429 - 1453	18.5	0.25	27	24
CP0603A1747BN	1710 - 1785	17.0	0.25	25	21
CP0603A1842BN	1805 - 1880	16.4	0.25	25	21
CP0603A1880BN	1850 - 1910	16.2	0.25	25	21
CP0603A1960BN	1930 - 1990	16.0	0.25	24	21
CP0603A1907BN	1895 - 1920	16.1	0.25	25	21
CP0603A1890BN	1880 - 1900	16.2	0.25	25	21
CP0603A2442BN	2400 - 2484	14.2	0.35	23	21
CP0603A3500BN	3450 - 3550	11.2	0.6	20	20
CP0603A5000BN	4950 - 5050	8.4	1.1	16.7	17
CP0603A5500BN	5450 - 5550	7.8	1.4	15.7	16
CP0603A6000BN	5950 - 6050	7.2	1.6	15	15

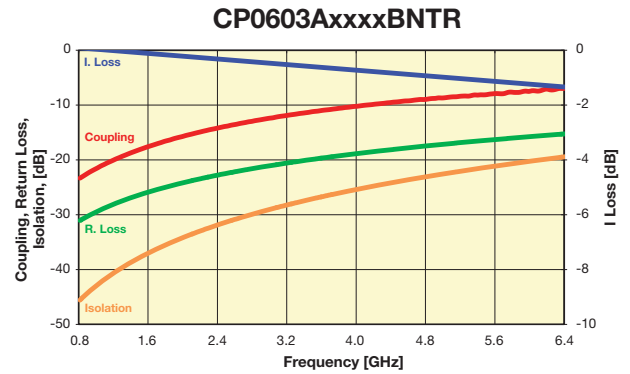

Coupler P/N CP0603AxxxxCN

P/N Examples*	Frequency Band [MHz]	Coupling [dB]	I. Loss max. [dB]	Return Loss [dB]	Directivity [dB]
CP0603A0836CN	824 - 849	15.2	0.35	23	23
CP0603A0881CN	869 - 894	15.0	0.35	23	23
CP0603A0902CN	890 - 915	14.7	0.35	23	23
CP0603A0947CN	935 - 960	14.3	0.40	22	23
CP0603A0897CN	880 - 915	14.7	0.35	23	23
CP0603A0942CN	925 - 960	14.3	0.40	22	23
CP0603A1441CN	1429 - 1453	11.0	0.70	19	23
CP0603A1747CN	1710 - 1785	9.5	0.80	18	21
CP0603A1842CN	1805 - 1880	9.0	0.90	17	21
CP0603A1880CN	1850 - 1910	8.8	0.90	17	21
CP0603A1960CN	1930 - 1990	8.5	1.00	17	21
CP0603A1907CN	1895 - 1920	8.8	0.90	17	21
CP0603A1890CN	1880 - 1900	8.8	0.90	17	21
CP0603A2442CN	2400 - 2484	7.0	1.40	15	21
CP0603A3500CN	3450 - 3550	4.8	2.0	23	20
CP0603A5000CN	4950 - 5050	3.0	3.6	21	17
CP0603A5500CN	5450 - 5550	3.0	4.0	20.6	16
CP0603A6000CN	5950 - 6050	2.5	4.5	20.5	16

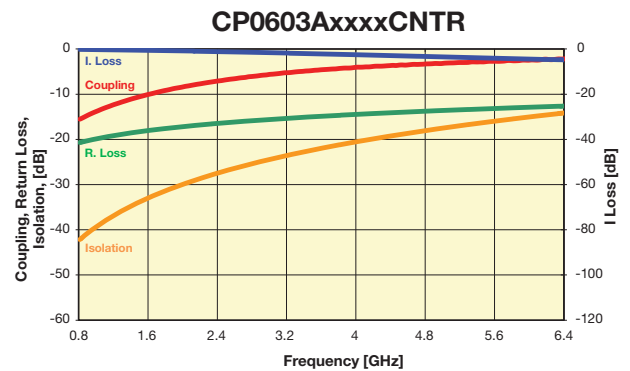

Important: Couplers can be used at any frequency within the indicated range.

# Thin-Film RF/Microwave Directional Couplers

## CP0302/CP0402/CP0603/CP0805 and DB0603N/DB0805 3dB 90°

### CP0603 High Directivity LGA Type



Coupler P/N CP0603AxxxxDN

P/N Examples*	Frequency Band [MHz]	Coupling [dB]	I. Loss max. [dB]	Return Loss [dB]	Directivity [dB]
CP0603A0836DN	824 - 849	22.0	0.25	31	30
CP0603A0881DN	869 - 894	21.8	0.25	30	30
CP0603A0902DN	890 - 915	21.3	0.25	30	30
CP0603A0947DN	935 - 960	21.0	0.30	30	30
CP0603A0897DN	880 - 915	21.3	0.25	30	30
CP0603A0942DN	925 - 960	21.0	0.30	30	30
CP0603A1441DN	1429 - 1453	17.7	0.40	27	30
CP0603A1747DN	1710 - 1785	16.0	0.40	25	25
CP0603A1842DN	1805 - 1880	15.4	0.40	25	25
CP0603A1880DN	1850 - 1910	15.2	0.40	24	25
CP0603A1960DN	1930 - 1990	15.0	0.40	24	25
CP0603A1907DN	1895 - 1920	15.2	0.40	24	25
CP0603A1890DN	1880 - 1900	15.2	0.40	24	25
CP0603A2442DN	2400 - 2484	13.3	0.55	22	25
CP0603A3500DN	3450 - 3550	10.1	0.66	25.3	20
CP0603A5000DN	4950 - 5050	7.8	1.17	21.1	18
CP0603A5500DN	5450 - 5550	6.8	1.39	19.9	18
CP0603A6000DN	5950 - 6050	6.3	1.64	18.8	17

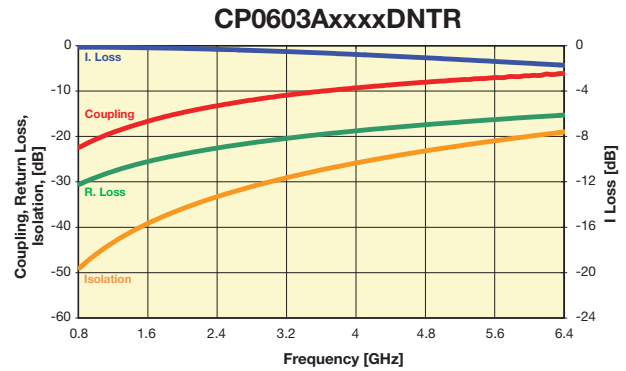

Coupler P/N CP603AxxxxEN

P/N Examples*	Frequency Band [MHz]	Coupling [dB]	I. Loss max. [dB]	Return Loss [dB]	Directivity [dB]
CP0603A0836EN	824 - 849	25.8	0.20	32	21
CP0603A0881EN	869 - 894	25.3	0.20	32	21
CP0603A0902EN	890 - 915	25.0	0.20	32	21
CP0603A0947EN	935 - 960	24.7	0.20	31	21
CP0603A0897EN	880 - 915	26.0	0.20	32	21
CP0603A0942EN	925 - 960	24.7	0.20	31	21
CP0603A1441EN	1429 - 1453	22.0	0.25	28	21
CP0603A1747EN	1710 - 1785	19.5	0.30	26	21
CP0603A1842EN	1805 - 1880	19.0	0.30	26	21
CP0603A1880EN	1850 - 1910	18.8	0.30	26	21
CP0603A1960EN	1930 - 1990	18.5	0.30	26	21
CP0603A1907EN	1895 - 1920	18.7	0.30	26	21
CP0603A1890EN	1880 - 1900	18.8	0.30	26	21
CP0603A2442EN	2400 - 2484	17.0	0.40	24	21
CP0603A3500EN	3450 - 3550	13.2	0.5	18	20
CP0603A5000EN	4950 - 5050	10.7	0.9	13	16
CP0603A5500EN	5450 - 5550	10.2	1.2	12	15
CP0603A6000EN	5950 - 6050	9.7	1.4	12	14

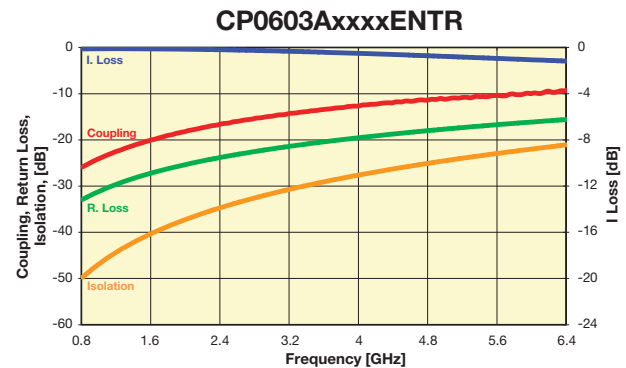

Coupler P/N CP603AxxxxFN

P/N Examples*	Frequency Band [MHz]	Coupling [dB]	I. Loss max. [dB]	Return Loss [dB]	Directivity [dB]
CP0603A0836FN	824 - 849	31.2	0.20	32	12
CP0603A0881FN	869 - 894	30.8	0.20	32	12
CP0603A0902FN	890 - 915	30.5	0.20	30	12
CP0603A0947FN	935 - 960	30.2	0.20	30	12
CP0603A0897FN	880 - 915	30.5	0.20	30	12
CP0603A0942FN	925 - 960	30.2	0.20	30	12
CP0603A1441FN	1429 - 1453	27.0	0.25	28	12
CP0603A1747FN	1710 - 1785	25.0	0.25	27	12
CP0603A1842FN	1805 - 1880	26.5	0.25	27	12
CP0603A1880FN	1850 - 1910	24.3	0.25	27	12
CP0603A1960FN	1930 - 1990	24.0	0.25	28	12
CP0603A1907FN	1895 - 1920	24.2	0.25	27	12
CP0603A1890FN	1880 - 1900	24.2	0.25	27	12
CP0603A2442FN	2400 - 2484	21.5	0.25	25	12
CP0603A3500FN	3450 - 3550	17.8	0.33	20.0	13
CP0603A5000FN	4950 - 5050	15.4	0.62	14.86	12
CP0603A5500FN	5450 - 5550	14.8	0.86	13.58	12
CP0603A6000FN	5950 - 6050	14.3	1.02	12.58	11

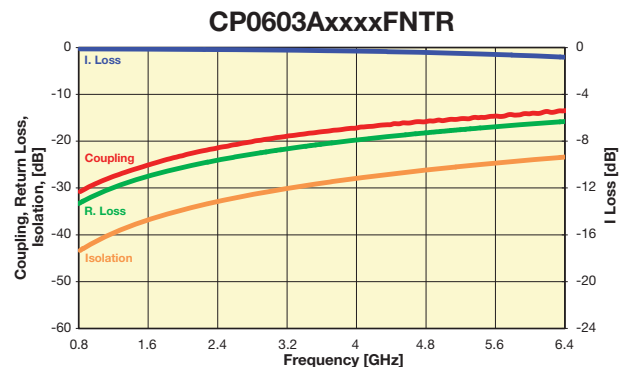

Important: Couplers can be used at any frequency within the indicated range.

# Thin-Film RF/Microwave Directional Couplers

## CP0302/CP0402/CP0603/CP0805 and DB0603N/DB0805 3dB 90°

### CP0603 High Directivity LGA Type



Coupler P/N CP603AxxxxGN

P/N Examples*	Frequency Band [MHz]	Coupling [dB]	I. Loss max. [dB]	Return Loss [dB]	Directivity [dB]
CP0603A0836GN	824 - 849	34.2	0.20	30	13
CP0603A0881GN	869 - 894	33.8	0.20	30	13
CP0603A0902GN	890 - 915	33.6	0.20	30	13
CP0603A0947GN	935 - 960	33.2	0.20	29	13
CP0603A0897GN	880 - 915	33.6	0.20	30	13
CP0603A0942GN	925 - 960	33.2	0.20	29	13
CP0603A1441GN	1429 - 1453	30.0	0.25	25	13
CP0603A1747GN	1710 - 1785	28.5	0.25	24	13
CP0603A1842GN	1805 - 1880	28.0	0.25	24	13
CP0603A1880GN	1850 - 1910	27.7	0.25	24	13
CP0603A1960GN	1930 - 1990	27.5	0.25	23	13
CP0603A1907GN	1895 - 1920	27.6	0.25	24	13
CP0603A1890GN	1880 - 1900	27.7	0.25	24	13
CP0603A2442GN	2400 - 2484	25.5	0.25	22	13
CP0603A3500GN	3450 - 3550	21.6	0.31	20	13
CP0603A5000GN	4950 - 5050	19	0.39	16	12
CP0603A5500GN	5450 - 5550	18.5	0.57	15	12
CP0603A6000GN	5950 - 6050	18.0	0.74	14	11

CP0603AxxxxGNTR

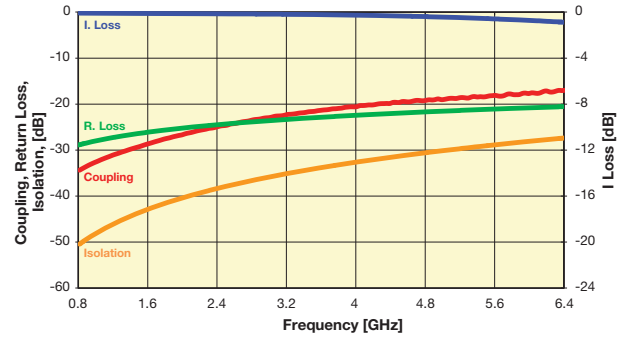

Coupler P/N CP603AxxxxHN

P/N Examples*	Frequency Band [MHz]	Coupling [dB]	I. Loss max. [dB]	Return Loss [dB]	Directivity [dB]
CP0603A0836HN	824 - 849	17.3	0.30	26	26
CP0603A0881HN	869 - 894	17.0	0.30	25	26
CP0603A0902HN	890 - 915	16.7	0.30	25	26
CP0603A0947HN	935 - 960	16.3	0.35	25	26
CP0603A0897HN	880 - 915	17.0	0.35	25	26
CP0603A0942HN	925 - 960	16.3	0.35	25	26
CP0603A1441HN	1429 - 1453	13.0	0.55	22	26
CP0603A1747HN	1710 - 1785	11.4	0.75	20	24
CP0603A1842HN	1805 - 1880	11.0	0.75	20	24
CP0603A1880HN	1850 - 1910	10.8	0.75	19	24
CP0603A1960HN	1930 - 1990	10.5	0.75	19	24
CP0603A1907HN	1895 - 1920	10.7	0.75	19	24
CP0603A1890HN	1880 - 1900	10.8	0.75	19	24
CP0603A2442HN	2400 - 2484	8.8	1.00	17	24
CP0603A3500HN	3450 - 3550	5.9	1.48	25	21
CP0603A5000HN	4950 - 5050	4.4	2.59	22	18
CP0603A5500HN	5450 - 5550	4	2.95	22	17
CP0603A6000HN	5950 - 6050	3.5	3.37	21	17

CP0603AxxxxHNTR

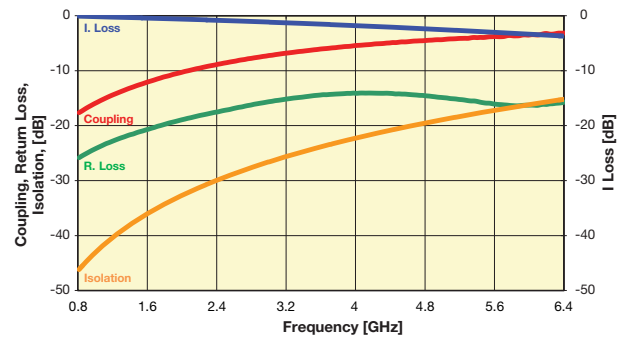

Coupler P/N CP603AxxxxMN

P/N Examples*	Frequency Band [MHz]	Coupling [dB]	I. Loss max. [dB]	Return Loss [dB]	Directivity [dB]
CP0603A0836MN	824 - 849	24.2	0.20	33	23
CP0603A0881MN	869 - 894	23.8	0.20	32	23
CP0603A0902MN	890 - 915	23.4	0.20	32	23
CP0603A0947MN	935 - 960	23.2	0.20	32	23
CP0603A0897MN	880 - 915	23.4	0.20	32	23
CP0603A0942MN	925 - 960	23.2	0.20	32	23
CP0603A1441MN	1429 - 1453	20.0	0.25	28	23
CP0603A1747MN	1710 - 1785	18.4	0.25	27	20
CP0603A1842MN	1805 - 1880	18.0	0.25	26	20
CP0603A1880MN	1850 - 1910	17.8	0.25	26	20
CP0603A1960MN	1930 - 1990	17.5	0.25	26	20
CP0603A1907MN	1895 - 1920	17.7	0.25	26	20
CP0603A1890MN	1880 - 1900	17.8	0.25	26	20
CP0603A2442MN	2400 - 2484	15.6	0.35	24	20
CP0603A3500MN	3450 - 3550	12.8	0.58	18	20
CP0603A5000MN	4950 - 5050	10.2	1.0	15	16
CP0603A5500MN	5450 - 5550	9.7	1.2	15	14
CP0603A6000MN	5950 - 6050	8.9	1.5	13.5	9

CP0603AxxxxMNTR

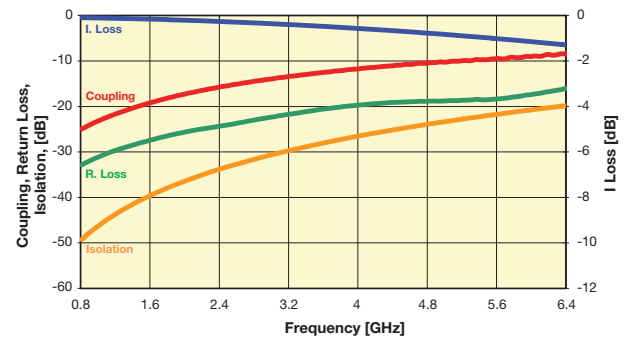

Important: Couplers can be used at any frequency within the indicated range.



The Important Information/Disclaimer is incorporated in the catalog where these specifications came from or available online at [www.avx.com/disclaimer/](http://www.avx.com/disclaimer/) by reference and should be reviewed in full before placing any order.

# Thin-Film RF/Microwave Directional Couplers

## CP0302/CP0402/CP0603/CP0805 and DB0603N/DB0805 3dB 90°

### CP0603 High Directivity LGA Type



Coupler P/N CP603AxxxxLN

P/N Examples*	Frequency Band [MHz]	Coupling [dB]	I. Loss max. [dB]	Return Loss [dB]	Directivity [dB]
CP0603A0836LN	824 - 849	26.89	0.08	32.5	18
CP0603A0881LN	869 - 894	26.55	0.08	32.2	18
CP0603A0902LN	890 - 915	26.2	0.09	31.9	18
CP0603A0947LN	935 - 960	25.87	0.09	31.5	18
CP0603A0897LN	880 - 915	26.2	0.09	31.9	18
CP0603A0942LN	925 - 960	25.87	0.09	31.5	18
CP0603A1441LN	1429 - 1453	22.31	0.12	28.1	17.5
CP0603A1747LN	1710 - 1785	20.51	0.15	26.4	16.5
CP0603A1842LN	1805 - 1880	20.03	0.15	26	16.5
CP0603A1880LN	1850 - 1910	19.87	0.16	26	16.5
CP0603A1890LN	1930 - 1990	19.57	0.17	25.5	16.5
CP0603A1907LN	1895 - 1920	19.77	0.16	25.7	16.5
CP0603A1890LN	1880 - 1900	19.87	0.16	25.8	16.5
CP0603A2442LN	2400 - 2484	17.7	0.22	23.9	16.5
CP0603A3500LN	3450 - 3550	14.85	0.56	20.6	16
CP0603A5000LN	4950 - 5050	12.4	0.95	17.8	11
CP0603A5500LN	5450 - 5550	11.83	1.2	17.1	9
CP0603A6000LN	5950 - 6050	11.08	1.33	15.9	9

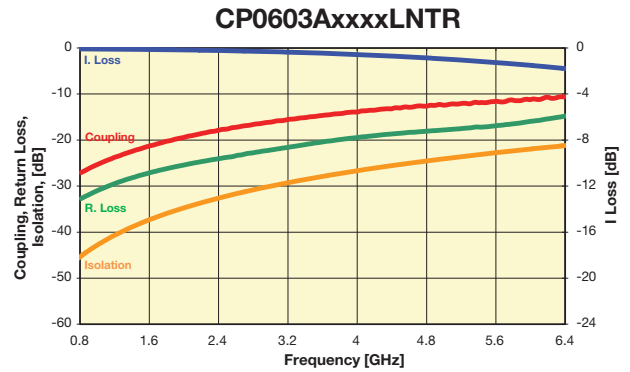

Coupler P/N CP603AxxxxKN

P/N Examples*	Frequency Band [MHz]	Coupling [dB]	I. Loss max. [dB]	Return Loss [dB]	Directivity [dB]
CP0603A0836KN	824 - 849	18.5	0.14	30	26
CP0603A0881KN	869 - 894	18.1	0.14	29	26
CP0603A0902KN	890 - 915	17.6	0.15	29	26
CP0603A0947KN	935 - 960	17.3	0.15	29	25
CP0603A0897KN	880 - 915	17.9	0.147	29	25
CP0603A0942KN	925 - 960	17.6	0.15	29	25
CP0603A1441KN	1429 - 1453	14	0.27	25	25
CP0603A1747KN	1710 - 1785	12.4	0.36	23	24
CP0603A1842KN	1805 - 1880	12	0.39	22.5	24
CP0603A1880KN	1850 - 1910	11.8	0.4	22	24
CP0603A1960KN	1930 - 1990	11.4	0.44	22	24
CP0603A1907KN	1895 - 1920	11.5	0.43	22	24
CP0603A1890KN	1880 - 1900	11.7	0.41	22	24
CP0603A2442KN	2400 - 2484	9.7	0.6	19	23
CP0603A3500KN	3450 - 3550	7.2	1.15	15	19
CP0603A5000KN	4950 - 5050	4.7	2.15	15	13
CP0603A5500KN	5450 - 5550	4.2	2.5	17	13
CP0603A6000KN	5950 - 6050	3.7	2.8	19	13

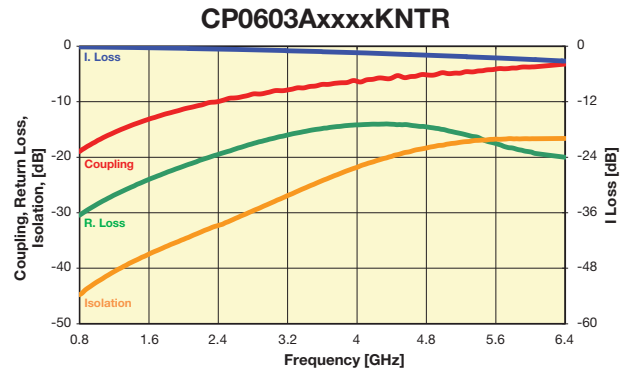

Important: Couplers can be used at any frequency within the indicated range.

# Thin-Film RF/Microwave Directional Couplers

## CP0302/CP0402/CP0603/CP0805 and DB0603N/DB0805 3dB 90°

### CP0402 / CP0603 High Directivity Couplers Test Jigs

#### GENERAL DESCRIPTION

These jigs are designed for testing the CP0402 and CP0603 High Directivity Couplers using a Vector Network Analyzer.

They consist of a dielectric substrate, having 50Ω microstrips as conducting lines and a bottom ground plane located at a distance of 0.254mm (0.010") from the microstrips.

The substrate used is Neltec's NH9338ST0254C1BC.

The connectors are SMA type (female), 'Johnson Components Inc.' Product P/N: 142-0701-841.

Both a measurement jig and a calibration jig are provided.

The calibration jig is designed for a full 2-port calibration, and consists of an open line, short line and through line. LOAD calibration can be done by a 50Ω SMA termination.

#### MEASUREMENT PROCEDURE

When measuring a component, it can be either soldered or pressed using a non-metallic stick until all four ports touch the appropriate pads. Set the VNA to the relevant frequency band. Connect the VNA using a 10dB attenuator on the jig terminal connected to port 2. Follow the VNA's instruction manual and use the [calibration jig](#) to perform a full 2-Port

calibration in the required bandwidths.

#### Place the coupler on the **measurement jig** as follows:

Input (Coupler)	↘	Connector 1 (Jig)	Termination (Coupler)	↘	Connector 3 (Jig)
Output (Coupler)	↘	Connector 2 (Jig)	Coupling (Coupler)	↘	Connector 4 (Jig)

#### To measure I. Loss connect:

Connector 1 (Jig)	↘	Port 1 (VNA)	Connector 3 (Jig)	↘	50Ω
Connector 2 (Jig)	↘	Port 2 (VNA)	Connector 4 (Jig)	↘	50Ω

#### To measure R. Loss and Coupling connect:

Connector 1 (Jig)	↘	Port 1 (VNA)	Connector 3 (Jig)	↘	50Ω
Connector 2 (Jig)	↘	50Ω	Connector 4 (Jig)	↘	Port 2 (VNA)

#### To measure Isolation connect:

Connector 1 (Jig)	↘	50Ω	Connector 3 (Jig)	↘	50Ω
Connector 2 (Jig)	↘	Port 1 (VNA)	Connector 4 (Jig)	↘	Port 2 (VNA)

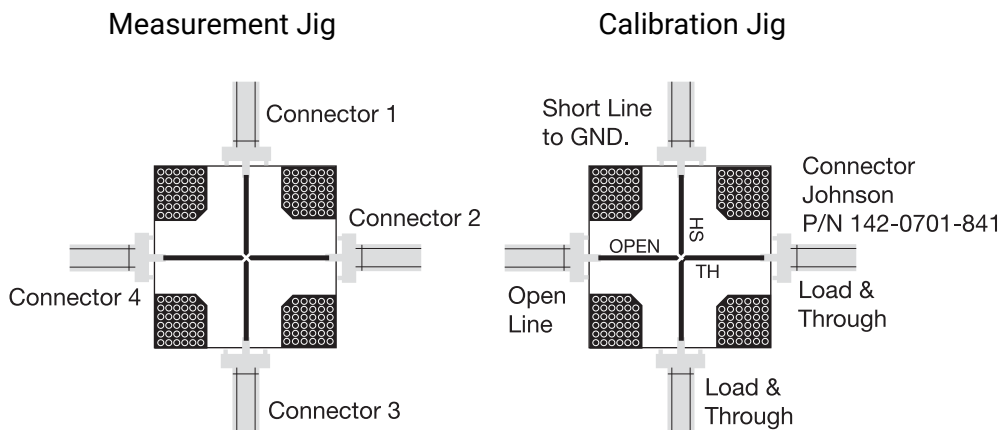

## Looking for pricing, stock, or lifecycle information?

Click below to explore more details on WIN SOURCE:

- ⊖ [View CP0603A1880MNTR on WIN SOURCE](#)
- ⊖ [AVX Corp/Kyocera Corp Information](#)

## Optimize Your Supply Chain with WIN SOURCE Solutions

- ✓ Global Sourcing Solution
- ✓ Obsolete Management
- ✓ Cost Control Management
- ✓ Shortage Management
- ✓ Alternative Solution
- ✓ Excess Inventory Management