



THE DATASHEET OF CEFA202-G



CEFA201-G Thru. CEFA203-G

Reverse Voltage: 50 to 200 Volts

Forward Current: 2.0 Amp

RoHS Device

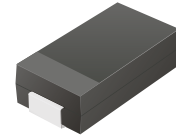

Features

- Ideal for surface mount applications.
- Easy pick and place.
- Plastic package has Underwriters Lab. flammability classification 94V-0.
- Super fast recovery time for high efficient.
- Built-in strain relief.
- Low forward voltage drop.

Mechanical data

- Case: JEDEC DO-214AC, molded plastic.
- Terminals: solderable per MIL-STD-750, method 2026.
- Polarity: Color band denotes cathode end.
- Approx. weight: 0.063 grams

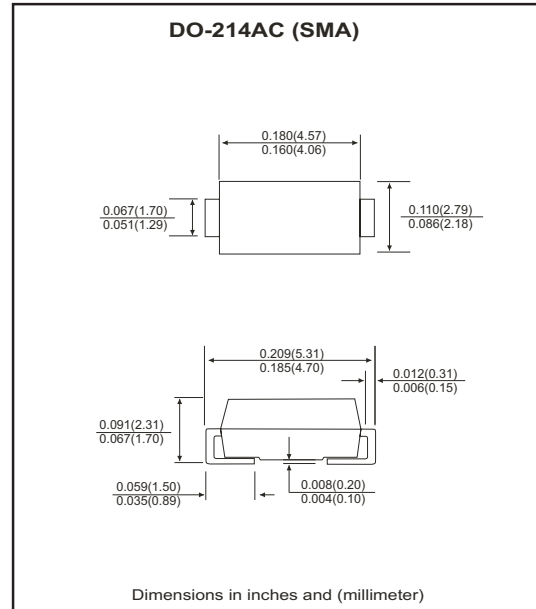

Maximum Ratings and Electrical Characteristics

Parameter	Symbol	CEFA201-G	CEFA202-G	CEFA203-G	Units
Max. repetitive peak reverse voltage	V_{RRM}	50	100	200	V
Max. DC blocking voltage	V_{DC}	50	100	200	V
Max. RMS voltage	V_{RMS}	35	70	140	V
Peak surge forward current, 8.3ms single half sine-wave superimposed on rate load (JEDEC method)	I_{FSM}	50			A
Max. average forward current	I_o	2.0			A
Max. instantaneous forward voltage at 2.0A	V_F	0.92			V
Reverse recovery time	T_{rr}	25			nS
Max. DC reverse current at $T_A=25^{\circ}C$ rated DC blocking voltage $T_A=100^{\circ}C$	I_R	5.0 100			μA
Max. thermal resistance (Note 1)	$R_{\theta JL}$	55			$^{\circ}C/W$
Max. operating junction temperature	T_J	150			$^{\circ}C$
Storage temperature	T_{STG}	-55 to +150			$^{\circ}C$

Notes: 1. Thermal resistance from junction to lead mounted on P.C.B. with 8.0×8.0 mm copper² pad area.

RATING AND CHARACTERISTIC CURVES (CEFA201-G thru CEFA203-G)

Fig.1 Reverse Characteristics

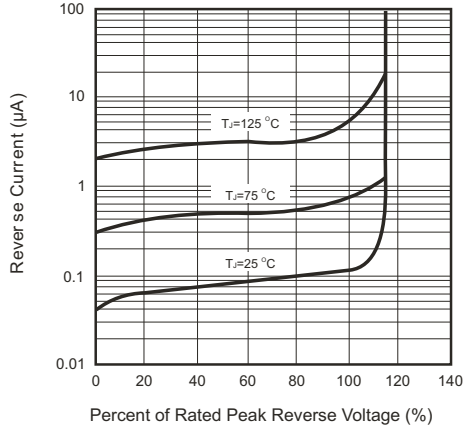

Fig.2 Forward Characteristics

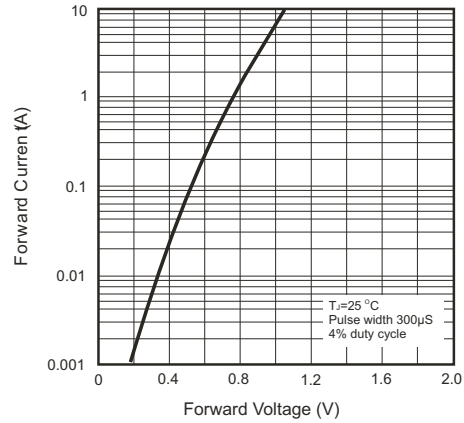

Fig.3 Current Derating Curve



Fig.4 Non-repetitive Forward Surge Current

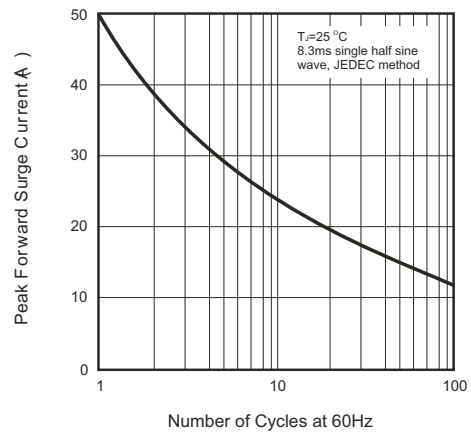
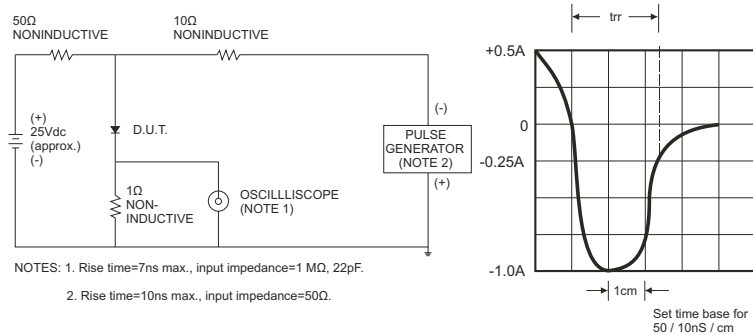



Fig.5 Test Circuit Diagram and Reverse Recovery Time Characteristics



Looking for pricing, stock, or lifecycle information?

Click below to explore more details on WIN SOURCE:

-  [View CEFA202-G on WIN SOURCE](#)
-  [Comchip Technology Information](#)

Optimize Your Supply Chain with WIN SOURCE Solutions

-  Global Sourcing Solution
-  Obsolete Management
-  Cost Control Management
-  Shortage Management
-  Alternative Solution
-  Excess Inventory Management