

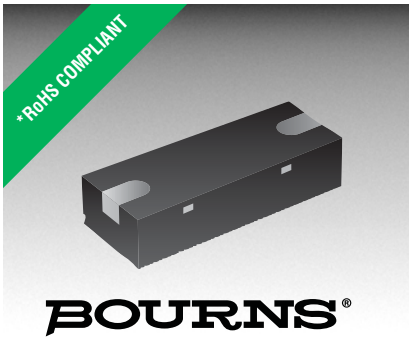

**THE DATASHEET OF
CDDFN2-T3.3LC**





Features

- Bidirectional TVS 3.3 V
- Low capacitance - 13 pF
- ESD protection >15 kV
- Fits 0402 footprint
- RoHS compliant*

Applications

- Computers and peripherals
- Communication systems
- Audio & video equipment
- Portable instrumentation

CDDFN2-T3.3LC - Surface Mount TVS Diode

General Information

The Bourns® Model CDDFN2-T3.3LC low capacitance device provides ESD, EFT and surge protection for external ports of electronic devices such as cellular phones, handheld electronics and other portable electronic devices.

The device measures 1.0 mm x 0.60 mm x 0.55 mm and is available in a DFN-2 package and is intended to be mounted directly onto an FR4 printed circuit board. The device will fit a 0402 footprint.

The device is designed to meet IEC 61000-4-2 (ESD), IEC 61000-4-4 (EFT) and IEC 61000-4-5 (Surge) protection requirements.

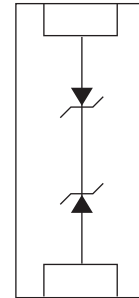

Thermal Characteristics (@ T_A = 25 °C Unless Otherwise Noted)

Parameter	Symbol	Min.	Typ.	Max.	Unit
Operating Supply Voltage	V _{DC}	-3.8		3.8	V
Peak Pulse Current @ 8/20 μs	I _{PP}		5		A
Operating Temperature	T _{OPR}	-55	+25	+125	°C
Storage Temperature	T _{STG}	-55	+25	+150	°C

Electrical Characteristics (@ T_A = 25 °C Unless Otherwise Noted)

Parameter	Symbol	Min.	Typ.	Max.	Unit
Working Peak Voltage	V _{WM}		3.0	3.3	V
Breakdown Voltage @ 1 mA	V _{BR}	4		6.5	V
Leakage Current @ 3.3 V	I _L		0.1	1.0	μA
Capacitance @ 0 V, 1 MHz	C _J		13	16.5	pF
Clamping Voltage @ I _P = 1 A 8/20 μs	V _C		5.0	6.5	V
Clamping Voltage @ I _{PP} = 5 A 8/20 μs	V _C		6.5	8	V
ESD Protection per IEC 61000-4-2					
Contact Discharge	ESD	8			kV
Air Discharge	ESD	15			kV
EFT Protection per IEC 61000-4-4 @ 5/50 nS	EFT			50	A
EFT Protection per IEC 61000-4-5 @ 8/20 μS	Surge			5	A

BOURNS®

Asia-Pacific: Tel: +886-2 2562-4117 • Fax: +886-2 2562-4116

Europe: Tel: +41-41 768 5555 • Fax: +41-41 768 5510

The Americas: Tel: +1-951 781-5500 • Fax: +1-951 781-5700

www.bourns.com

*RoHS Directive 2002/95/EC Jan. 27, 2003 including annex and RoHS Recast 2011/65/EU June 8, 2011. Specifications are subject to change without notice.

Customers should verify actual device performance in their specific applications.

CDDFN2-T3.3LC - Surface Mount TVS Diode



Product Dimensions

This is a molded DFN-2 package with lead free 100 % Sn plating on the terminations. It weighs approximately 30 mg.

TOP VIEW

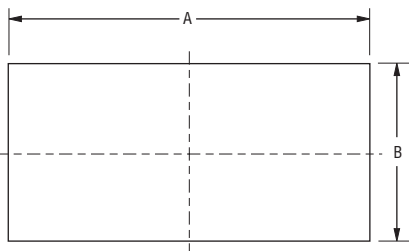

SIDE VIEW

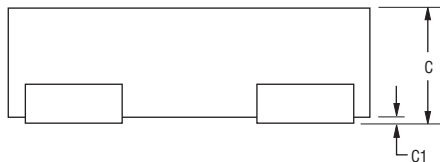

BOTTOM VIEW

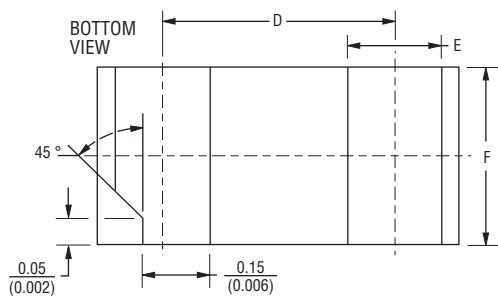

DIMENSIONS: $\frac{\text{MM}}{\text{(INCHES)}}$

Symbol	Dimensions		
	Min.	Nom.	Max.
A		$\frac{1.00}{(0.039)}$	
B		$\frac{0.60}{(0.024)}$	
C	$\frac{0.51}{(0.020)}$	$\frac{0.55}{(0.022)}$	$\frac{0.60}{(0.024)}$
C1	$\frac{0.00}{(0.000)}$	$\frac{0.02}{(0.001)}$	$\frac{0.05}{(0.002)}$
D		$\frac{0.65}{(0.026)}$	
E	$\frac{0.10}{(0.004)}$	$\frac{0.25}{(0.010)}$	$\frac{0.35}{(0.014)}$
F	$\frac{0.45}{(0.018)}$	$\frac{0.60}{(0.024)}$	$\frac{0.70}{(0.028)}$

DIMENSIONS: $\frac{\text{MM}}{\text{(INCHES)}}$

Recommended PCB Footprint

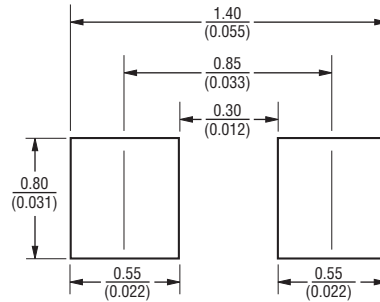

Typical Part Marking

CDDFN2-T3.3LC3L

How to Order

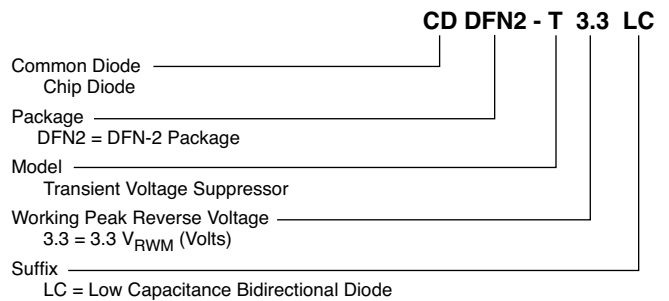

Block Diagram

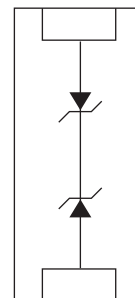

Specifications are subject to change without notice. Customers should verify actual device performance in their specific applications.

CDDFN2-T3.3LC - Surface Mount TVS Diode



Performance Graphs

Pulse Waveform

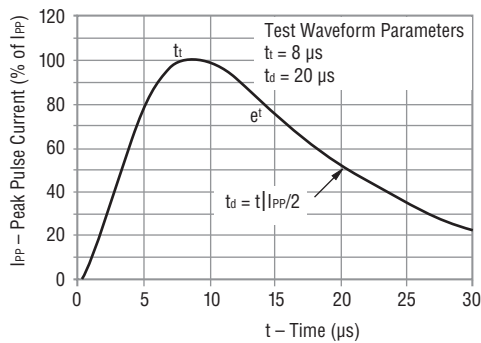

Overshoot & Clamping Voltage

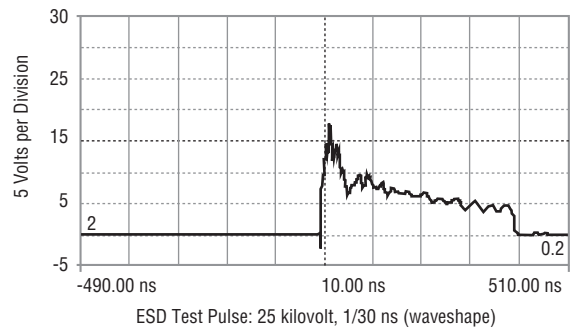

Typical Capacitance Variation of C_{IN} vs V_{IN}

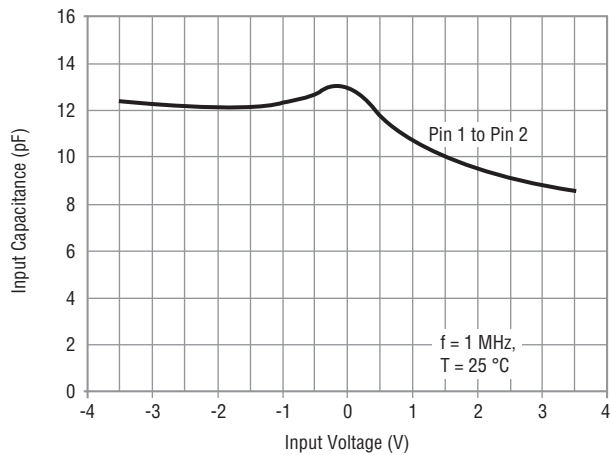

Power Derating Curve

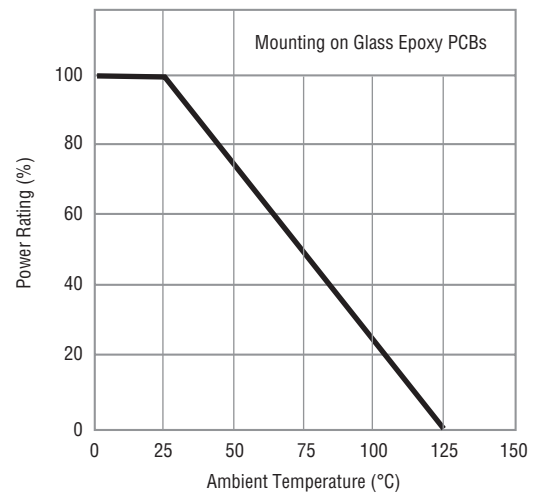

CDDFN2-T3.3LC - Surface Mount TVS Diode

BOURNS®

Packaging Information

The surface mount product is packaged in an 8 mm x 4 mm tape and reel format per EIA-481 standard.

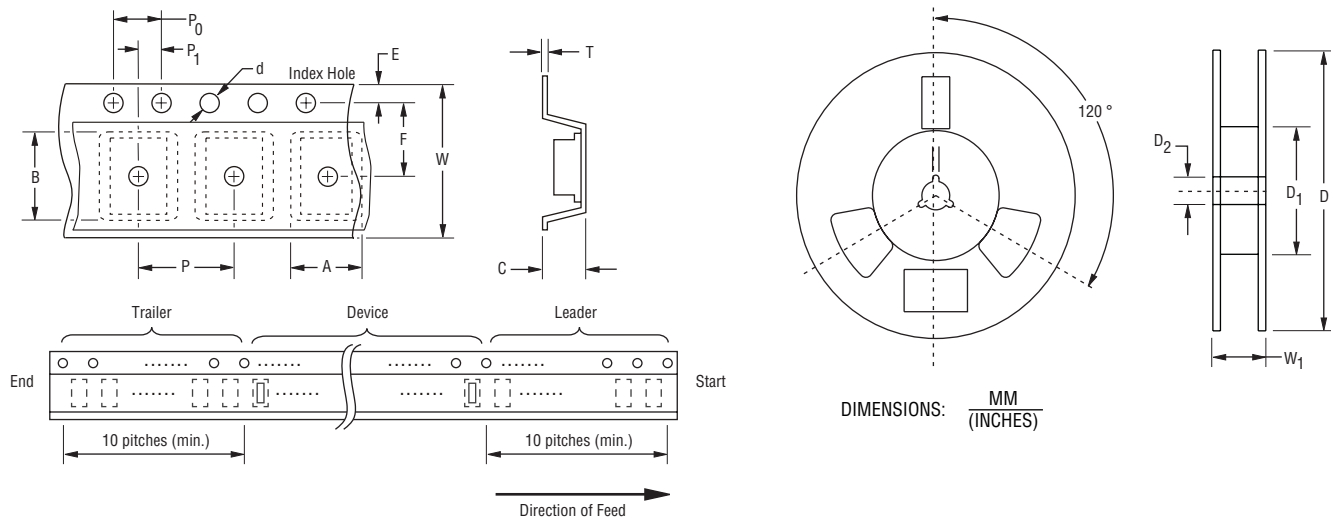

Item	Symbol	DFN-2
Carrier Width	A	$\frac{0.80 \pm 0.10}{(0.031 \pm 0.004)}$
Carrier Length	B	$\frac{1.20 \pm 0.10}{(0.047 \pm 0.004)}$
Carrier Depth	C	$\frac{0.70 \pm 0.10}{(0.027 \pm 0.004)}$
Sprocket Hole	d	$\frac{1.55 \pm 0.05}{(0.061 \pm 0.002)}$
Reel Outside Diameter	D	$\frac{178}{(7.008)}$
Reel Inner Diameter	D ₁	$\frac{50.0}{(1.969)}$ MIN.
Feed Hole Diameter	D ₂	$\frac{13.0 \pm 0.20}{(0.512 \pm 0.008)}$
Sprocket Hole Position	E	$\frac{1.75 \pm 0.10}{(0.069 \pm 0.004)}$
Punch Hole Position	F	$\frac{3.50 \pm 0.05}{(0.138 \pm 0.002)}$
Punch Hole Pitch	P	$\frac{4.00 \pm 0.10}{(0.157 \pm 0.004)}$
Sprocket Hole Pitch	P ₀	$\frac{4.00 \pm 0.10}{(0.157 \pm 0.004)}$
Embossment Center	P ₁	$\frac{2.00 \pm 0.05}{(0.079 \pm 0.002)}$
Overall Tape Thickness	T	$\frac{0.20 \pm 0.10}{(0.008 \pm 0.004)}$
Tape Width	W	$\frac{8.00 \pm 0.20}{(0.315 \pm 0.008)}$
Reel Width	W ₁	$\frac{14.4}{(0.567)}$ MAX.
Quantity per Reel	--	5000

REV. 02/12

Specifications are subject to change without notice.
Customers should verify actual device performance in their specific applications.

Looking for pricing, stock, or lifecycle information?

Click below to explore more details on WIN SOURCE:

- ⊖ [View CDDFN2-T3.3LC on WIN SOURCE](#)
- ⊖ [Bourns Inc. Information](#)

Optimize Your Supply Chain with WIN SOURCE Solutions

- ✓ Global Sourcing Solution
- ✓ Obsolete Management
- ✓ Cost Control Management
- ✓ Shortage Management
- ✓ Alternative Solution
- ✓ Excess Inventory Management