



**THE DATASHEET OF
BZX84C3V0W**



ZENER DIODE

FEATURES

- Planar Die Construction
- 200mW Power Dissipation
- Zener Voltages from 2.4V - 39V
- Ultra-Small Surface Mount Package Power Dissipation

SOT-323

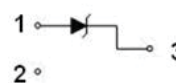
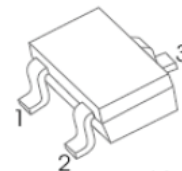

Maximum Ratings(T_a=25°C unless otherwise specified)

Characteristic	Symbol	Value	Unit
Forward Voltage (Note 2) @ I _F = 10mA	V _F	0.9	V
Power Dissipation(Note 1)	P _D	200	mW
Thermal Resistance from Junction to Ambient	R _{θJA}	625	°C/W
Junction Temperature	T _j	-55~+150	°C
Storage Temperature Range	T _{stg}	-55~+150	°C

ELECTRICAL CHARACTERISTICS $T_a=25^\circ\text{C}$ unless otherwise specified

Type Number	Marking Code	Zener Voltage Range (Note 2)				Maximum Zener Impedance (Note 3)			Maximum Reverse Current		Temperature Coefficient of Zener Voltage @ $I_{ZT} = 5\text{mA}$ ($\text{mV}/^\circ\text{C}$)	
		$V_Z @ I_{ZT}$			I_{ZT}	$Z_{ZT} @ I_{ZT}$	$Z_{ZK} @ I_{ZK}$	I_{ZK}	I_R	@ V_R	Min	Max
		Nom (V)	Min (V)	Max (V)	mA	Ω	mA	μA	V			
BZX84C2V4W	KRB	2.4	2.2	2.6	5.0	100	600	1.0	50	1.0	-3.5	0
BZX84C2V7W	KRC	2.7	2.5	2.9	5.0	100	600	1.0	20	1.0	-3.5	0
BZX84C3V0W	KRD	3.0	2.8	3.2	5.0	95	600	1.0	20	1.0	-3.5	0
BZX84C3V3W	KRE	3.3	3.1	3.5	5.0	95	600	1.0	5.0	1.0	-3.5	0
BZX84C3V6W	KRF	3.6	3.4	3.8	5.0	90	600	1.0	5.0	1.0	-3.5	0
BZX84C3V9W	KRG	3.9	3.7	4.1	5.0	90	600	1.0	3.0	1.0	-3.5	0
BZX84C4V3W	KRH	4.3	4.0	4.6	5.0	90	600	1.0	3.0	1.0	-3.5	0
BZX84C4V7W	KR1	4.7	4.4	5.0	5.0	80	600	1.0	3.0	2.0	-3.5	0.2
BZX84C5V1W	KR2	5.1	4.8	5.4	5.0	60	500	1.0	2.0	2.0	-2.7	1.2
BZX84C5V6W	KR3	5.6	5.2	6.0	5.0	40	480	1.0	1.0	2.0	-2.0	2.5
BZX84C6V2W	KR4	6.2	5.8	6.6	5.0	10	400	1.0	3.0	4.0	0.4	3.7
BZX84C6V8W	KR5	6.8	6.4	7.2	5.0	15	150	1.0	2.0	4.0	1.2	4.5
BZX84C7V5W	KR6	7.5	7.0	7.9	5.0	15	80	1.0	1.0	5.0	2.5	5.3
BZX84C8V2W	KR7	8.2	7.7	8.7	5.0	15	80	1.0	0.7	5.0	3.2	6.2
BZX84C9V1W	KR8	9.1	8.5	9.6	5.0	15	80	1.0	0.5	6.0	3.8	7.0
BZX84C10W	KR9	10	9.4	10.6	5.0	20	100	1.0	0.2	7.0	4.5	8.0
BZX84C11W	KP1	11	10.4	11.6	5.0	20	150	1.0	0.1	8.0	5.4	9.0
BZX84C12W	KP2	12	11.4	12.7	5.0	25	150	1.0	0.1	8.0	6.0	10.0
BZX84C13W	KP3	13	12.4	14.1	5.0	30	150	1.0	0.1	8.0	7.0	11.0
BZX84C15W	KP4	15	13.8	15.6	5.0	30	170	1.0	0.1	10.5	9.2	13.0
BZX84C16W	KP5	16	15.3	17.1	5.0	40	200	1.0	0.1	11.2	10.4	14.0
BZX84C18W	KP6	18	16.8	19.1	5.0	45	200	1.0	0.1	12.6	12.4	16.0
BZX84C20W	KP7	20	18.8	21.2	5.0	55	225	1.0	0.1	14.0	14.4	18.0
BZX84C22W	KP8	22	20.8	23.3	5.0	55	225	1.0	0.1	15.4	16.4	20.0
BZX84C24W	KP9	24	22.8	25.6	5.0	70	250	1.0	0.1	16.8	18.4	22.0
BZX84C27W	KPA	27	25.1	28.9	2.0	80	250	0.5	0.1	18.9	21.4	25.3
BZX84C30W	KPB	30.0	28.0	32.0	2.0	80	300	0.5	0.1	21.0	24.4	29.4
BZX84C33W	KPC	33.0	31.0	35.0	2.0	80	300	0.5	0.1	23.1	27.4	33.4
BZX84C36W	KPD	36.0	34.0	38.0	2.0	90	325	0.5	0.1	25.2	30.4	37.4
BZX84C39W	KPE	39.0	37.0	41.0	2.0	130	350	0.5	0.1	27.3	33.4	41.2

- Notes: 1. Valid provided that device terminals are kept at ambient temperature.
 2. Tested with pulses, 300 μs pulse width, 2% duty cycle.
 3. $f = 1\text{kHz}$.

RATING AND CHARACTERISTICS CURVES (BZX84C2V4W THRU BZX84C39W)

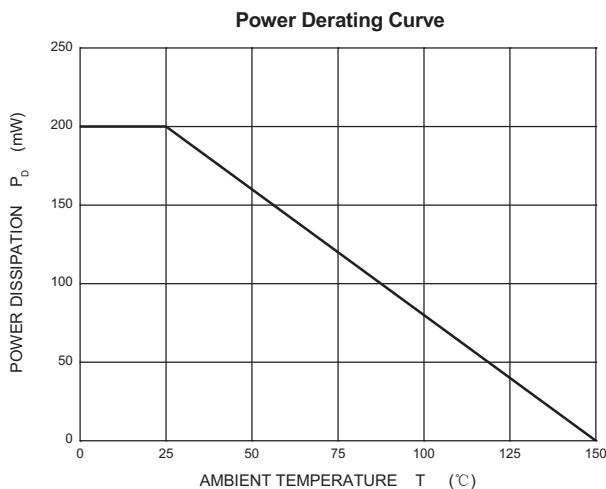
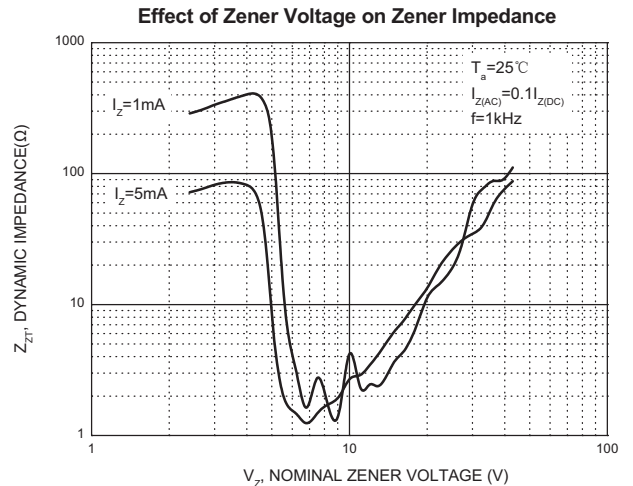
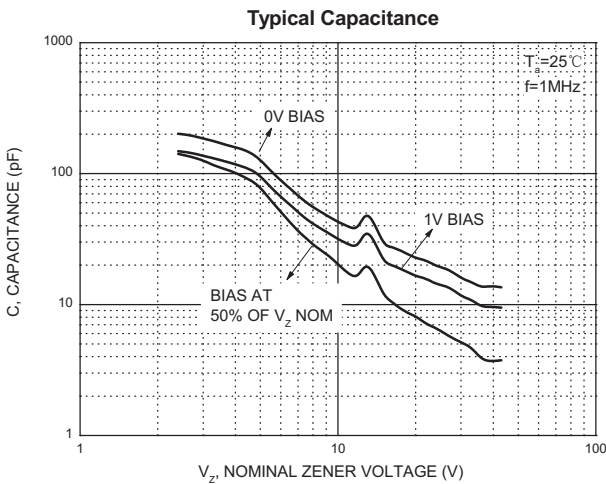
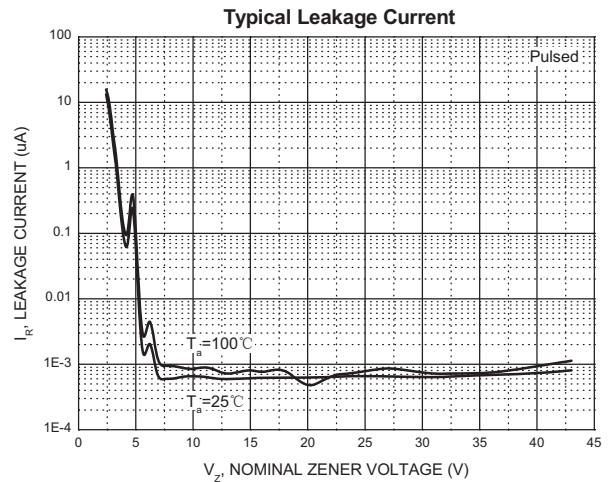
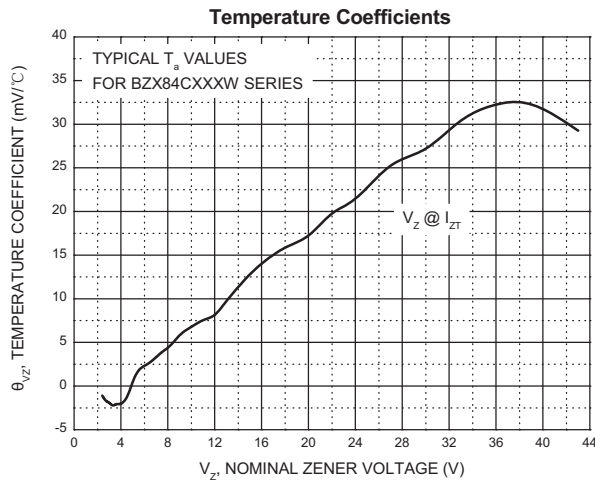
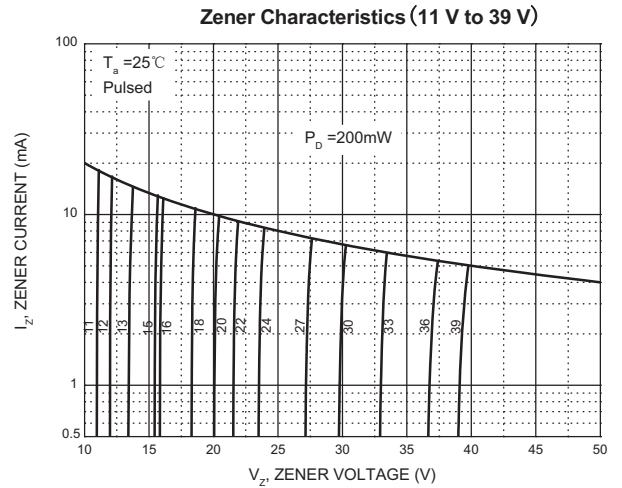
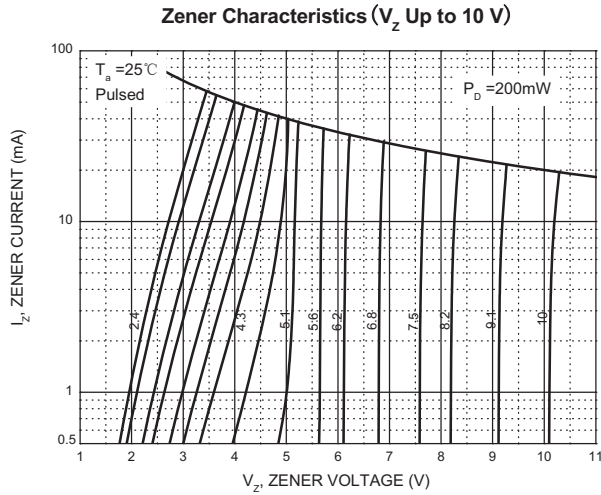

SOT-323 Package Outline Dimensions

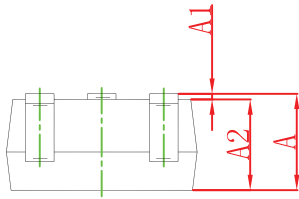
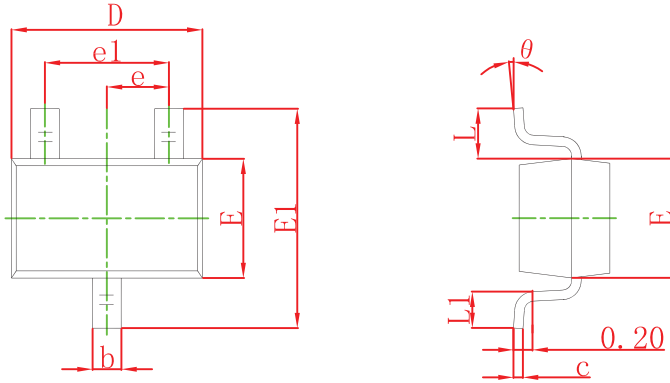

Symbol	Dimensions In Millimeters		Dimensions In Inches	
	Min	Max	Min	Max
A	0.900	1.100	0.035	0.043
A1	0.000	0.100	0.000	0.004
A2	0.900	1.000	0.035	0.039
b	0.200	0.400	0.008	0.016
c	0.080	0.150	0.003	0.006
D	2.000	2.200	0.079	0.087
E	1.150	1.350	0.045	0.053
E1	2.150	2.450	0.085	0.096
e	0.650 TYP		0.026 TYP	
e1	1.200	1.400	0.047	0.055
L	0.525 REF		0.021 REF	
L1	0.260	0.460	0.010	0.018
theta	0°	8°	0°	8°

SOT-323 Suggested Pad Layout

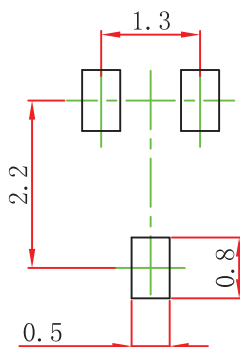

- Note:
1. Controlling dimension: in millimeters.
 2. General tolerance: ± 0.05 mm.
 3. The pad layout is for reference purposes only.

SOT-323 Tape and Reel

SOT-323 Embossed Carrier Tape

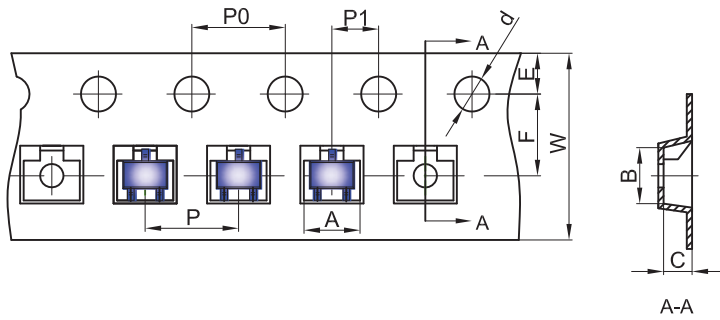

Packaging Description:
 SOT-323 parts are shipped in tape. The carrier tape is made from a dissipative (carbon filled) polycarbonate resin. The cover tape is a multilayer film (Heat Activated Adhesive in nature) primarily composed of polyester film, adhesive layer, sealant, and anti-static sprayed agent. These reeled parts in standard option are shipped with 3,000 units per 7" or 17.8cm diameter reel. The reels are clear in color and is made of polystyrene plastic (anti-static coated).

Dimensions are in millimeter										
Pkg type	A	B	C	d	E	F	P0	P	P1	W
SOT-323	2.25	2.55	1.19	Ø1.55	1.75	3.50	4.00	4.00	2.00	8.00

SOT-323 Tape Leader and Trailer

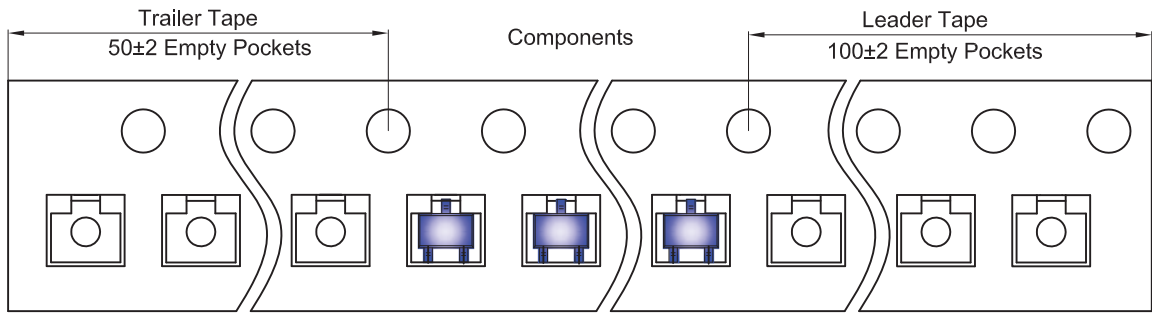

SOT-323 Reel

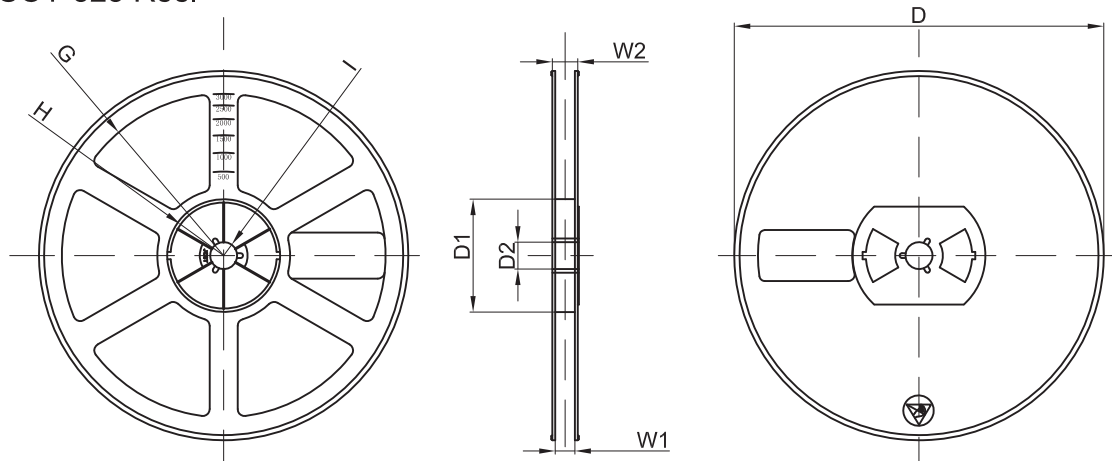

Dimensions are in millimeter								
Reel Option	D	D1	D2	G	H	I	W1	W2
7" Dia	Ø178.00	54.40	13.00	R78.00	R25.60	R6.50	9.50	12.30

REEL	Reel Size	Box	Box Size(mm)	Carton	Carton Size(mm)	G.W.(kg)
3000 pcs	7 inch	45,000 pcs	203×203×195	180,000 pcs	438×438×220	



DISCLAIMER NOTICE

Rectron Inc reserves the right to make changes without notice to any product specification herein, to make corrections, modifications, enhancements or other changes. Rectron Inc or anyone on its behalf assumes no responsibility or liability for any errors or inaccuracies. Data sheet specifications and its information contained are intended to provide a product description only. "Typical" parameters which may be included on RECTRON data sheets and/ or specifications can and do vary in different applications and actual performance may vary over time. Rectron Inc does not assume any liability arising out of the application or use of any product or circuit.

Rectron products are not designed, intended or authorized for use in medical, life-saving implant or other applications intended for life-sustaining or other related applications where a failure or malfunction of component or circuitry may directly or indirectly cause injury or threaten a life without expressed written approval of Rectron Inc. Customers using or selling Rectron components for use in such applications do so at their own risk and shall agree to fully indemnify Rectron Inc and its subsidiaries harmless against all claims, damages and expenditures.

Looking for pricing, stock, or lifecycle information?

Click below to explore more details on WIN SOURCE:

-  [View BZX84C3V0W on WIN SOURCE](#)
-  [Yangzhou yangjie electronic co., ltd Information](#)

Optimize Your Supply Chain with WIN SOURCE Solutions

-  Global Sourcing Solution
-  Obsolete Management
-  Cost Control Management
-  Shortage Management
-  Alternative Solution
-  Excess Inventory Management