





# Bridgelux® V18 Array

Product Data Sheet DS45



BXRE-27X4000

30X4000

35X4000

40X4000

50X4000

# Introduction

V Series

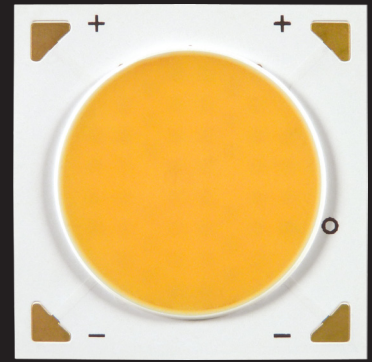

The V Series™ LED Array products deliver high quality light in a compact and cost-effective solid-state lighting package. These Chip-on-Board (CoB) arrays can be efficiently driven at twice the nominal drive current, enabling design flexibility not previously possible. This high flux density light source is designed to support a wide range of high quality, low cost directional luminaires and replacement lamps for commercial and residential applications.

The V18 LED Array is available in a variety of electrical, CCT and CRI combinations providing substantial design flexibility and energy efficiencies.

Lighting system designs incorporating these LED Arrays deliver increased system level efficacy and longer service life. Typical applications include, but are not limited to, replacement lamps, task, accent, spot, track, down light, wide area, security, and wall pack.

## Features

- Market leading efficacy of 130 lm/W typical
- Compact high flux density light source
- Uniform high quality illumination
- Minimum 70, 80 and 90 CRI options
- Streamlined thermal path
- Energy Star / ANSI compliant color binning structure with 3SDCM and 4SDCM options
- More energy efficient than incandescent, halogen and fluorescent lamps
- Low voltage DC operation
- Instant light with unlimited dimming

## Benefits

- Enhanced optical control
- Clean white light without pixilation
- High quality true color reproduction
- Significantly reduced thermal resistance and increased operating temperatures
- Uniform consistent white light
- Lower operating costs
- Easy to use with daylight and motion detectors to enable increased energy savings
- Reduced maintenance costs
- Environmentally friendly, no disposal issue



# Contents

Product Feature Map	2
Product Nomenclature	2
Product Selection Guide	3
Performance at Commonly Used Drive Currents	4
Electrical Characteristics	6
Absolute Maximum Ratings	7
Performance Curves	8
Typical Radiation Pattern	11
Typical Color Spectrum	12
Mechanical Dimensions	13
Color Binning Information	14
Packaging	15
Design Resources	17
Precautions	17
Disclaimers	17
About Bridgelux	18

---



# Product Selection Guide

The following product configurations are available:

**Table 1:** Selection Guide, Pulsed Measurement Data ( $T_j = T_c = 25^\circ\text{C}$ )

Part Number	Nominal CCT <sup>1</sup> (K)	CRI <sup>2</sup>	Nominal Drive Current <sup>3</sup> (mA)	Typical Pulsed Flux <sup>4,5,6</sup> $T_c = 25^\circ\text{C}$ (lm)	Minimum Pulsed Flux <sup>6,7</sup> $T_c = 25^\circ\text{C}$ (lm)	Typical $V_f$ (V)	Typical Power (W)	Typical Efficacy (lm/W)
BXRE-27E4000-F-23	2700	80	1050	3850	3605	29.5	31.0	124
BXRE-27G4000-F-23	2700	90	1050	3100	2832	29.5	31.0	100
BXRE-30E4000-F-23	3000	80	1050	4050	3691	29.5	31.0	131
BXRE-30G4000-F-23	3000	90	1050	3230	2929	29.5	31.0	104
BXRE-35E4000-F-23	3500	80	1050	4150	3760	29.5	31.0	134
BXRE-40E4000-F-23	4000	80	1050	4200	3884	29.5	31.0	135
BXRE-40G4000-F-23	4000	90	1050	3670	3300	29.5	31.0	118
BXRE-50C4000-F-24	5000	70	1050	4430	4000	29.5	31.0	143
BXRE-50E4000-F-24	5000	80	1050	4200	3783	29.5	31.0	136
BXRE-50E4000-F-24	5000	90	1050	3885	3560	29.5	31.0	125

**Table 2:** Selection Guide, Stabilized DC Performance ( $T_c = 85^\circ\text{C}$ )<sup>8,9</sup>

Part Number	Nominal CCT <sup>1</sup> (K)	CRI <sup>2</sup>	Nominal Drive Current <sup>3</sup> (mA)	Typical DC Flux $T_c = 85^\circ\text{C}$ (lm)	Minimum DC Flux <sup>10</sup> $T_c = 85^\circ\text{C}$ (lm)	Typical $V_f$ (V)	Typical Power (W)	Typical Efficacy (lm/W)
BXRE-27E4000-F-23	2700	80	1050	3492	3269	28.6	30.0	116
BXRE-27G4000-F-23	2700	90	1050	2728	2492	28.6	30.0	91
BXRE-30E4000-F-23	3000	80	1050	3662	3337	28.6	30.0	122
BXRE-30G4000-F-23	3000	90	1050	2842	2578	28.6	30.0	95
BXRE-35E4000-F-23	3500	80	1050	3770	3416	28.6	30.0	125
BXRE-40E4000-F-23	4000	80	1050	3793	3508	28.6	30.0	126
BXRE-40G4000-F-23	4000	90	1050	3230	2904	28.6	30.0	108
BXRE-50C4000-F-24	5000	70	1050	3898	3520	28.6	30.0	130
BXRE-50E4000-F-24	5000	80	1050	3696	3329	28.6	30.0	123
BXRE-50E4000-F-24	5000	90	1050	3419	3133	28.6	30.1	114

Notes for Tables 1 & 2:

- Nominal CCT as defined by ANSI C78.377-2011.
- CRI Values are minimums. Minimum R<sub>g</sub> value for 80 CRI products is 0, the minimum R<sub>g</sub> values for 90 CRI products is 50.
- Drive current is referred to as nominal drive current.
- Products tested under pulsed condition (10ms pulse width) at nominal test current where  $T_j$  (junction temperature) =  $T_c$  (case temperature) =  $25^\circ\text{C}$ .
- Typical performance values are provided as a reference only and are not a guarantee of performance.
- Bridgelux maintains a  $\pm 7\%$  tolerance on flux measurements.
- Minimum flux values at the nominal test current are guaranteed by 100% test.
- Typical stabilized DC performance values are provided as reference only and are not a guarantee of performance.
- Typical performance is estimated based on operation under DC (direct current) with LED array mounted onto a heat sink with thermal interface material and the case temperature maintained at  $85^\circ\text{C}$ . Based on Bridgelux test setup, values may vary depending on the thermal design of the luminaire and/or the exposed environment to which the product is subjected.
- Minimum flux values at elevated temperatures are provided for reference only and are not guaranteed by 100% production testing. Based on Bridgelux test setup, values may vary depending on the thermal design of the luminaire and/or the exposed environment to which the product is subjected.

# Performance at Commonly Used Drive Currents

V Series LED arrays are tested to the specifications shown using the nominal drive currents in Table 1. V Series may also be driven at other drive currents dependent on specific application design requirements. The performance at any drive current can be derived from the current vs. voltage characteristics shown in Figures 1 & 2 and the flux vs. current characteristics shown in Figures 3 & 4. The performance at commonly used drive currents is summarized in Table 3.

**Table 3:** Performance at Commonly Used Drive Currents

Part Number	CRI	Drive Current <sup>1</sup> (mA)	Typical $V_f$ $T_c = 25^\circ\text{C}$ (V)	Typical Power $T_c = 25^\circ\text{C}$ (W)	Typical Flux <sup>2</sup> $T_c = 25^\circ\text{C}$ (lm)	Typical DC Flux <sup>3</sup> $T_c = 85^\circ\text{C}$ (lm)	Typical Efficacy $T_c = 25^\circ\text{C}$ (lm/W)
BXRE-27E4000-F-23	80	500	28.1	14.1	1985	1761	141
		700	28.7	20.1	2701	2398	134
		<b>1050</b>	<b>29.5</b>	<b>31.0</b>	<b>3850</b>	<b>3427</b>	<b>124</b>
		1400	30.2	42.3	4891	4365	116
		2100	31.6	66.4	6587	5925	99
BXRE-27G4000-F-23	90	500	28.1	14.1	1598	1401	114
		700	28.7	20.1	2175	1907	108
		<b>1050</b>	<b>29.5</b>	<b>31.0</b>	<b>3100</b>	<b>2726</b>	<b>100</b>
		1400	30.2	42.3	3938	3472	93
		2100	31.6	66.4	5304	4713	80
BXRE-30E4000-F-23	80	500	28.1	14.1	2088	1871	149
		700	28.7	20.1	2841	2548	141
		<b>1050</b>	<b>29.5</b>	<b>31.0</b>	<b>4027</b>	<b>3641</b>	<b>131</b>
		1400	30.2	42.3	5145	4638	122
		2100	31.6	66.4	6929	6296	104
BXRE-30G4000-F-23	90	500	28.1	14.1	1665	1470	119
		700	28.7	20.1	2266	2002	113
		<b>1050</b>	<b>29.5</b>	<b>31.0</b>	<b>3230</b>	<b>2862</b>	<b>104</b>
		1400	30.2	42.3	4103	3645	97
		2100	31.6	66.4	5526	4948	83
BXRE-35E4000-F-23	80	500	28.1	14.1	2139	1909	152
		700	28.7	20.1	2912	2599	145
		<b>1050</b>	<b>29.5</b>	<b>31.0</b>	<b>4150</b>	<b>3715</b>	<b>134</b>
		1400	30.2	42.3	5272	4731	125
		2100	31.6	66.4	7100	6422	107

Notes for Table 3:

1. Alternate drive currents in Table 3 are provided for reference only and are not a guarantee of performance.
2. Bridgelux maintains a  $\pm 7\%$  tolerance on flux measurements.
3. Typical stabilized DC performance values are provided as reference only and are not a guarantee of performance.

# Performance at Commonly Used Drive Currents

**Table 3:** Performance at Commonly Used Drive Currents (Continued)

Part Number	CRI	Drive Current <sup>1</sup> (mA)	Typical $V_f$ $T_c = 25^\circ\text{C}$ (V)	Typical Power $T_c = 25^\circ\text{C}$ (W)	Typical Flux <sup>2</sup> $T_c = 25^\circ\text{C}$ (lm)	Typical DC Flux <sup>3</sup> $T_c = 85^\circ\text{C}$ (lm)	Typical Efficacy $T_c = 25^\circ\text{C}$ (lm/W)
BXRE-40E4000-F-23	80	500	28.1	14.1	2165	1926	153
		700	28.7	20.1	2947	2623	146
		<b>1050</b>	<b>29.5</b>	<b>31.0</b>	<b>4200</b>	<b>3749</b>	<b>135</b>
		1400	30.2	42.3	5336	4775	125
		2100	31.6	66.4	7186	6482	107
BXRE-40G4000-F-23	90	500	28.1	14.1	1892	1653	135
		700	28.7	20.1	2575	2250	128
		<b>1050</b>	<b>29.5</b>	<b>31.0</b>	<b>3670</b>	<b>3216</b>	<b>118</b>
		1400	30.2	42.3	4662	4097	110
		2100	31.6	66.4	6279	5561	95
BXRE-50C4000-F-24	70	500	28.1	14.1	2283	2003	163
		700	28.7	20.1	3108	2727	155
		<b>1050</b>	<b>29.5</b>	<b>31.0</b>	<b>4430</b>	<b>3898</b>	<b>143</b>
		1400	30.2	42.3	5628	4964	133
		2100	31.6	66.4	7579	6739	114
BXRE-50E4000-F-24	80	500	28.1	14.1	2165	1877	154
		700	28.7	20.1	2947	2556	147
		<b>1050</b>	<b>29.5</b>	<b>31.0</b>	<b>4200</b>	<b>3653</b>	<b>136</b>
		1400	30.2	42.3	5336	4653	126
		2100	31.6	66.4	7186	6316	108
BXRE-50G4000-F-24	90	500	28.1	14.1	2003	1751	143
		700	28.7	20.1	2726	2384	136
		<b>1050</b>	<b>29.5</b>	<b>31.0</b>	<b>3885</b>	<b>3407</b>	<b>125</b>
		1400	30.2	42.3	4936	4340	117
		2100	31.6	66.4	6647	5891	100

Notes for Table 3:

1. Alternate drive currents in Table 3 are provided for reference only and are not a guarantee of performance.
2. Bridgelux maintains a  $\pm 7\%$  tolerance on flux measurements.
3. Typical stabilized DC performance values are provided as reference only and are not a guarantee of performance.

# Electrical Characteristics

**Table 4:** Electrical Characteristics

Part Number	Drive Current (mA)	Forward Voltage Pulsed, $T_c = 25^\circ\text{C}$ (V) <sup>1, 2, 3</sup>			Typical Coefficient of Forward Voltage <sup>4</sup> $\Delta V_f / \Delta T$ (mV/ $^\circ\text{C}$ )	Typical Thermal Resistance Junction to Case <sup>5, 6</sup> $R_{j-c}$ (C/W)	Driver Selection Voltages <sup>7</sup> (V)	
		Minimum	Typical	Maximum			$V_f$ Min. Hot $T_c = 105^\circ\text{C}$ (V)	$V_f$ Max. Cold $T_c = -40^\circ\text{C}$ (V)
BXRE-xxx4000-F-2x	1050	27.3	29.5	31.7	-15	0.13	26.1	32.7
	2100	29.2	31.6	34.2	-15	0.17	28.0	35.2

Notes for Table 4:

- Parts are tested in pulsed conditions,  $T_c = 25^\circ\text{C}$ . Pulse width is 10ms.
- Voltage minimum and maximum are provided for reference only and are not a guarantee of performance.
- Bridgelux maintains a tester tolerance of  $\pm 0.10\text{V}$  on forward voltage measurements.
- Typical coefficient of forward voltage tolerance is  $\pm 0.1\text{mV}$  for nominal current.
- Thermal resistance values are based from test data of a 3000K 80 CRI product.
- Thermal resistance value was calculated using total electrical input power; optical power was not subtracted from input power. The thermal interface material used during testing is not included in the thermal resistance value.
- $V_f$  min hot and max cold values are provided as reference only and are not guaranteed by test. These values are provided to aid in driver design and selection over the operating range of the product.

# Absolute Maximum Ratings

**Table 5:** Maximum Ratings

Parameter	Maximum Rating
LED Junction Temperature ( $T_j$ )	150°C
Storage Temperature	-40°C to +105°C
Operating Case Temperature <sup>1</sup> ( $T_c$ )	105°C
Soldering Temperature <sup>2</sup>	350°C or lower for a maximum of 10 seconds
Maximum Drive Current <sup>3,4,5</sup>	2100mA
Maximum Peak Pulsed Drive Current <sup>6</sup>	3000mA
Maximum Reverse Voltage <sup>7</sup>	-55V

Notes for Table 5:

1. For IEC 62717 requirement, please consult your Bridgelux sales representative.
2. Refer to Bridgelux Application Note AN41: Assembly Considerations for Bridgelux V Series LED Arrays.
3. DC Forward Current for LM-80 is the maximum drive current for which LM-80 data is currently available.
4. Lumen maintenance (L70) and lifetime predictions are valid for drive current and case temperature conditions used for LM-80 testing as included in the applicable LM-80 test report for these arrays. Contact your Bridgelux sales representatives for LM-80 report.
5. Arrays may be driven at higher currents however lumen maintenance may be reduced.
6. Bridgelux recommends a maximum duty cycle of 10% and pulse width of 20 ms when operating LED Arrays at maximum peak pulsed current specified. Maximum peak pulsed currents indicate values where LED Arrays can be driven without catastrophic failures.
7. Light emitting diodes are not designed to be driven in reverse voltage and will not produce light under this condition. Maximum rating provided for reference only.

# Performance Curves

Figure 1: Drive Current vs. Voltage ( $T_j = T_c = 25^\circ\text{C}$ )

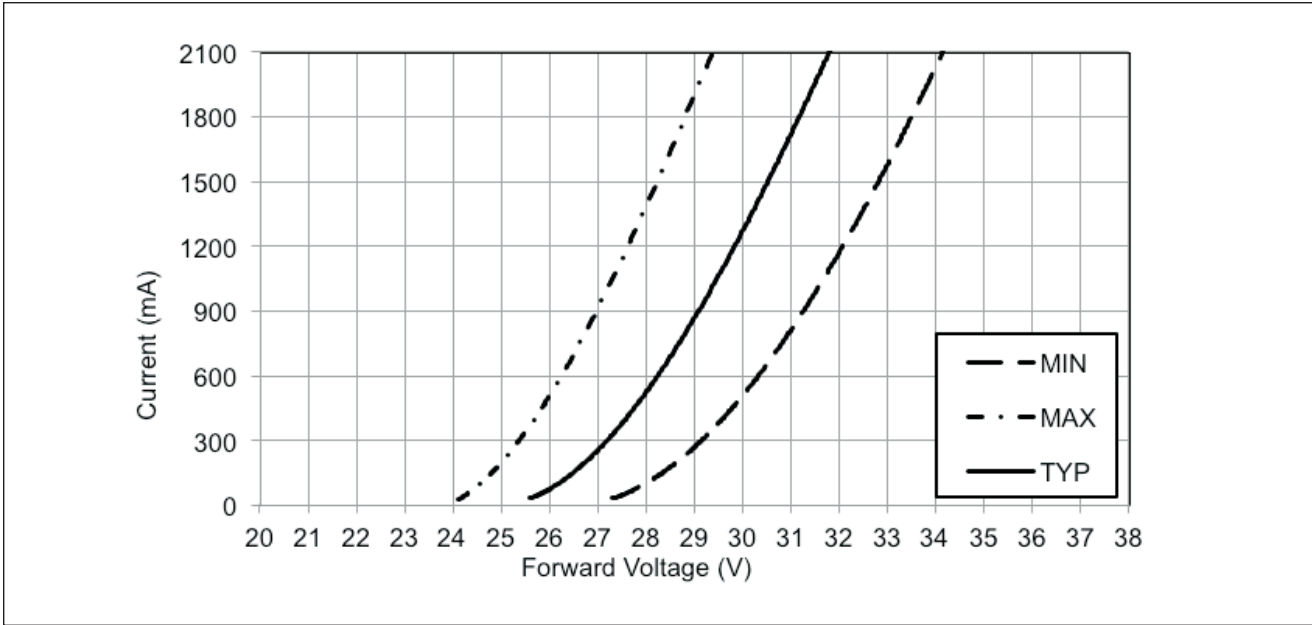
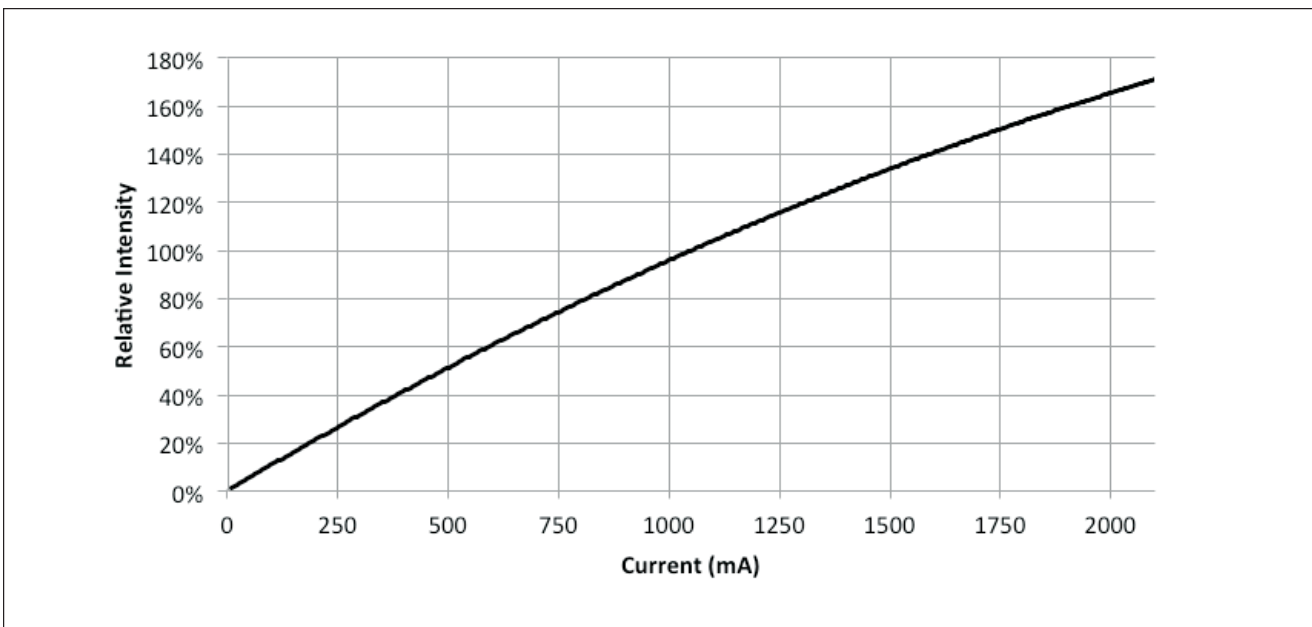

Figure 2: Typical Relative Luminous Flux vs. Drive Current ( $T_j = T_c = 25^\circ\text{C}$ )



Note for Figure 2:

1. Bridgelux does not recommend driving high power LEDs at low currents. Doing so may produce unpredictable results. Pulse width modulation (PWM) is recommended for dimming effects.

# Performance Curves

**Figure 3: Typical DC Flux vs. Case Temperature**

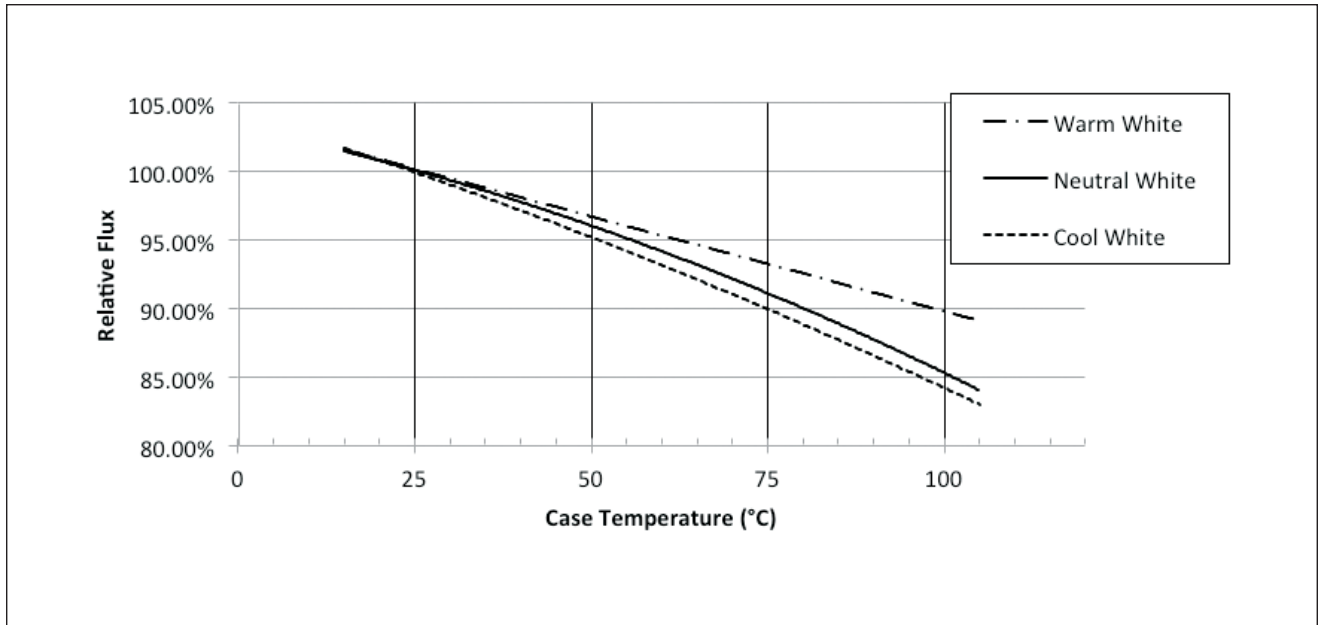

**Figure 4: Typical DC ccy Shift vs. Case Temperature**

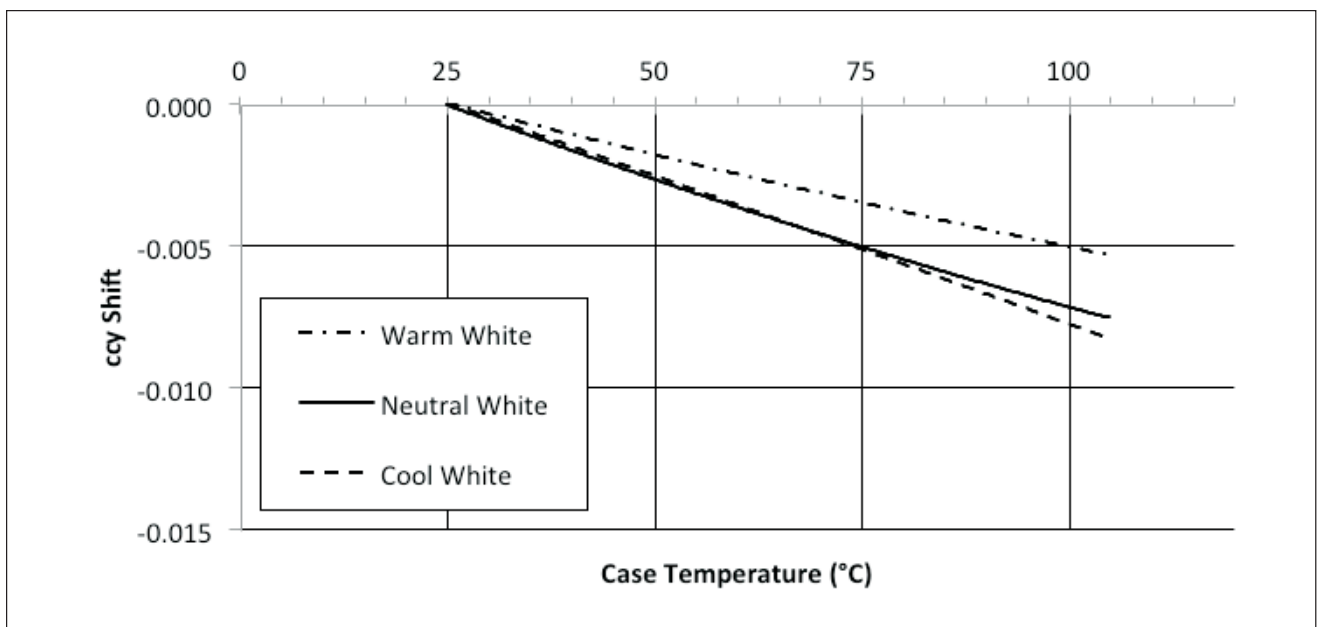

Notes for Figures 3-4:

1. Characteristics shown for warm white based on 3000K and 80 CRI.
2. Characteristics shown for neutral white based on 4000K and 80 CRI.
3. Characteristics shown for cool white based on 5000K and 70 CRI.
4. For other color SKUs, the shift in color will vary. Please contact your Bridgelux Sales Representative for more information.

# Performance Curves

Figure 5: Typical DC ccx Shift vs. Case Temperature

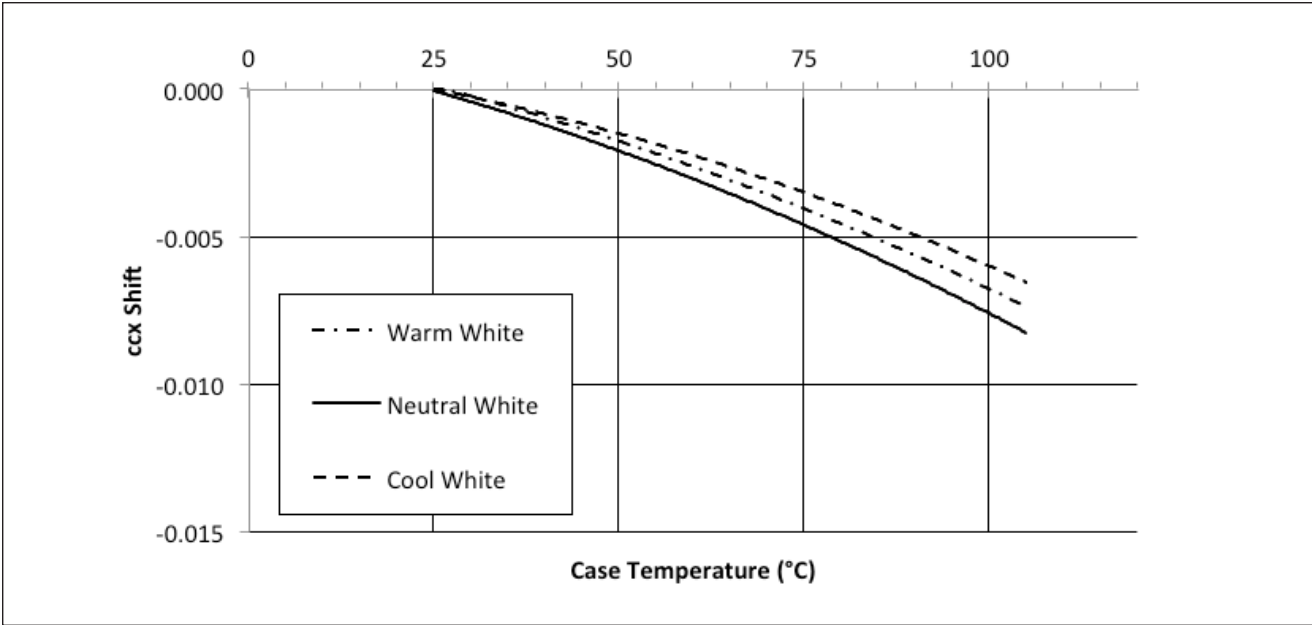

Notes for Figure 5:

- 1. Characteristics shown for warm white based on 3000K and 80 CRI.
- 2. Characteristics shown for neutral white based on 4000K and 80 CRI.
- 3. Characteristics shown for cool white based on 5000K and 70 CRI.
- 4. For other color SKUs, the shift in color will vary. Please contact your Bridgelux Sales Representative for more information.

# Typical Radiation Pattern

Figure 6: Typical Spatial Radiation Pattern

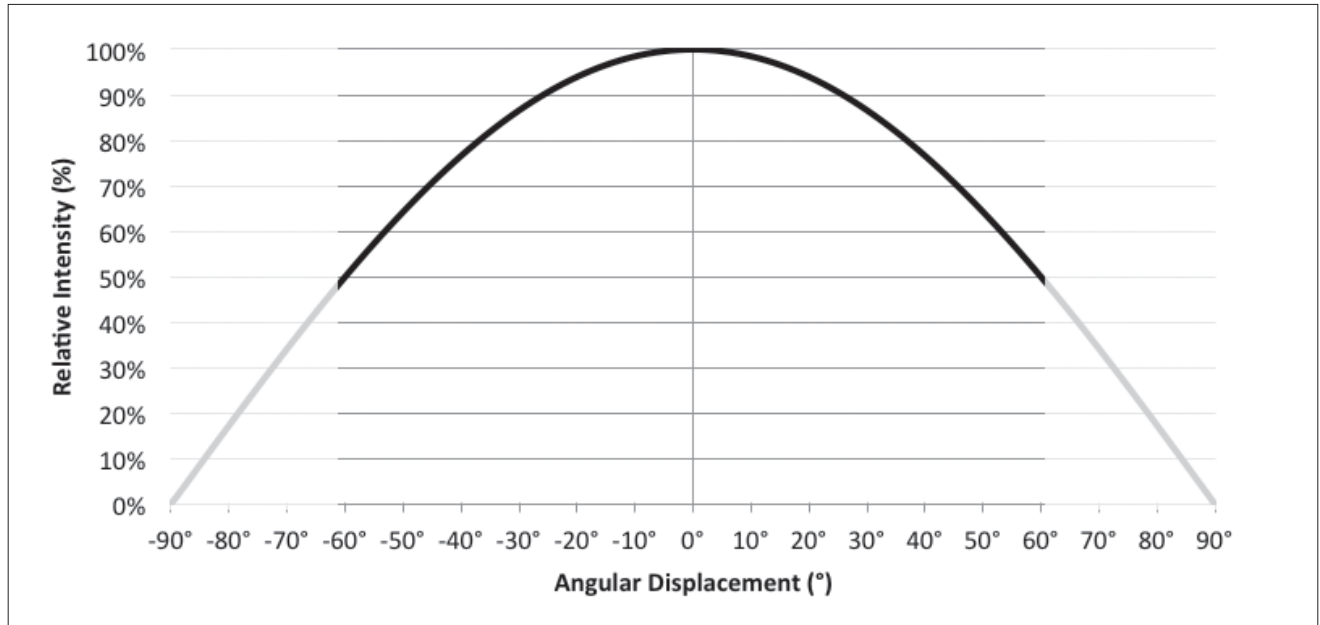

Note for Figure 6:

1. Typical viewing angle is 120°.
2. The viewing angle is defined as the off axis angle from the centerline where  $I_v$  is  $\frac{1}{2}$  of the peak value.

Figure 7: Typical Polar Radiation Pattern

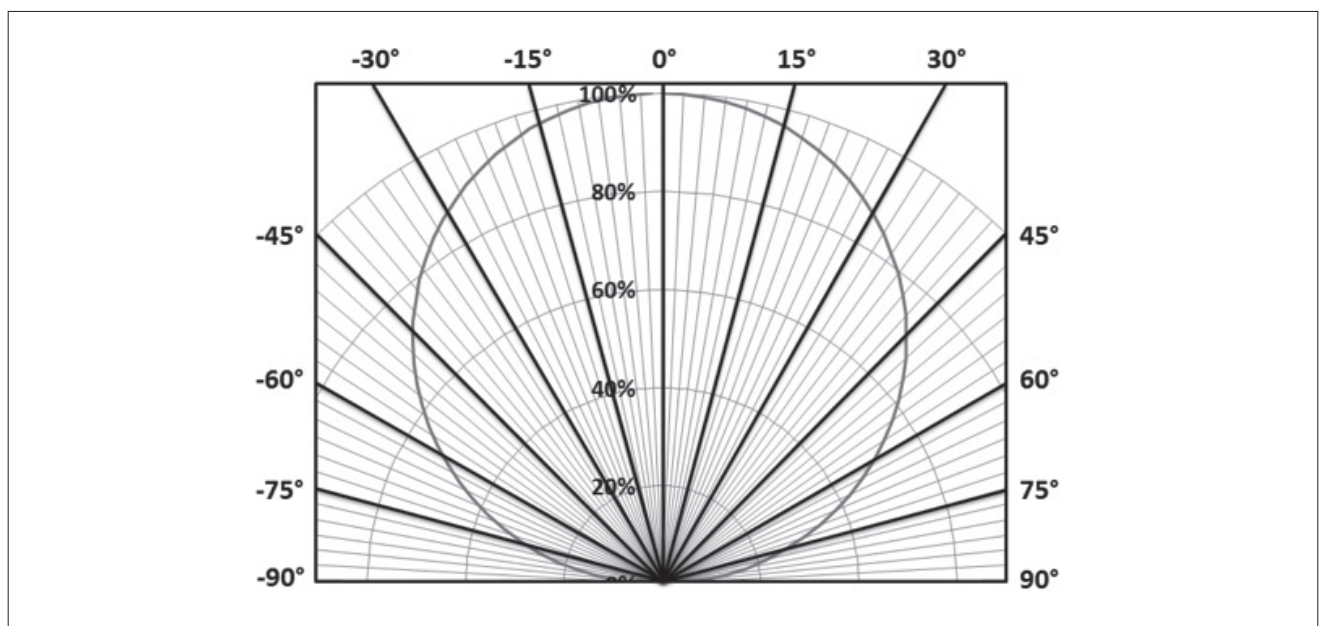

# Typical Color Spectrum

Figure 8: Typical Color Spectrum

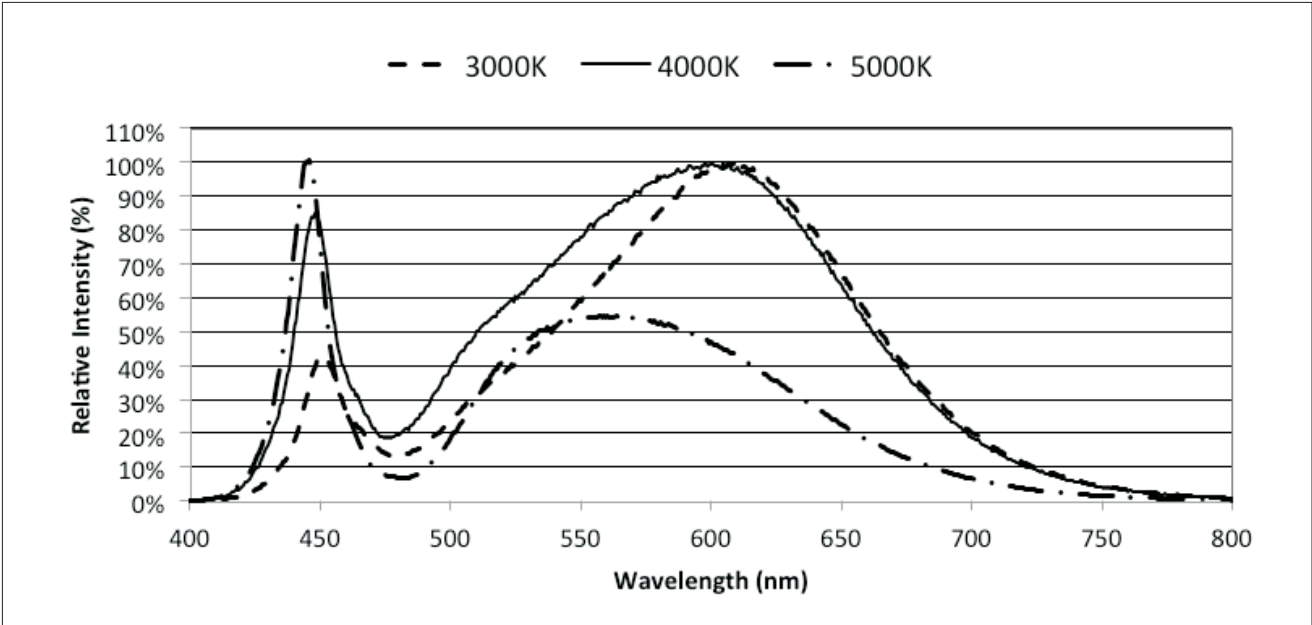

Notes for Figure 8:

- 1. Color spectra measured at nominal current for  $T_j = T_c = 25^\circ\text{C}$ .
- 2. Color spectra shown for warm white is 3000K and 80 CRI.
- 3. Color spectra shown for neutral white is 4000K and 80 CRI.
- 4. Color spectra shown for cool white is 5000K and 70 CRI.

# Mechanical Dimensions

Figure 9: Drawing for V18 LED Array

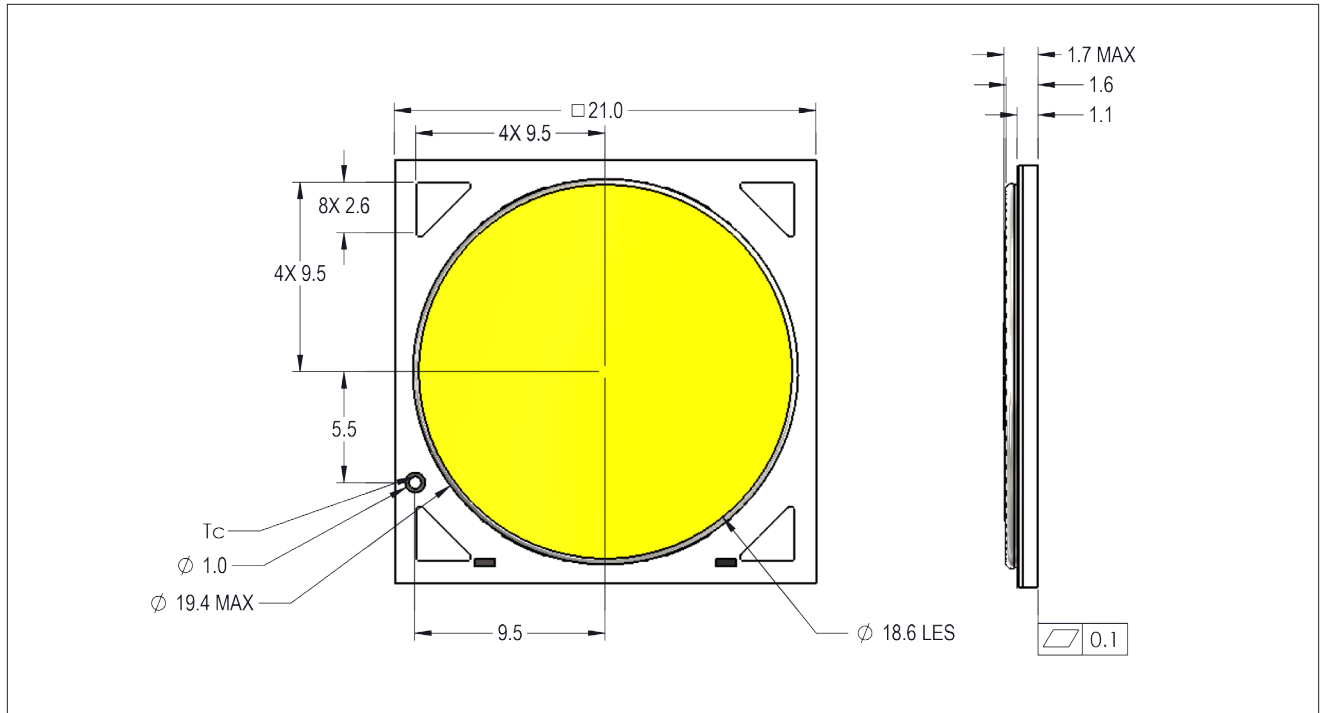

Notes for Figure 9:

1. Solder pads are labeled "+" and "-" to denote positive and negative polarity, respectively.
2. It is not necessary to provide electrical connections to both sets of solder pads. Either set may be used depending on application specific design requirements.
3. Drawings are not to scale.
4. Drawing dimensions are in millimeters.
5. Unless otherwise specified, tolerances are  $\pm 0.10$ mm.
6. The optical center of the LED Array is nominally defined by the mechanical center of the array. The light emitting surface (LES) is centered on the mechanical center of the array to a tolerance of  $\pm 0.45$  mm
7. Bridgelux maintains a flatness of 0.1 mm across the mounting surface of the array. Refer to Application Notes AN40 and AN41 for product handling, mounting and heat sink recommendations.

# Color Binning Information

**Figure 10: Graph of Warm and Neutral White Test Bins in xy Color Space**

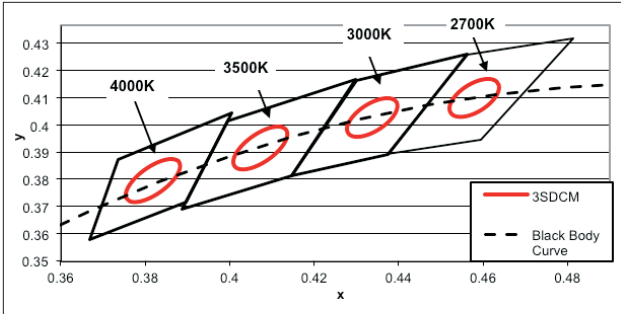

Note: Pulsed Test Conditions,  $T_c = 25^\circ\text{C}$

**Table 6: Warm and Neutral White xy Bin Coordinates and Associated Typical CCT**

Bin Code	2700K	3000K	3500K	4000K
ANSI Bin (for reference only)	(2580K - 2870K)	(2870K - 3220K)	(3220K - 3710K)	(3710K - 4260K)
o3 (3SDCM)	(2651K - 2794K)	(2968K - 3136K)	(3369K - 3586K)	(3851K - 4130K)
o2 (2SDCM)	(2674K - 2769K)	(2995K - 3107K)	(3404K - 3548K)	(3895K - 4081K)
Center Point (x,y)	(0.4578, 0.4101)	(0.4338, 0.403)	(0.4073, 0.3917)	(0.3818, 0.3797)

**Figure 11: Graph of Cool White Test Bins in xy Color Space**

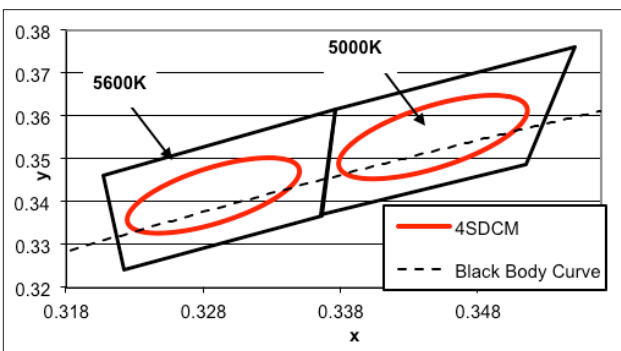

Note: Pulsed Test Conditions,  $T_c = 25^\circ\text{C}$

**Table 7: Cool White xy Bin Coordinates and Associated Typical CCT**

Bin Code	5000K	5600K
ANSI Bin (for reference only)	(4745K - 5311K)	(5310K - 6020K)
o4 (4SDCM)	(4801K - 5282K)	(5475K - 5830K)
Center Point (x,y)	(0.3447, 0.3553)	(0.3293, 0.3423)

# Packaging

Figure 12: Drawing for V Series Packaging Tray

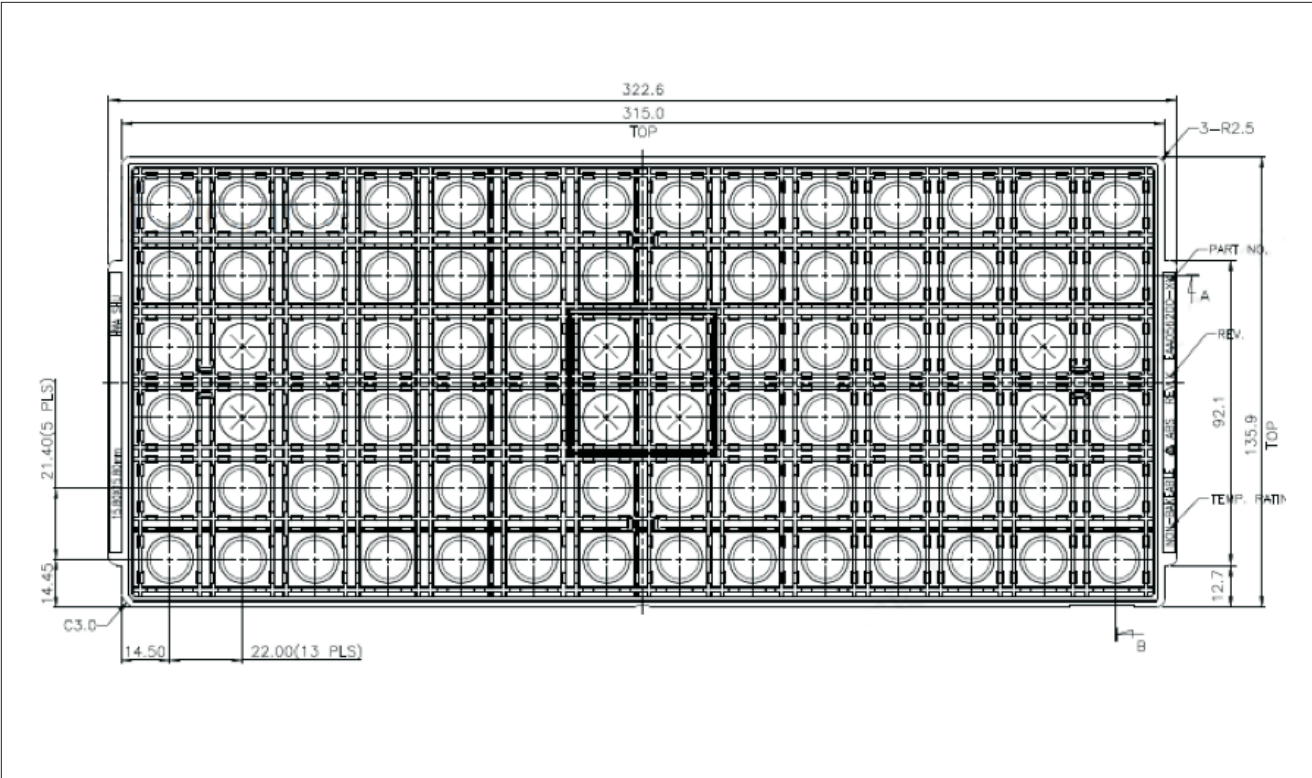

Notes for Figure 12:

1. Dimensions are in millimeters
2. Tolerances: XX ± 0.25, XXX ± 0.13, X'0' = ±0'30'
3. Trays are stackable without interference and will not stick together during unstacking operation

# Packaging

Figure 13: V Series Packaging and Labeling

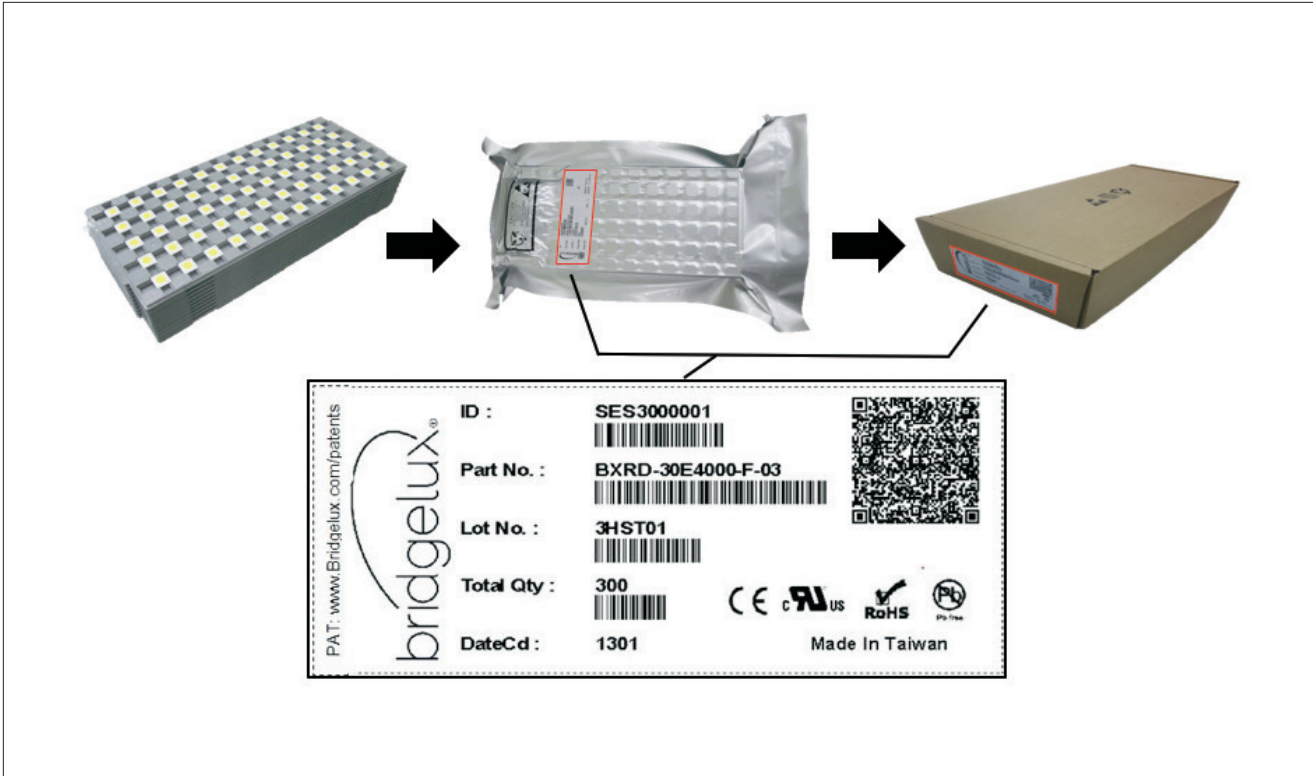

Notes for Figure 13:

1. Each tray holds 60 LEDs. 10 trays are stacked and one empty tray placed on top to cover the top tray.
2. Stacked trays are to contain only 1 part number and be vacuum sealed in an anti-static bag and placed in its own individual box.
3. Each bag and box is to be labeled as shown above.

# Design Resources

## Application Notes

Bridgelux has developed a comprehensive set of application notes and design resources to assist customers in successfully designing with the V Series product family of LED array products. For a list of resources under development, visit [www.bridgelux.com](http://www.bridgelux.com).

## Optical Source Models

Optical source models and ray set files are available for all Bridgelux products. For a list of available formats, visit [www.bridgelux.com](http://www.bridgelux.com).

## 3D CAD Models

Three dimensional CAD models depicting the product outline of all Bridgelux V Series LED arrays are available in both SAT and STEP formats. Please contact your Bridgelux sales representative for assistance.

# Precautions

## CAUTION: CHEMICAL EXPOSURE HAZARD

Exposure to some chemicals commonly used in luminaire manufacturing and assembly can cause damage to the LED array. Please consult Bridgelux Application Note AN41 for additional information.

## CAUTION: EYE SAFETY

Eye safety classification for the use of Bridgelux V Series LED arrays is in accordance with IEC specification EN62471: Photobiological Safety of Lamps and Lamp Systems. V Series LED arrays are classified as Risk Group 1 (Low Risk) when operated at or below the maximum drive current. Please use appropriate precautions. It is important that employees working with LEDs are trained to use them safely.

## CAUTION: RISK OF BURN

Do not touch the V Series LED array or yellow resin area during operation. Allow the array to cool for a sufficient period of time before handling. The V Series LED array may reach elevated temperatures such that could burn skin when touched.

## CAUTION

### CONTACT WITH LIGHT EMITTING SURFACE (LES)

Avoid any contact with the LES. Do not touch the LES of the LED array or apply stress to the LES (yellow phosphor resin area). Contact may cause damage to the LED array.

Optics and reflectors must not be mounted in contact with the LES (yellow phosphor resin area). Optical devices may be mounted on the top surface of the plastic housing of the V Series LED array. Use the mechanical features of the LED array housing, edges and/or mounting holes to locate and secure optical devices as needed.

# Disclaimers

## MINOR PRODUCT CHANGE POLICY

The rigorous qualification testing on products offered by Bridgelux provides performance assurance. Slight cosmetic changes that do not affect form, fit, or function may occur as Bridgelux continues product optimization.

## STANDARD TEST CONDITIONS

Unless otherwise stated, array testing is performed at the nominal drive current.

# About Bridgelux

Bridgelux is a leading developer and manufacturer of technologies and solutions transforming the \$40 billion global lighting industry into a \$100 billion market opportunity. Based in Livermore, California, Bridgelux is a pioneer in solid state lighting (SSL), expanding the market for light emitting diode (LED) technologies by driving down the cost of LED lighting systems. Bridgelux's patented light source technology replaces traditional technologies (such as incandescent, halogen, fluorescent and high intensity discharge lighting) with integrated, solid state lighting solutions that enable lamp and luminaire manufacturers to provide high performance and energy efficient white light for the rapidly growing interior and exterior lighting markets, including street lights, commercial lighting and consumer applications.

**For more information about the company,  
please visit [bridgelux.com](http://bridgelux.com).**



101 Portola Avenue  
Livermore, CA 94551  
Tel (925) 583-8400  
Fax (925) 583-8410  
[www.bridgelux.com](http://www.bridgelux.com)

© 2015 Bridgelux, Inc. All rights reserved 2015. Product specifications are subject to change without notice. Bridgelux, the Bridgelux stylized logo design and V Series are registered trademarks, and Decor Series is a trademark of Bridgelux, Inc. All other trademarks are the property of their respective owners.

Bridgelux V18 Array Series Product Data Sheet DS45 Rev. A (02/2015)

## Looking for pricing, stock, or lifecycle information?

Click below to explore more details on WIN SOURCE:

 [View BXRE-27G4000-F-23 on WIN SOURCE](#)

 [Bridgelux Information](#)

## Optimize Your Supply Chain with WIN SOURCE Solutions

-  Global Sourcing Solution
-  Obsolete Management
-  Cost Control Management
-  Shortage Management
-  Alternative Solution
-  Excess Inventory Management