



# THE DATASHEET OF BAV301-TR3





## Small Signal Switching Diodes, High Voltage



### FEATURES

- Silicon epitaxial planar diodes
- Saving space
- Hermetic sealed parts
- Fits onto SOD-323/SOT-23 footprints
- Electrical data identical with the devices BAV100 to BAV103, BAV200 to BAV203
- AEC-Q101 qualified
- Material categorization: for definitions of compliance please see [www.vishay.com/doc?99912](http://www.vishay.com/doc?99912)



**RoHS**  
COMPLIANT  
HALOGEN  
**FREE**

**DESIGN SUPPORT TOOLS** click logo to get started



### APPLICATIONS

- General purposes

### MECHANICAL DATA

**Case:** MicroMELF

**Weight:** approx. 12 mg

**Cathode band color:** black

**Packaging codes / options:**

TR3/10K per 13" reel (8 mm tape), 10K/box

TR/2.5K per 7" reel (8 mm tape), 12.5K/box

PARTS TABLE				
PART	TYPE DIFFERENTIATION	ORDERING CODE	CIRCUIT CONFIGURATION	REMARKS
BAV300	$V_{RRM} = 60\text{ V}$	BAV300-TR3 or BAV300-TR	Single	Tape and reel
BAV301	$V_{RRM} = 120\text{ V}$	BAV301-TR3 or BAV301-TR	Single	Tape and reel
BAV302	$V_{RRM} = 200\text{ V}$	BAV302-TR3 or BAV302-TR	Single	Tape and reel
BAV303	$V_{RRM} = 250\text{ V}$	BAV303-TR3 or BAV303-TR	Single	Tape and reel

ABSOLUTE MAXIMUM RATINGS ( $T_{amb} = 25\text{ }^{\circ}\text{C}$ , unless otherwise specified)					
PARAMETER	TEST CONDITION	PART	SYMBOL	VALUE	UNIT
Repetitive peak reverse voltage		BAV300	$V_{RRM}$	60	V
		BAV301	$V_{RRM}$	120	V
		BAV302	$V_{RRM}$	200	V
		BAV303	$V_{RRM}$	250	V
Reverse voltage		BAV300	$V_R$	50	V
		BAV301	$V_R$	100	V
		BAV302	$V_R$	150	V
		BAV303	$V_R$	200	V
Forward continuous current			$I_F$	250	mA
Peak forward surge current	$t_p = 1\text{ s}, T_j = 25\text{ }^{\circ}\text{C}$		$I_{FSM}$	1	A
Forward peak current	$f = 50\text{ Hz}$		$I_{FM}$	625	mA



<b>THERMAL CHARACTERISTICS</b> ( $T_{amb} = 25\text{ }^{\circ}\text{C}$ , unless otherwise specified)				
PARAMETER	TEST CONDITION	SYMBOL	VALUE	UNIT
Thermal resistance junction to ambient air	Mounted on epoxy-glass hard tissue, fig. 4 35 $\mu\text{m}$ copper clad, 0.9 $\text{mm}^2$ copper area per electrode	$R_{thJA}$	500	K/W
Junction temperature		$T_j$	175	$^{\circ}\text{C}$
Storage temperature range		$T_{stg}$	-65 to +175	$^{\circ}\text{C}$

<b>ELECTRICAL CHARACTERISTICS</b> ( $T_{amb} = 25\text{ }^{\circ}\text{C}$ , unless otherwise specified)							
PARAMETER	TEST CONDITION	PART	SYMBOL	MIN.	TYP.	MAX.	UNIT
Forward voltage	$I_F = 100\text{ mA}$		$V_F$			1	V
Reverse current	$V_R = 50\text{ V}$	BAV300	$I_R$			100	nA
	$V_R = 100\text{ V}$	BAV301	$I_R$			100	nA
	$V_R = 150\text{ V}$	BAV302	$I_R$			100	nA
	$V_R = 200\text{ V}$	BAV303	$I_R$			100	nA
	$T_j = 100\text{ }^{\circ}\text{C}$ , $V_R = 50\text{ V}$	BAV300	$I_R$			15	$\mu\text{A}$
	$T_j = 100\text{ }^{\circ}\text{C}$ , $V_R = 100\text{ V}$	BAV301	$I_R$			15	$\mu\text{A}$
	$T_j = 100\text{ }^{\circ}\text{C}$ , $V_R = 150\text{ V}$	BAV302	$I_R$			15	$\mu\text{A}$
	$T_j = 100\text{ }^{\circ}\text{C}$ , $V_R = 200\text{ V}$	BAV303	$I_R$			15	$\mu\text{A}$
Breakdown voltage	$I_R = 100\text{ }\mu\text{A}$ , $t_p/T = 0.01$ , $t_p = 0.3\text{ ms}$	BAV300	$V_{(BR)}$	60			V
		BAV301	$V_{(BR)}$	120			V
		BAV302	$V_{(BR)}$	200			V
		BAV303	$V_{(BR)}$	250			V
Diode capacitance	$V_R = 0\text{ V}$ , $f = 1\text{ MHz}$		$C_D$		1.5		pF
Differential forward resistance	$I_F = 10\text{ mA}$		$r_f$		5		$\Omega$
Reverse recovery time	$I_F = I_R = 30\text{ mA}$ , $i_R = 3\text{ mA}$ , $R_L = 100\text{ }\Omega$		$t_{rr}$			50	ns

## TYPICAL CHARACTERISTICS ( $T_{amb} = 25\text{ }^{\circ}\text{C}$ , unless otherwise specified)

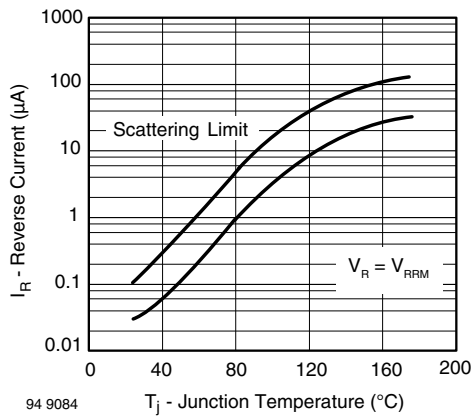

Fig. 1 - Reverse Current vs. Junction Temperature

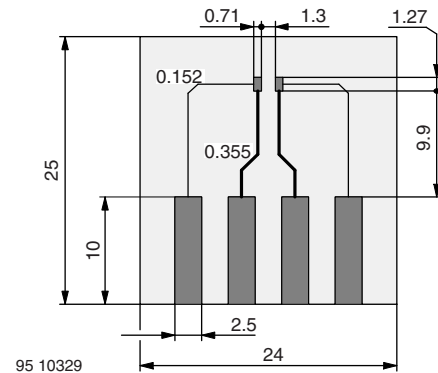

Fig. 4 - Board for  $R_{thJA}$  Definition (in mm)

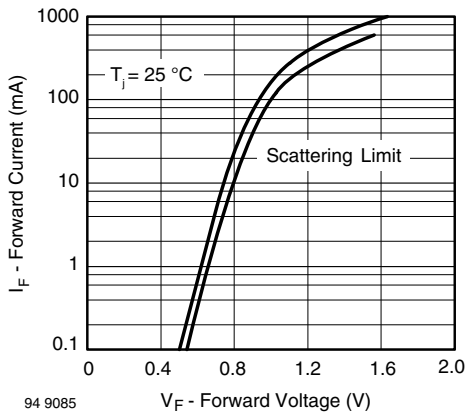

Fig. 2 - Forward Current vs. Forward Voltage

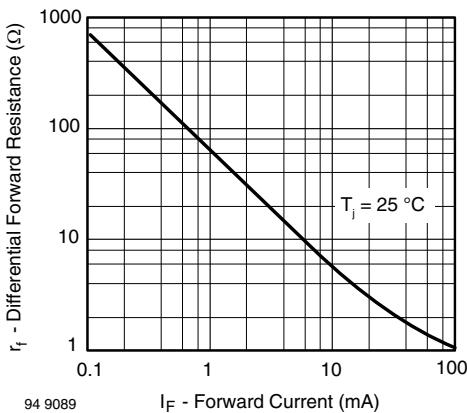
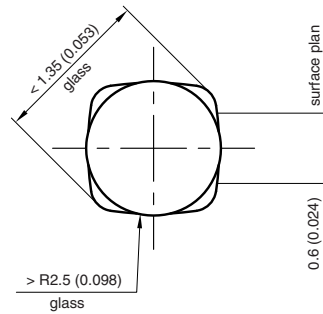
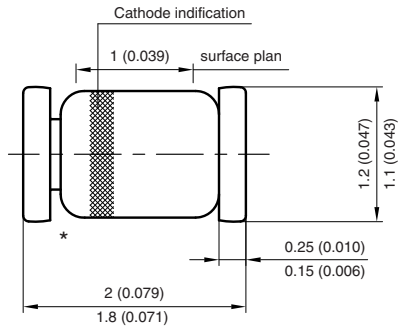

Fig. 3 - Differential Forward Resistance vs. Forward Current



PACKAGE DIMENSIONS in millimeters (inches): **MicromELF**



\* The gap between plug and glass can be either on cathode or anode side

Foot print recommendation:

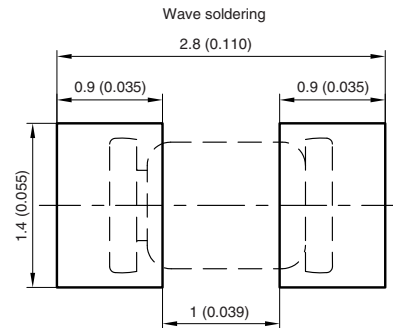
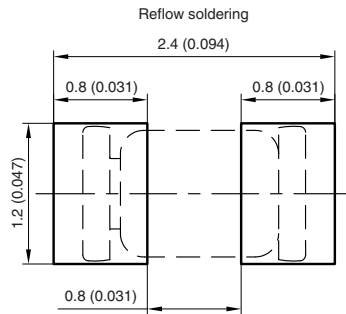

Created - Date: 26.July.1996  
Rev. 13 - Date: 07.June.2006  
Document no.:6.560-5007.01-4  
96 12072



## **Disclaimer**

ALL PRODUCT, PRODUCT SPECIFICATIONS AND DATA ARE SUBJECT TO CHANGE WITHOUT NOTICE TO IMPROVE RELIABILITY, FUNCTION OR DESIGN OR OTHERWISE.

Vishay Intertechnology, Inc., its affiliates, agents, and employees, and all persons acting on its or their behalf (collectively, "Vishay"), disclaim any and all liability for any errors, inaccuracies or incompleteness contained in any datasheet or in any other disclosure relating to any product.

Vishay makes no warranty, representation or guarantee regarding the suitability of the products for any particular purpose or the continuing production of any product. To the maximum extent permitted by applicable law, Vishay disclaims (i) any and all liability arising out of the application or use of any product, (ii) any and all liability, including without limitation special, consequential or incidental damages, and (iii) any and all implied warranties, including warranties of fitness for particular purpose, non-infringement and merchantability.

Statements regarding the suitability of products for certain types of applications are based on Vishay's knowledge of typical requirements that are often placed on Vishay products in generic applications. Such statements are not binding statements about the suitability of products for a particular application. It is the customer's responsibility to validate that a particular product with the properties described in the product specification is suitable for use in a particular application. Parameters provided in datasheets and / or specifications may vary in different applications and performance may vary over time. All operating parameters, including typical parameters, must be validated for each customer application by the customer's technical experts. Product specifications do not expand or otherwise modify Vishay's terms and conditions of purchase, including but not limited to the warranty expressed therein.

Except as expressly indicated in writing, Vishay products are not designed for use in medical, life-saving, or life-sustaining applications or for any other application in which the failure of the Vishay product could result in personal injury or death. Customers using or selling Vishay products not expressly indicated for use in such applications do so at their own risk. Please contact authorized Vishay personnel to obtain written terms and conditions regarding products designed for such applications.

No license, express or implied, by estoppel or otherwise, to any intellectual property rights is granted by this document or by any conduct of Vishay. Product names and markings noted herein may be trademarks of their respective owners.

## Looking for pricing, stock, or lifecycle information?

Click below to explore more details on WIN SOURCE:

 [View BAV301-TR3 on WIN SOURCE](#)

 [Vishay Information](#)

## Optimize Your Supply Chain with WIN SOURCE Solutions

-  Global Sourcing Solution
-  Obsolete Management
-  Cost Control Management
-  Shortage Management
-  Alternative Solution
-  Excess Inventory Management