



**THE DATASHEET OF
BM28B0.6-50DS/2-0.35V(51)**



BM28 Series

0.35mm Pitch, 0.6mm Stacking Height, FPC-to-Board Connectors Supporting Up to 5A



Power / Signal



Robust



Compact

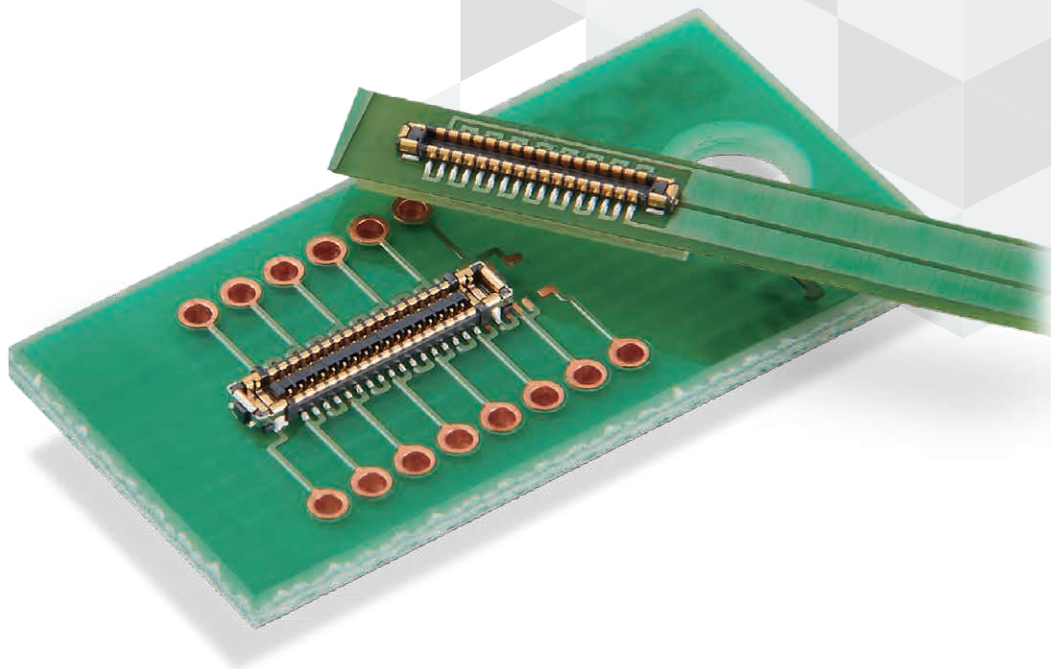

Features

1. 5A Rated Current

2 Power contacts up to 5A with 0.2A contacts for signal, space-saving connector.

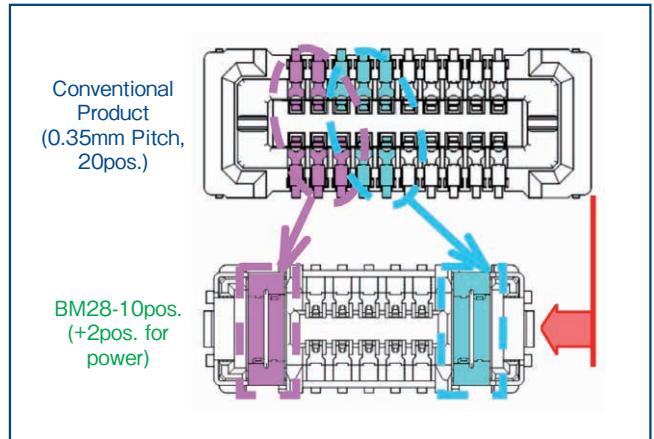

Power Lines are Concentrated into 2 Power Contacts Instead of Conventional Multiple Signal Contacts.

2. Highly Reliable Contact Design

2-point contact design for both power and signal ensures a highly reliable contact.

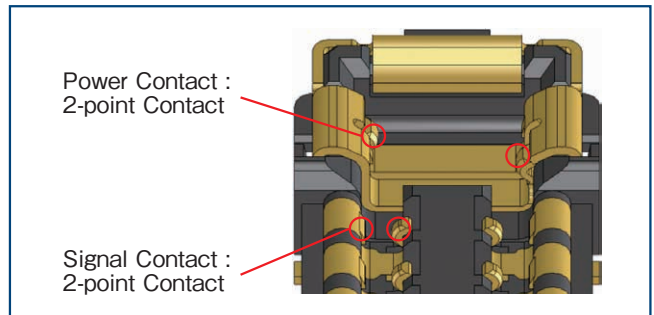

3. Superior Mating Operability

Guide ribs ensure 0.3mm self-alignment. Clear tactile click prevents partial mating, increases mating operability.

4. Supports USB4 Gen.2 (20Gbps) Transmission

Signal contacts support USB4 Gen.2 (20Gbps) transmission signals.

5. Environmental Compatibility

· Halogen Free
Connector does not contain chlorine or bromine exceeding the standard value.

* As defined by IEC 61249-2-21
Br : 900ppm max., Cl : 900ppm max., Br+Cl : 1500ppm max.

Applications

Devices that require low-profile, compact design such as mobile phone, wearable terminals and tablet PCs.

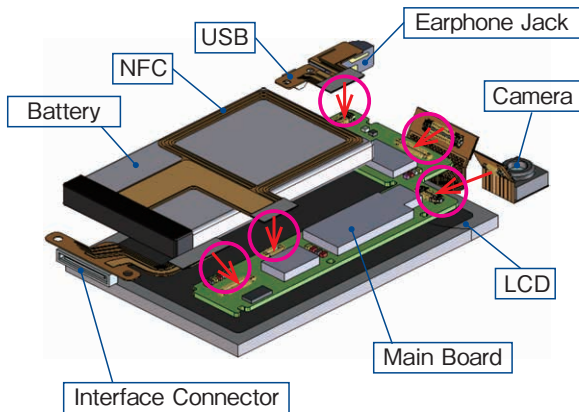

Product Specifications

Rated Current	Signal Contact : 0.3A Max. (The total current capacity of all pins is 10A Max.) Power Contact : 5A	Operating Temperature (Note 1)	-55 to +85°C
		Storage Temperature (Note 2)	-10 to +60°C
Rated Voltage	50V AC/DC	Operating Humidity Range	20-80%
		Storage Humidity Range (Note 2)	40-70%

Note 1 : Includes temperature rise caused by current flow.

Note 2 : The term "storage" refers to products stored for long period of time prior to mounting and use.

Operating Temperature and Humidity Range covers non-conducting condition of installed connectors in storage, shipment or during transportation.

Items	Specifications	Conditions
Contact Resistance	Signal contact : 70mΩ Max. Power contact : 15mΩ Max.	Measured at 20mV AC, 1kHz, and 1mA
Insulation Resistance	1000MΩ Min.	Measured at 100V DC
Withstanding Voltage	No flashover or dielectric breakdown	150V AC for 1 min.
Mating Durability	Contact resistance : Signal contact 100mΩ Max., Power contact: 30mΩ Max.	10 cycles
Vibration	No electrical discontinuity for more than 1 μs.	Frequency : 10 to 55Hz ; half amplitude of 0.75mm, 10 cycles in each of 3 axis directions for 5 minutes/cycle
Shock Resistance	No electrical discontinuity of 1 μs or more.	Acceleration : 450m/s ² , duration : 11ms, 3-axis half-sine wave in both directions, 3 cycles for each
Humidity Resistance	Contact resistance : Signal contact 70mΩ Max., Power contact 15mΩ Max. Insulation resistance : 100MΩ Min.	96 hours at a temperature of 40 ± 2°C and a humidity range from 90 to 95%
Temperature Cycle	Contact resistance : Signal contact 70mΩ Max., Power contact 15mΩ Max. Insulation resistance : 100MΩ Min.	-55 ± 3°C : 30 minutes → +85 ± 2°C : 30 minutes, 5 cycles
Solder Heat Resistance	No dissolution or resin melting that will affect performance.	Reflow : Recommended temperature profile ; Hand solder : Solder iron temperature of 350°C for 3 seconds Max.

Materials / Finish

Product	Part	Materials	Finish	UL Standard
Plug Receptacle	Insulator	LCP	Black	UL94V-0
	Signal Contact	Copper Alloy	Gold Plated	-
	Power Contact	Copper Alloy	Gold Plated	-

Product Number Structure

Refer to the chart below when determining the product specifications from the product number. Please select from the product numbers listed in this catalog when placing orders.

■ Plug/Receptacle

BM28 B 0.6 - # DS / 2 - 0.35 V (##)

① ② ③ ④ ⑤ ⑥ ⑦ ⑧

① Series Name	BM28	⑤ Number of Power Contacts	2
② Stacking Height	0.6mm	⑥ Contact Pitch	0.35mm
③ Number of Signal Contacts	6, 10, 16, 18, 20, 24, 30, 34, 36, 40, 44, 46, 50, 58, 60	⑦ Termination Type	V : Straight SMT
④ Connector Type	DP : Plug DS : Receptacle	⑧ Gold Plated Specification and Packaging	(51) : Gold Plate Thickness 0.05 μ m Embossed Tape Packaging (20,000pcs per reel) (53) : Gold Plate Thickness 0.05 μ m Embossed Tape Packaging (1,000pcs per reel)

Plug

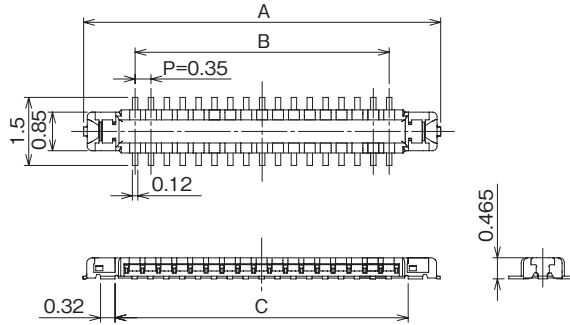
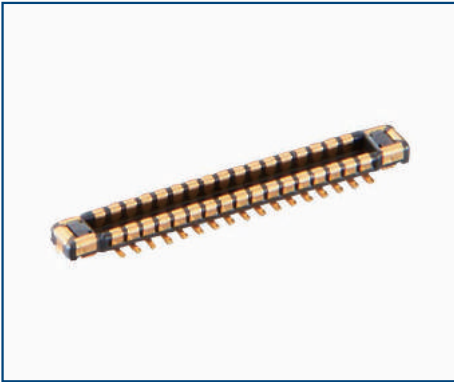

Recommended PCB Layout

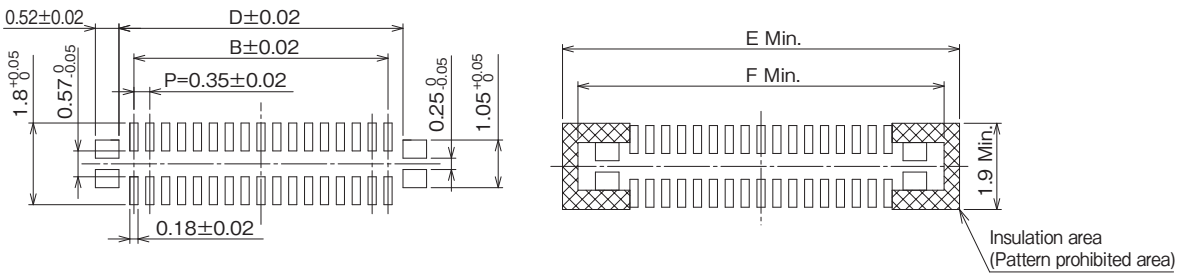

Recommended Metal Mask Dimensions (Mask Thickness : 0.08mm)

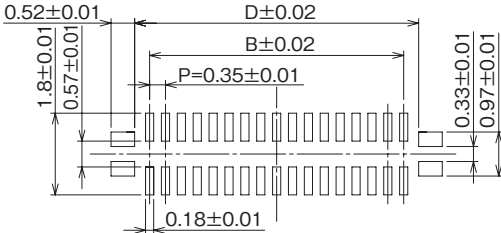

Unit : mm

Part No.	HRS No.	No. of Pos.	A	B	C	D	E	F	Purchase Unit (#) : (51)	Purchase Unit (#) : (53)
BM28B0.6-6DP/2-0.35V(##)	CL0673-5047-0-##	6	2.97	0.70	1.56	1.36	3.85	3.17	20,000pcs per reel	1,000pcs per reel
BM28B0.6-10DP/2-0.35V(##)	CL0673-5043-0-##	10	3.67	1.40	2.26	2.06	4.55	3.87		
BM28B0.6-16DP/2-0.35V(##)	CL0673-5066-0-##	16	4.72	2.45	3.31	3.11	5.60	4.92		
BM28B0.6-18DP/2-0.35V(##)	CL0673-5093-0-##	18	5.07	2.80	3.66	3.46	5.95	5.27		
BM28B0.6-20DP/2-0.35V(##)	CL0673-5039-0-##	20	5.42	3.15	4.01	3.81	6.30	5.62		
BM28B0.6-24DP/2-0.35V(##)	CL0673-5024-0-##	24	6.12	3.85	4.71	4.51	7.00	6.32		
BM28B0.6-30DP/2-0.35V(##)	CL0673-5020-0-##	30	7.17	4.90	5.76	5.56	8.05	7.37		
BM28B0.6-34DP/2-0.35V(##)	CL0673-5064-0-##	34	7.87	5.60	6.46	6.26	8.75	8.07		
BM28B0.6-36DP/2-0.35V(##)	CL0673-5026-0-##	36	8.22	5.95	6.81	6.61	9.10	8.42		
BM28B0.6-40DP/2-0.35V(##)	CL0673-5018-0-##	40	8.92	6.65	7.51	7.31	9.80	9.12		
BM28B0.6-44DP/2-0.35V(##)	CL0673-5049-0-##	44	9.62	7.35	8.21	8.01	10.50	9.82		
BM28B0.6-46DP/2-0.35V(##)	CL0673-5097-0-##	46	9.97	7.70	8.56	8.36	10.85	10.17		
BM28B0.6-50DP/2-0.35V(##)	CL0480-0397-0-##	50	10.67	8.40	9.26	9.06	11.55	10.87		
BM28B0.6-58DP/2-0.35V(##)	CL0480-0378-0-##	58	12.07	9.80	10.66	10.46	12.95	12.27		
BM28B0.6-60DP/2-0.35V(##)	CL0673-5037-0-##	60	12.42	10.15	11.01	10.81	13.30	12.62		

Note : This connector has no polarity.

Receptacle

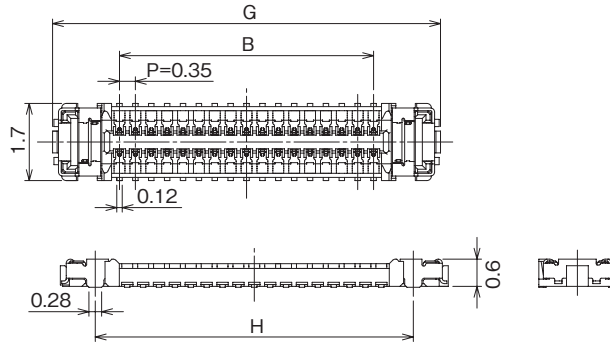
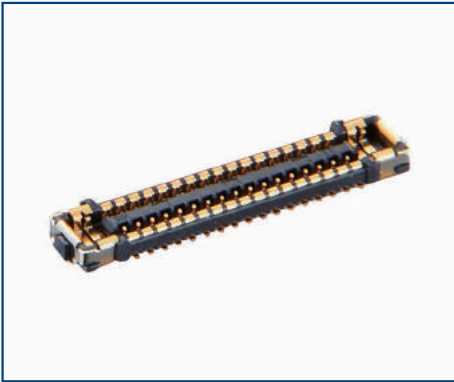

Recommended PCB Layout

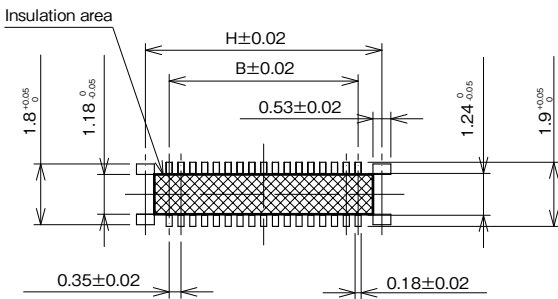

Recommended Metal Mask Dimensions (Mask Thickness : 0.08mm)

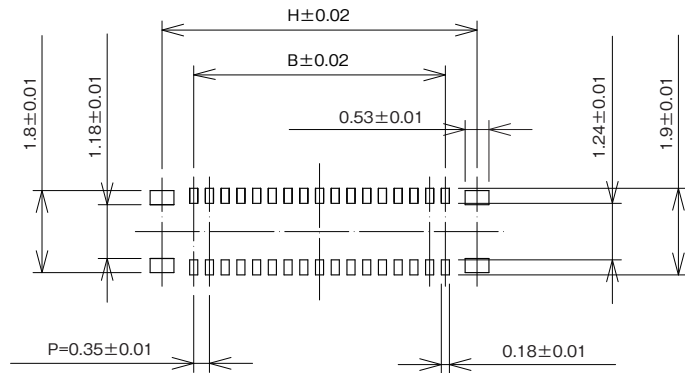

Unit : mm

Part No.	HRS No.	No. of Pos.	B	G	H	Purchase Unit (##) : (51)	Purchase Unit (##) : (53)
BM28B0.6-6DS/2-0.35V(##)	CL0673-5048-0-##	6	0.70	3.65	2.11	20,000pcs per reel	1,000pcs per reel
BM28B0.6-10DS/2-0.35V(##)	CL0673-5044-0-##	10	1.40	4.35	2.81		
BM28B0.6-16DS/2-0.35V(##)	CL0673-5067-0-##	16	2.45	5.40	3.86		
BM28B0.6-18DS/2-0.35V(##)	CL0673-5092-0-##	18	2.80	5.75	4.21		
BM28B0.6-20DS/2-0.35V(##)	CL0673-5040-0-##	20	3.15	6.10	4.56		
BM28B0.6-24DS/2-0.35V(##)	CL0673-5025-0-##	24	3.85	6.80	5.26		
BM28B0.6-30DS/2-0.35V(##)	CL0673-5021-0-##	30	4.90	7.85	6.31		
BM28B0.6-34DS/2-0.35V(##)	CL0673-5065-0-##	34	5.60	8.55	7.01		
BM28B0.6-36DS/2-0.35V(##)	CL0673-5027-0-##	36	5.95	8.90	7.36		
BM28B0.6-40DS/2-0.35V(##)	CL0673-5019-0-##	40	6.65	9.60	8.06		
BM28B0.6-44DS/2-0.35V(##)	CL0673-5050-0-##	44	7.35	10.30	8.76		
BM28B0.6-46DS/2-0.35V(##)	CL0673-5098-0-##	46	7.70	10.65	9.11		
BM28B0.6-50DS/2-0.35V(##)	CL0480-0396-0-##	50	8.40	11.35	9.81		
BM28B0.6-58DS/2-0.35V(##)	CL0480-0377-0-##	58	9.80	12.75	11.21		
BM28B0.6-60DS/2-0.35V(##)	CL0673-5038-0-##	60	10.15	13.10	11.56		

Note : This connector has no polarity.

Embossed Tape Dimensions (Complies with IEC 60286-3, JIS C 0806)

● Plug

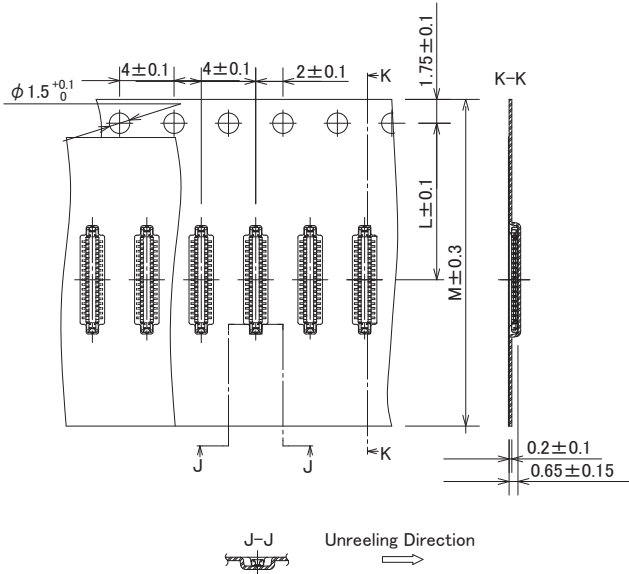

● Reel Dimensions

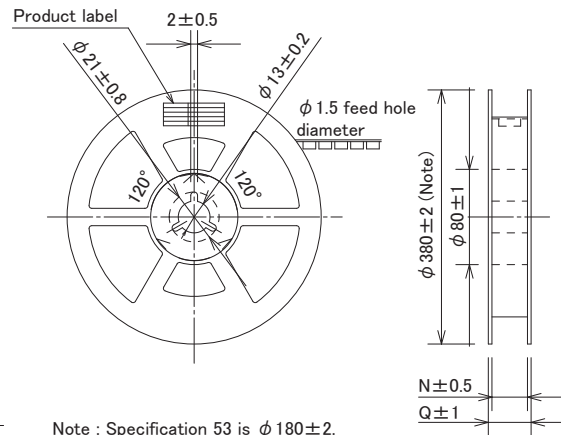

Unit : mm

Part No.	No. of Pos.	L	M	N	Q
BM28B0.6-6DP/2-0.35V(##)	6	5.5	12	13.5	17.5
BM28B0.6-10DP/2-0.35V(##)	10	5.5	12	13.5	17.5
BM28B0.6-16DP/2-0.35V(##)	16	7.5	16	17.5	21.5
BM28B0.6-18DP/2-0.35V(##)	18	7.5	16	17.5	21.5
BM28B0.6-20DP/2-0.35V(##)	20	7.5	16	17.5	21.5
BM28B0.6-24DP/2-0.35V(##)	24	7.5	16	17.5	21.5
BM28B0.6-30DP/2-0.35V(##)	30	7.5	16	17.5	21.5
BM28B0.6-34DP/2-0.35V(##)	34	11.5	24	25.4	29.4
BM28B0.6-36DP/2-0.35V(##)	36	11.5	24	25.4	29.4
BM28B0.6-40DP/2-0.35V(##)	40	11.5	24	25.4	29.4
BM28B0.6-44DP/2-0.35V(##)	44	11.5	24	25.4	29.4
BM28B0.6-46DP/2-0.35V(##)	46	11.5	24	25.4	29.4
BM28B0.6-50DP/2-0.35V(##)	50	11.5	24	25.4	29.4
BM28B0.6-58DP/2-0.35V(##)	58	11.5	24	25.4	29.4
BM28B0.6-60DP/2-0.35V(##)	60	11.5	24	25.4	29.4

● Receptacle

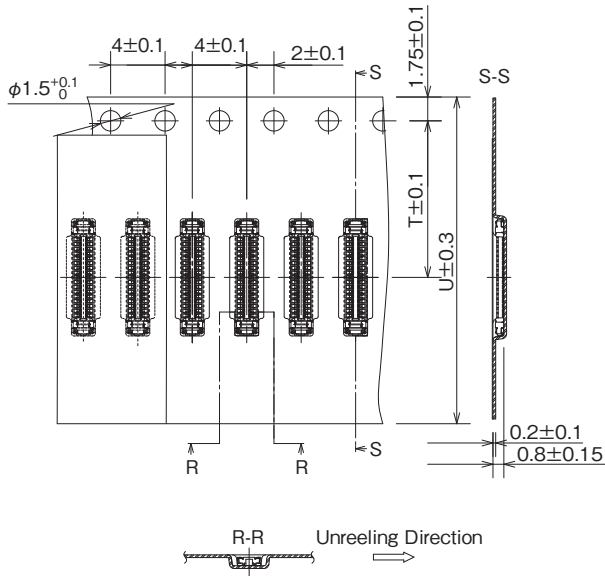

● Reel Dimensions

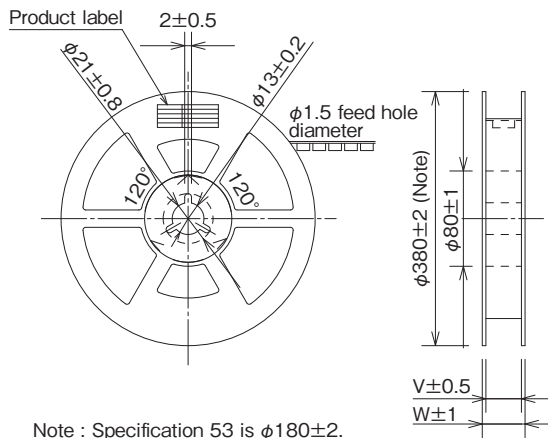

Unit : mm

Part No.	No. of Pos.	T	U	V	W
BM28B0.6-6DS/2-0.35V(##)	6	5.5	12	13.5	17.5
BM28B0.6-10DS/2-0.35V(##)	10	7.5	16	17.5	21.5
BM28B0.6-16DS/2-0.35V(##)	16	7.5	16	17.5	21.5
BM28B0.6-18DS/2-0.35V(##)	18	7.5	16	17.5	21.5
BM28B0.6-20DS/2-0.35V(##)	20	7.5	16	17.5	21.5
BM28B0.6-24DS/2-0.35V(##)	24	7.5	16	17.5	21.5
BM28B0.6-30DS/2-0.35V(##)	30	11.5	24	25.4	29.4
BM28B0.6-34DS/2-0.35V(##)	34	11.5	24	25.4	29.4
BM28B0.6-36DS/2-0.35V(##)	36	11.5	24	25.4	29.4
BM28B0.6-40DS/2-0.35V(##)	40	11.5	24	25.4	29.4
BM28B0.6-44DS/2-0.35V(##)	44	11.5	24	25.4	29.4
BM28B0.6-46DS/2-0.35V(##)	46	11.5	24	25.4	29.4
BM28B0.6-50DS/2-0.35V(##)	50	11.5	24	25.4	29.4
BM28B0.6-58DS/2-0.35V(##)	58	11.5	24	25.4	29.4
BM28B0.6-60DS/2-0.35V(##)	60	11.5	24	25.4	29.4

Usage Precautions

<p>Recommended Temperature Profile</p>	<p>[Conditions]</p> <ol style="list-style-type: none"> 1. Peak Temperature : Maximum of 250°C 2. Heating : 220°C min. for 60 sec. max. 3. Preheating : 150 to 180°C, 90 to 120 sec. 4. Number of Reflow Cycles : 2 cycles max. <p>Note : The temperature refers to the surface temperature of the board near the connector lead. Reflow mounting in a nitrogen environment is recommended.</p>
<p>Recommended Manual Soldering Conditions</p>	<p>Soldering Iron Temperature : 340 ± 10°C ; Soldering Time : within 3 seconds</p>
<p>Recommended Metal Mask Thickness and Open Area to PCB Pattern Area Ratio</p>	<p>Thickness : 0.08mm Aperture Ratio : Plug Side : (Signal Contact) 100%, (Power Contact) 80%, Receptacle Side : 100%</p>
<p>Board Warpage</p>	<p>Max. of 0.02mm at the center in reference to both ends of the connector</p>
<p>Cleaning</p>	<p>Cleaning is not recommended. If you clean this product, please evaluate its performance before using it. (Cleaning may impair the mating/unmating properties and lower resistance to environmental factors)</p>
<p>Precautions</p>	<ul style="list-style-type: none"> · Be careful when mating/unmating the connector when it is not mounted on the PCB as it may cause damage/deformation to contacts. · Avoid supporting the PCB only with the connectors. Support it by other means such as bolts, screws, posts, etc. · Excessive prying during unmating/mating may result in damage. · In the case of hand soldering, please do not apply any flux which could cause flux wicking. · This product may have slight color differences due to production lot variability, but this does not affect the performance. · Please refer to the following page for handling precautions when inserting and removing. · Because the product can disengage if dropped (or other impact), or by FPC routing, it is advised to secure the mated connectors to the board with housings and cushioning materials. · Do not use the connector in non-recommended conditions (i.e., rated current, rated voltage, PCB design and operating environment, etc.). Such usage could lead to material outgassing, ignition, or short-circuit, etc. Refer to the specifications and guidelines for board pattern dimensions, board cautions, and connector treatment. <p>Please contact Hirose if connector usage in conditions other than those described in the specifications and the guidelines is being considered.</p>

Connector Handling Precautions

Mating Method

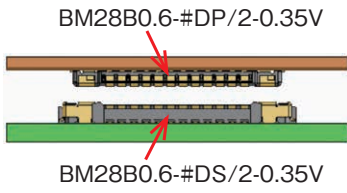

1) When aligning, look for the guide port without applying excessive force. If excessive force is applied, the housing may be damaged or shaved resulting in poor contact resistance, so please be careful.

Alignment method

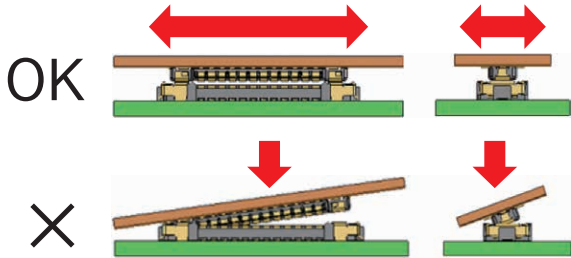

2) When fully aligned the connectors are parallel to each other with restricted longitudinal and lateral movement. Mate them parallel to each other.

Fully Aligned



Mated



Handling Precautions for Connector Removal

1) Pull out the connector parallel to each other.

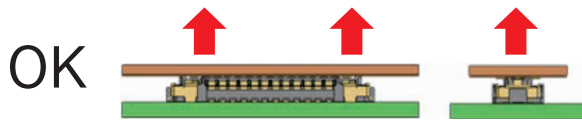

2) If the connector cannot be removed by pulling it out parallel to its mating partner, it can be removed by extracting the connector diagonally in the direction of the pitch as shown in the below figure.

However, there is a risk that the connector may break if the FPC is not rigid. Please confirm the FPC rigidity at the time of trial production.

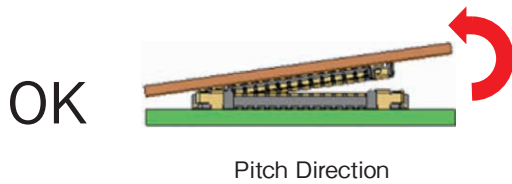

3) Do not remove the connector by pulling from the FPC corner as shown below. Pulling from the FPC corner may result in connector and contact damage.

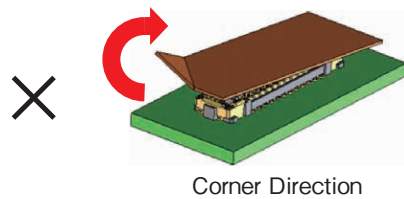

4) Please provide a reinforcing plate for the FPC.

Insufficient FPC rigidity may result in connector breakage as shown in the below figure. Please check the repeated mechanical operation of the FPC before use.

A reinforcing plate of 0.3mm or thicker made of glass epoxy material is recommended, or 0.2mm or thicker stainless steel is recommended.

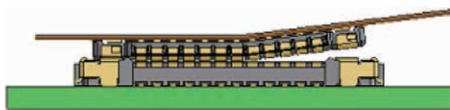

While Taking into Consideration

Specifications mentioned in this catalog are reference values.

When considering to order or use this product, please confirm the Drawing and Product Specifications sheets.

Use an appropriate cable when using the connector in combination with cables.

If considering usage of a non-specified cable, please contact your sales representative.



If assembly process is done by jigs & tools which are not identified by Hirose, assurance will not be given.

If considering usage for below mentioned applications, please contact your sales representative.

In cases where the application will demand a high level of reliability, such as automotive, medical instruments, public infrastructure, aerospace/ defense etc. Hirose must review before assurance of reliability can be given.

Looking for pricing, stock, or lifecycle information?

Click below to explore more details on WIN SOURCE:

-  [View BM28B0.6-50DS/2-0.35V\(51\) on WIN SOURCE](#)
-  [Hirose Electric Co Ltd Information](#)

Optimize Your Supply Chain with WIN SOURCE Solutions

-  Global Sourcing Solution
-  Obsolete Management
-  Cost Control Management
-  Shortage Management
-  Alternative Solution
-  Excess Inventory Management