



# THE DATASHEET OF BAV20WS-TP



# BAV19WS THRU BAV21WS

**250mW  
Small Signal  
Diodes  
120 to 250 Volts**

## Features

- Halogen free available upon request by adding suffix "-HF"
- Silicon Epitaxial Planar Diodes
- For General Purpose
- This diode is also available in other case.
- Lead Free Finish/RoHS Compliant("P" Suffix designates RoHS Compliant. See ordering information)

## Mechanical Data

- Epoxy meets UL 94 V-0 flammability rating
- Moisture Sensitivity Level 1
- Marking code: BAV19WS=A8  
 BAV20WS=T2  
 BAV21WS=T3

## Maximum Ratings

Symbol	Parameters	Rating	Unit	
$V_R$	Continuous Reverse Voltage	BAV19WS BAV20WS BAV21WS	100 150 200	V
	Repetitive Peak Reverse Voltage	BAV19WS BAV20WS BAV21WS	120 200 250	
	Non-Repetitive Peak Forward Surge Current @ $t=1\mu s$ @ $t=1s$	2.5 0.5	A	
$I_{FM}$	Forward Continuous Current (Note1)	400	mA	
$I_O$	Average Rectified Out put Current (Note1)	200	mA	
$I_{FRM}$	Repetitive Peak Forward Current at $f>50Hz$ , $T_{amb}=25^{\circ}C^{(1)}$	625	mA	
$P_{tot}$	Power Dissipation at $T_{amb}=25^{\circ}C^{(1)}$	250	mW	
$R_{thJA}$	Thermal Resistance Junction to Ambient Air	500	KW	
$T_J$	Operating Junction Temperature	-65 to +150	$^{\circ}C$	
$T_{STG}$	Storage Temperature	-65 to +150	$^{\circ}C$	

## Electrical Characteristics @ 25°C Unless Otherwise Specified

Symbol	Parameter	Min	Typ	Max	Units
$V_F$	Forward Voltage ( $I_F=100mA$ ) ( $I_F=200mA$ )	---	---	1.00	V
		---	---	1.25	
$I_R$	Leakage Current ( $V_R=100V$ ) ( $V_R=100V, T_J=100^{\circ}C$ ) ( $V_R=150V$ ) ( $V_R=150V, T_J=100^{\circ}C$ ) ( $V_R=200V$ ) ( $V_R=200V, T_J=100^{\circ}C$ )	BAV19WS	---	100	nA
		BAV19WS	---	15	uA
		BAV20WS	---	100	nA
		BAV20WS	---	15	uA
		BAV21WS	---	100	nA
		BAV21WS	---	15	uA
$C_{tot}$	Capacitance ( $V_R=0, f=1.0MHz$ )	---	1.5	---	pF
$t_{rr}$	Reverse Recovery Time ( $I_F=30mA, I_R=30mA$ ) ( $I_{rr}=3.0mA, R_L=100\Omega$ )	---	---	50	ns

Notes: 1. Valid provided that leads are kept at ambient temperature

## SOD-323

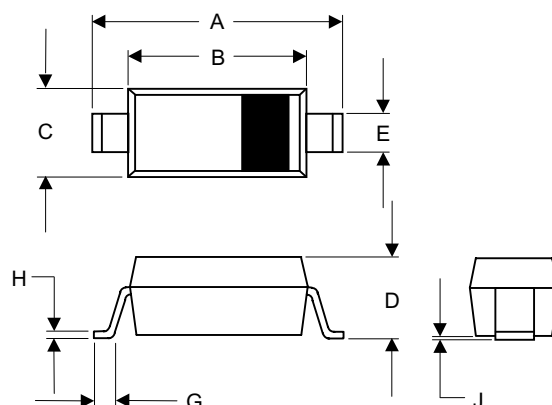

DIM	INCHES		MM		NOTE
	MIN	MAX	MIN	MAX	
A	.090	.107	2.30	2.70	
B	.063	.071	1.60	1.80	
C	.045	.053	1.15	1.35	
D	.031	.045	0.80	1.15	
E	.010	.016	0.25	0.40	
G	.004	.018	0.10	0.45	
H	.004	.010	0.10	0.25	
J	----	.006	----	0.15	

## SUGGESTED SOLDER PAD LAYOUT

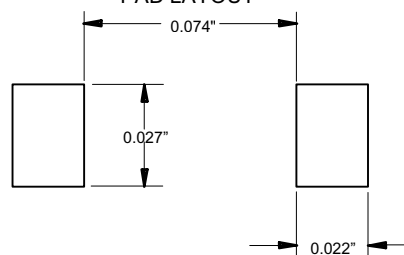

# BAV19WS thru BAV21WS

**Forward characteristics**

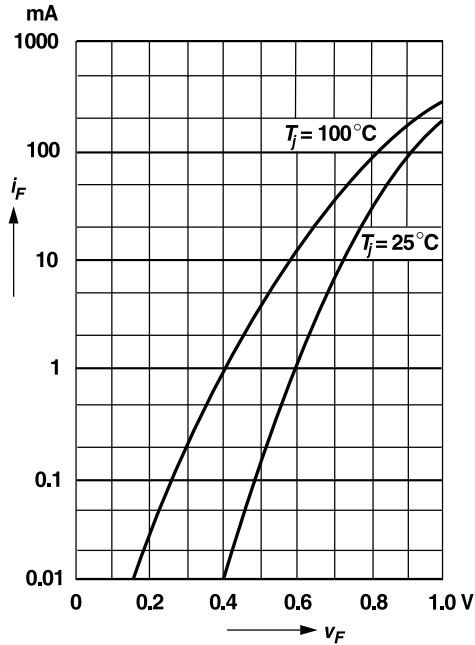

**Admissible forward current versus ambient temperature**

Valid provided that electrodes are kept at ambient temperature

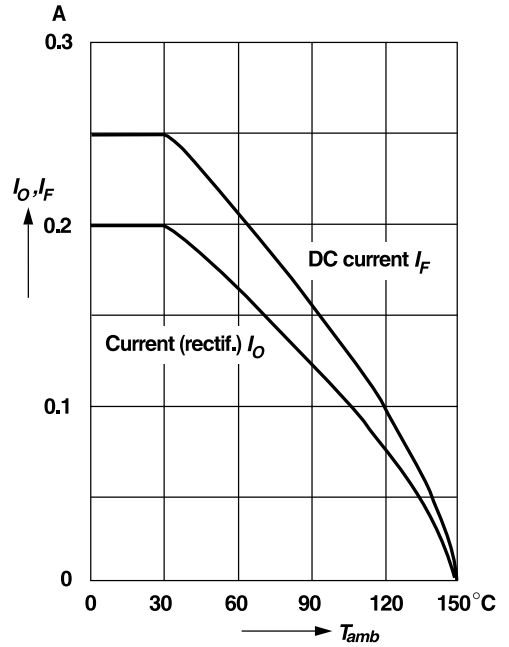

**Admissible power dissipation versus ambient temperature**

Valid provided that electrodes are kept at ambient temperature

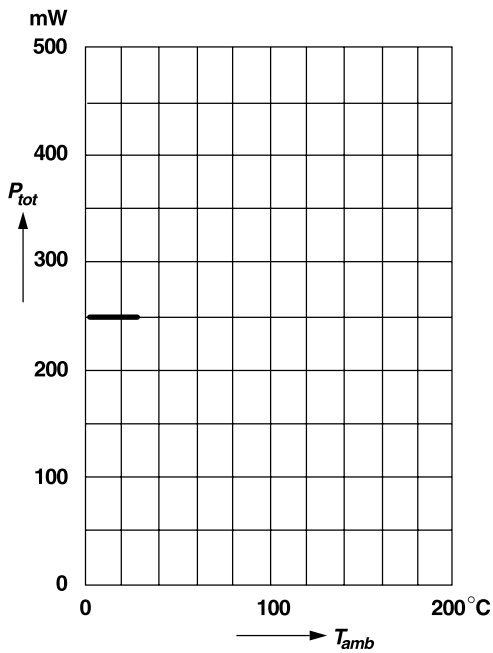

**Leakage current versus junction temperature**

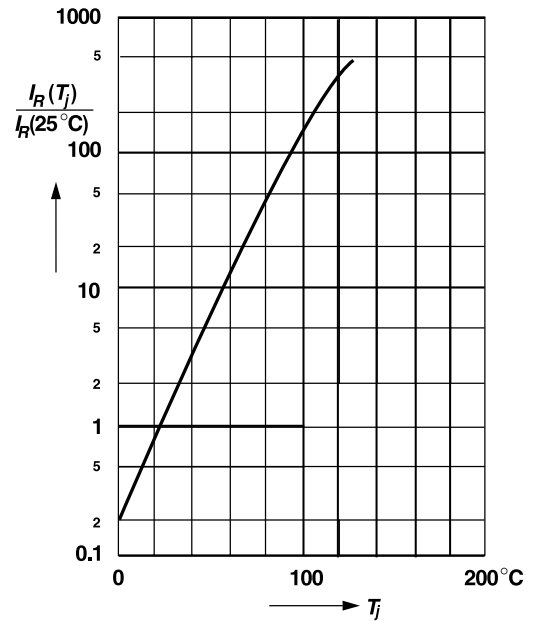

# BAV19WS thru BAV21WS

Dynamic forward resistance  
versus forward current

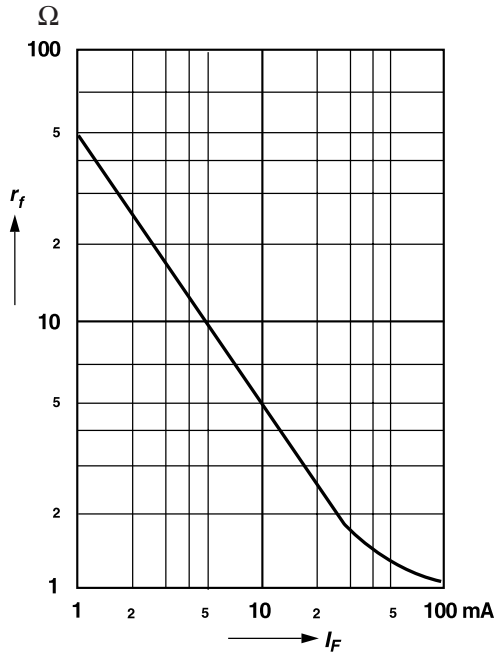

Capacitance  
versus reverse voltage

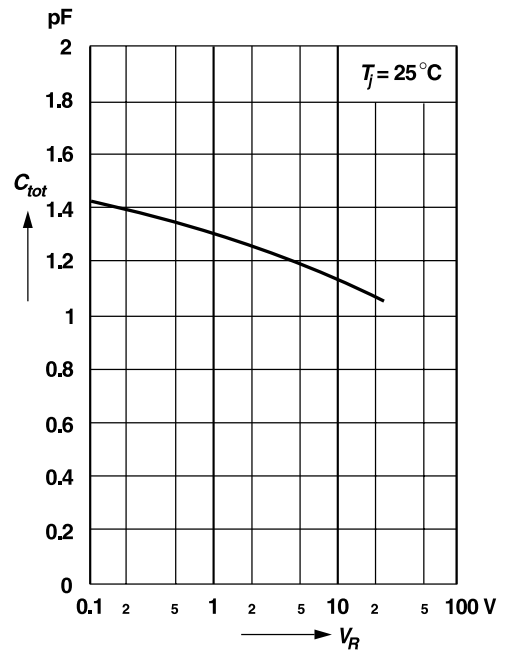



Micro Commercial Components

### Ordering Information :

Device	Packing
Part Number-TP	Tape&Reel: 3Kpcs/Reel

Note : Adding "-HF" suffix for halogen free, eg. Part Number-TP-HF

#### \*\*\*IMPORTANT NOTICE\*\*\*

**Micro Commercial Components Corp.** reserves the right to make changes without further notice to any product herein to make corrections, modifications , enhancements , improvements , or other changes . **Micro Commercial Components Corp .** does not assume any liability arising out of the application or use of any product described herein; neither does it convey any license under its patent rights ,nor the rights of others . The user of products in such applications shall assume all risks of such use and will agree to hold **Micro Commercial Components Corp .** and all the companies whose products are represented on our website, harmless against all damages.

#### \*\*\*LIFE SUPPORT\*\*\*

MCC's products are not authorized for use as critical components in life support devices or systems without the express written approval of Micro Commercial Components Corporation.

#### \*\*\*CUSTOMER AWARENESS\*\*\*

Counterfeiting of semiconductor parts is a growing problem in the industry. Micro Commercial Components (MCC) is taking strong measures to protect ourselves and our customers from the proliferation of counterfeit parts. MCC strongly encourages customers to purchase MCC parts either directly from MCC or from Authorized MCC Distributors who are listed by country on our web page cited below. Products customers buy either from MCC directly or from Authorized MCC Distributors are genuine parts, have full traceability, meet MCC's quality standards for handling and storage. **MCC will not provide any warranty coverage or other assistance for parts bought from Unauthorized Sources.** MCC is committed to combat this global problem and encourage our customers to do their part in stopping this practice by buying direct or from authorized distributors.

[www.mccsemi.com](http://www.mccsemi.com)

## Looking for pricing, stock, or lifecycle information?

Click below to explore more details on WIN SOURCE:

-  [View BAV20WS-TP on WIN SOURCE](#)
-  [Micro Commercial Co](#) Information

## Optimize Your Supply Chain with WIN SOURCE Solutions

-  Global Sourcing Solution
-  Obsolete Management
-  Cost Control Management
-  Shortage Management
-  Alternative Solution
-  Excess Inventory Management