



**THE DATASHEET OF
BM10NB(0.6)-40DS-0.4V(51)**



NEW

0.4mm Contact Pitch, Stacking Height 0.8mm Board-to-Board / Board-to-FPC Connectors

BM10 Series

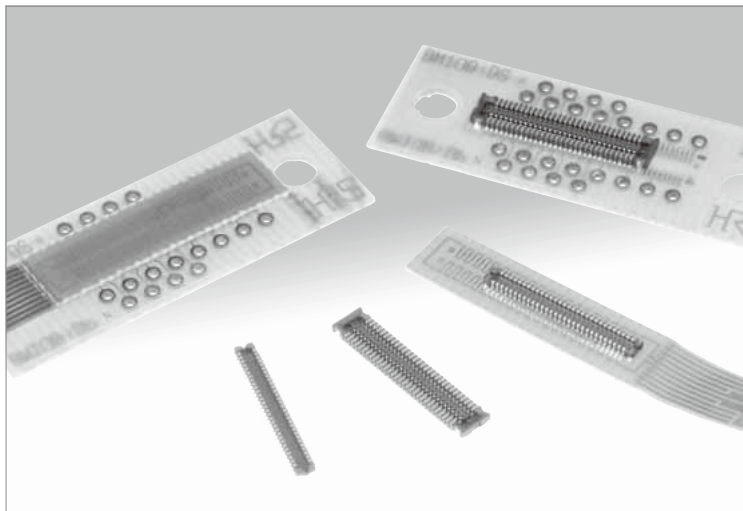

Decrease in the board-occupied area

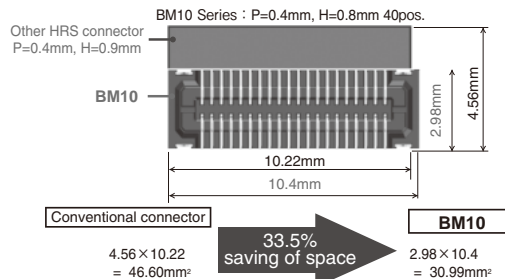

figure.1

High contact reliability



figure.2

Splatter protection

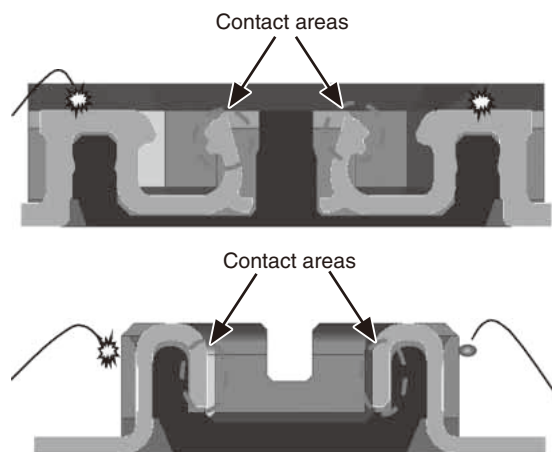

Contact areas are not exposed to the outside penetration of the flux or other physical particles.

figure.3

Features

1.Higher density of the board-mounted components

Extremely small board mounting pattern and low above the-board profile makes the connectors ideally suited for small device applications.

Globally unrivalled compact depth : when mated 2.98mm
Header 2.46mm

Length - world's smallest class : 10.4mm

2.Reliable electrical and mechanical connection

Despite its small mated height, unique contact configuration, with a 2-point contacts and effective mating length of 0.2mm(height 0.8mm), assures highly reliable connection while confirming a complete mating with a definite tactile feel.

3.Large self-alignment distance

The connectors will self-align within 0.3 mm.

4.Built-in shock absorbing feature

The protrusions and indents in the insulator bodies protect the connectors from failures when exposed to sudden impact.

5.Solder wicking prevention

Nickel barriers prevent un-intentional solder wicking.

6.Contamination protection

Insulator walls protect the contact areas against flux splatter or other physical particles contamination.

7.Conductive traces on the PCB can run under the connector

No exposed contacts on the bottom of the connector.

■ Specifications

Ratings	Current rating	0.3A	Operating temperature range	-35°C to +85°C (Note 1)	Storage temperature range	-10°C to +60°C (Note 2)
	Voltage rating	30V AC, DC	Operating humidity range	RH 20% to 80%	Storage humidity range	RH 40% to 70% (Note 2)

Item	Specification	Conditions
1. Insulation resistance	50MΩ min	100V DC
2. Withstanding voltage	No flashover or insulation breakdown	100V AC / 1minute
3. Contact resistance	100mΩ max.	20mV AC, 1kHz, 1mA
4. Vibration	No electrical discontinuity of 1μs or longer No damage or parts dislocation	Frequency : 10 to 55 Hz, 5min, single amplitude of 0.75 mm, 10cycles, for each directions.
5. Humidity	Contact resistance : 100mΩ max., Insulation resistance : 25MΩ min.	96hours at 40 ±2°C and humidity of 90 to 95% No damage or parts dislocation
6. Temperature cycle	Contact resistance : 100mΩ max., Insulation resistance : 50MΩ min. No damage or parts dislocation	-55°C → 5 to 35°C → 85°C → 5 to 35°C Time : 30min. → 10min. → 30min. → 10min. 5cycles
7. Durability	Contact resistance : 100mΩ max.	10cycles
8. Resistance to soldering heat	No deformation of components affecting performance	Reflow : At the recommended temperature profile Manual soldering : 350°C for 3 seconds

Note 1 : Includes temperature rise caused by current flow.

Note 2 : The term "storage" here refers to products stored for a long period prior to board mounting and use.

The operating temperature and humidity range covers the non-conducting condition of connectors after board mounting and the temporary storage conditions of transportation, etc.

Note 3 : Information contained in this catalog represents general requirements for this Series. Contact us for the drawings and specifications for a specific part number shown.

■ Material

Product	Part	Material	Finish	Remarks
Receptacle	Insulator	LCP	Color:Black	UL94V-0
Header	Contacts	Phosphor bronze	Gold plated	—

■ Ordering information

● Receptacles / Headers

BM 10 # (0.8) - * DS - 0.4 V ()**

① ② ③ ④ ⑤ ⑥ ⑦ ⑧ ⑨

① Series name : BM	⑥ Connector style DS : Double-row receptacle DP : Double-row header
② Series No. : 10	
③ Configuration B : With metal fittings NB : With metal fittings	⑦ Contact pitch : 0.4mm
	⑧ Termination type V...SMT vertical mount
④ Stacking Height : 0.8mm	⑨ Packaging (51) : Embossed tape packaging (8,000 pieces per reel) (53) : Embossed tape packaging (1,000 pieces per reel)
⑤ Number of contacts. 10 to 60	

■ H=0.8mm Receptacles (With metal fittings)

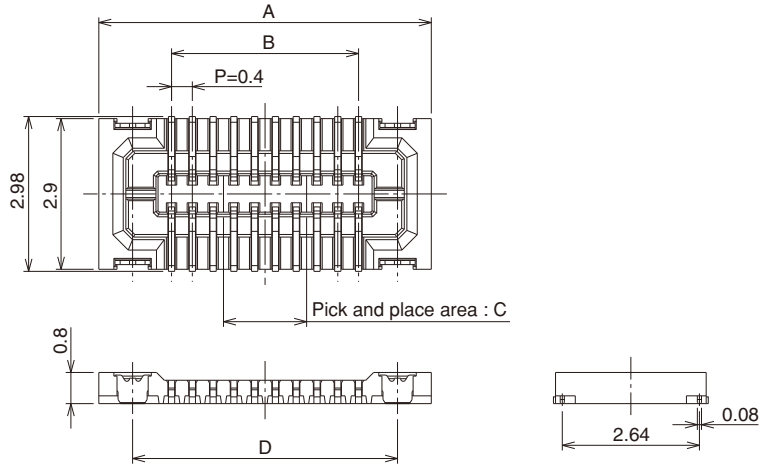
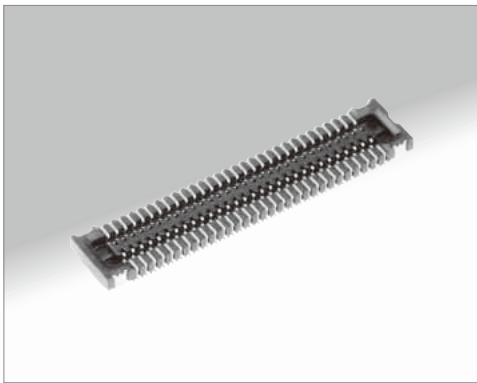

■ Recommended PCB mounting pattern

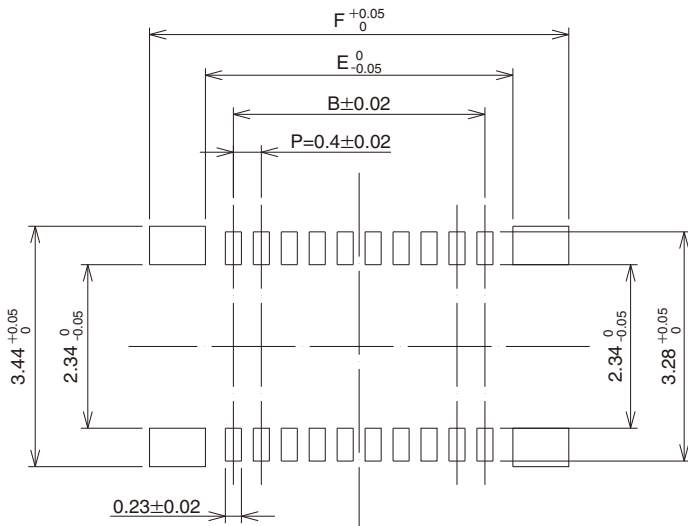

All dimensions : mm

Part Number	HRS No.	Number of Contacts	A	B	C	D	E	F
BM10NB(0.8)-10DS-0.4V(51)	684-6100-0 51	10	4.4	1.6	0.8	3.1	2.18	4.02
BM10NB(0.8)-16DS-0.4V(51)	684-6110-4 51	16	5.6	2.8	1.6	4.3	3.38	5.22
BM10NB(0.8)-20DS-0.4V(51)	684-6105-4 51	20	6.4	3.6	1.6	5.1	4.18	6.02
BM10NB(0.8)-24DS-0.4V(51)	684-6101-3 51	24	7.2	4.4	2	5.9	4.98	6.82
BM10NB(0.8)-30DS-0.4V(51)	684-6106-7 51	30	8.4	5.6	2	7.1	6.18	8.02
BM10NB(0.8)-34DS-0.4V(51)	684-6108-2 51	34	9.2	6.4	2.4	7.9	6.98	8.82
BM10NB(0.8)-40DS-0.4V(51)	684-6107-0 51	40	10.4	7.6	2.4	9.1	8.18	10.02
BM10NB(0.8)-44DS-0.4V(51)	684-6109-5 51	44	11.2	8.4	2.8	9.9	8.98	10.82
BM10NB(0.8)-50DS-0.4V(51)	684-6102-6 51	50	12.4	9.6	2.8	11.1	10.18	12.02
BM10NB(0.8)-60DS-0.4V(51)	684-6103-9 51	60	14.4	11.6	3.2	13.1	12.18	14.02

Note 1 : Order by number of reels.

Note 2 : This connector is NOT polarized.

■Headers (With metal fittings)

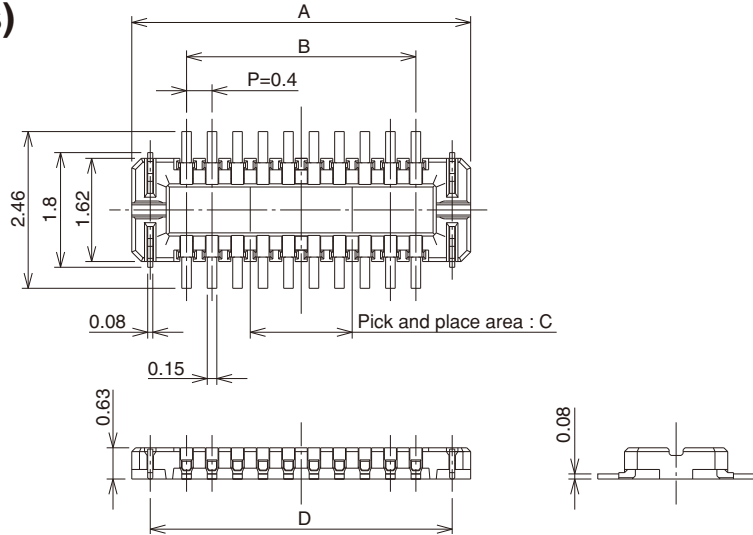
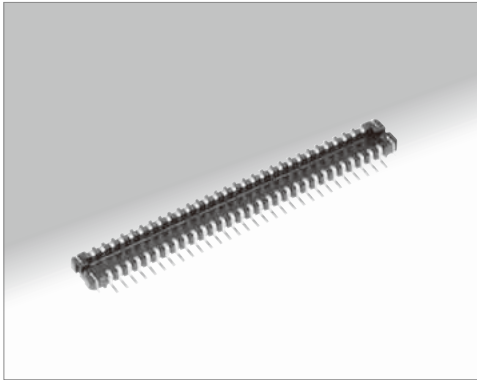

■Recommended metal mask dimensions

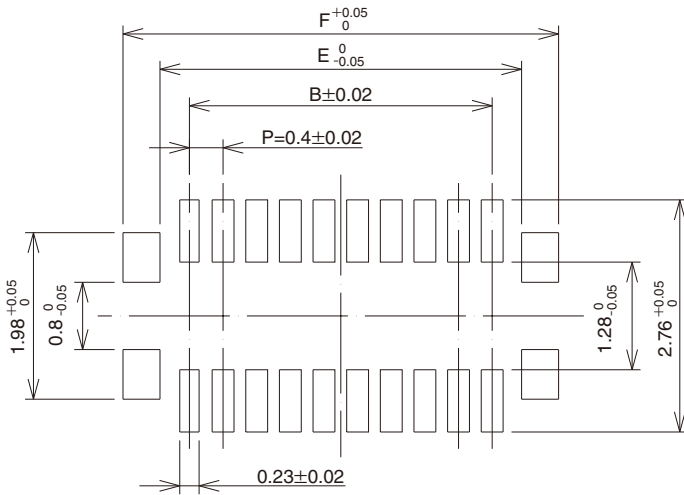

All dimensions : mm

Part Number	HRS No.	Number of Contacts	A	B	C	D	E	F
BM10B(0.8)-10DP-0.4V(51)	684-6007-5 51	10	3.32	1.6	0.8	2.74	2.3	3.18
BM10B(0.8)-16DP-0.4V(51)	684-6047-0 51	16	4.52	2.8	1.6	3.94	3.5	4.38
BM10B(0.8)-20DP-0.4V(51)	684-6009-0 51	20	5.32	3.6	1.6	4.74	4.3	5.18
BM10B(0.8)-24DP-0.4V(51)	684-6011-2 51	24	6.12	4.4	2	5.54	5.1	5.98
BM10B(0.8)-30DP-0.4V(51)	684-6013-8 51	30	7.32	5.6	2	6.74	6.3	7.18
BM10B(0.8)-34DP-0.4V(51)	684-6015-3 51	34	8.12	6.4	2.4	7.54	7.1	7.98
BM10B(0.8)-40DP-0.4V(51)	684-6003-4 51	40	9.32	7.6	2.4	8.74	8.3	9.18
BM10B(0.8)-44DP-0.4V(51)	684-6039-1 51	44	10.12	8.4	2.8	9.54	9.1	9.98
BM10B(0.8)-50DP-0.4V(51)	684-6017-9 51	50	11.32	9.6	2.8	10.74	10.3	11.18
BM10B(0.8)-60DP-0.4V(51)	684-6001-9 51	60	13.32	11.6	3.2	12.74	12.3	13.18

Note 1 : Order by number of reels.

Note 2 : This connector is NOT polarized.

■ Embossed Carrier Tape Dimensions

● Receptacle (24 and above positions)

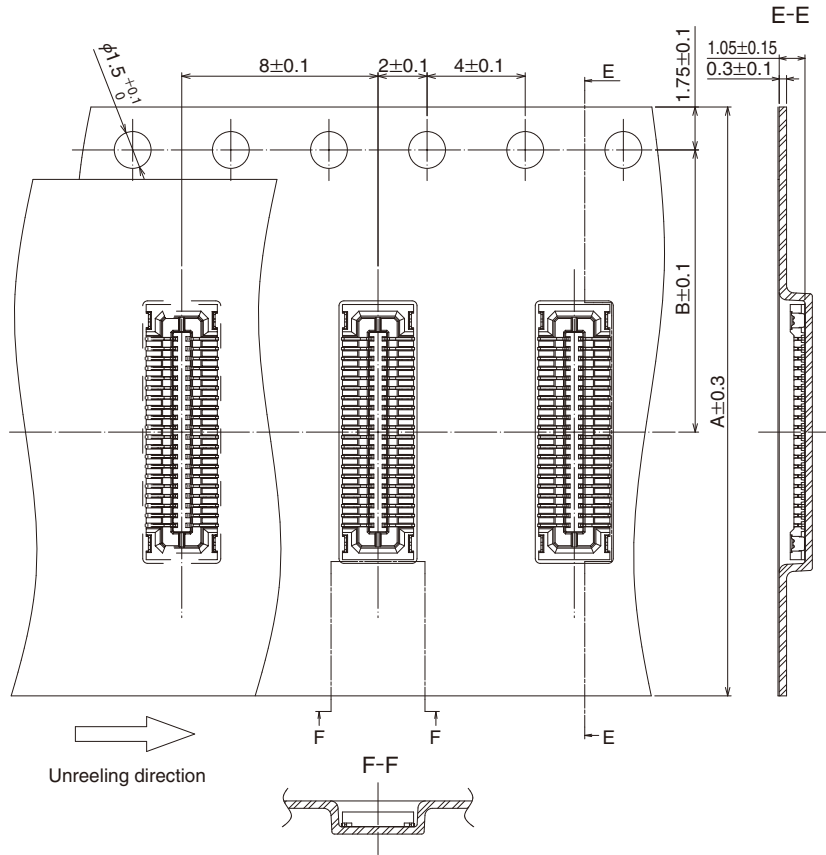

● Receptacle (less than 24 positions)

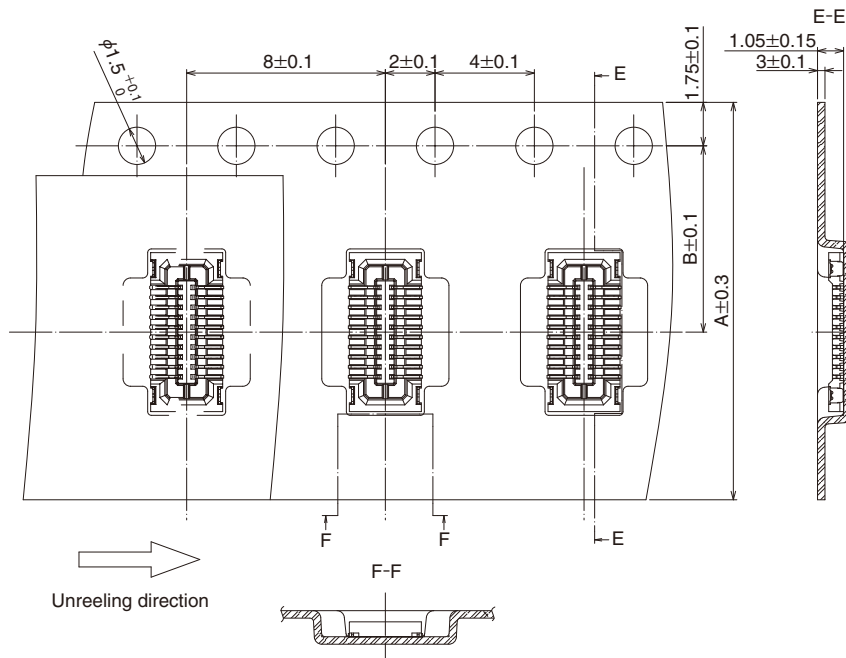

■Reel dimensions (Receptacles)

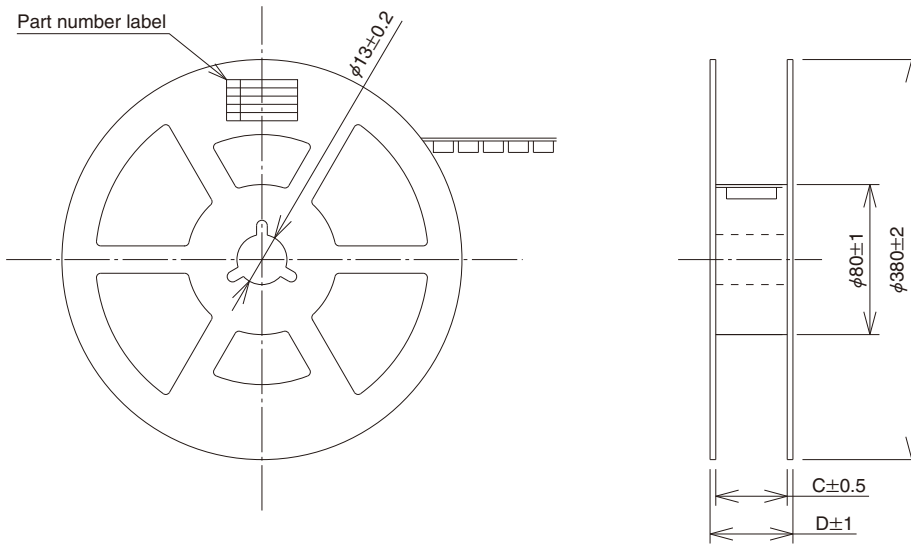

Unit : mm

Part Number	A	B	C	D
BM10#(0.8)-10DS-0.4V(51)	16	7.5	17.5	21.5
BM10#(0.8)-16DS-0.4V(51)	16	7.5	17.5	21.5
BM10#(0.8)-20DS-0.4V(51)	16	7.5	17.5	21.5
BM10#(0.8)-24DS-0.4V(51)	16	7.5	17.5	21.5
BM10#(0.8)-30DS-0.4V(51)	24	11.5	25.5	29.5
BM10#(0.8)-34DS-0.4V(51)	24	11.5	25.5	29.5
BM10#(0.8)-40DS-0.4V(51)	24	11.5	25.5	29.5
BM10#(0.8)-44DS-0.4V(51)	24	11.5	25.5	29.5
BM10#(0.8)-50DS-0.4V(51)	24	11.5	25.5	29.5
BM10#(0.8)-60DS-0.4V(51)	24	11.5	25.5	29.5

●Header

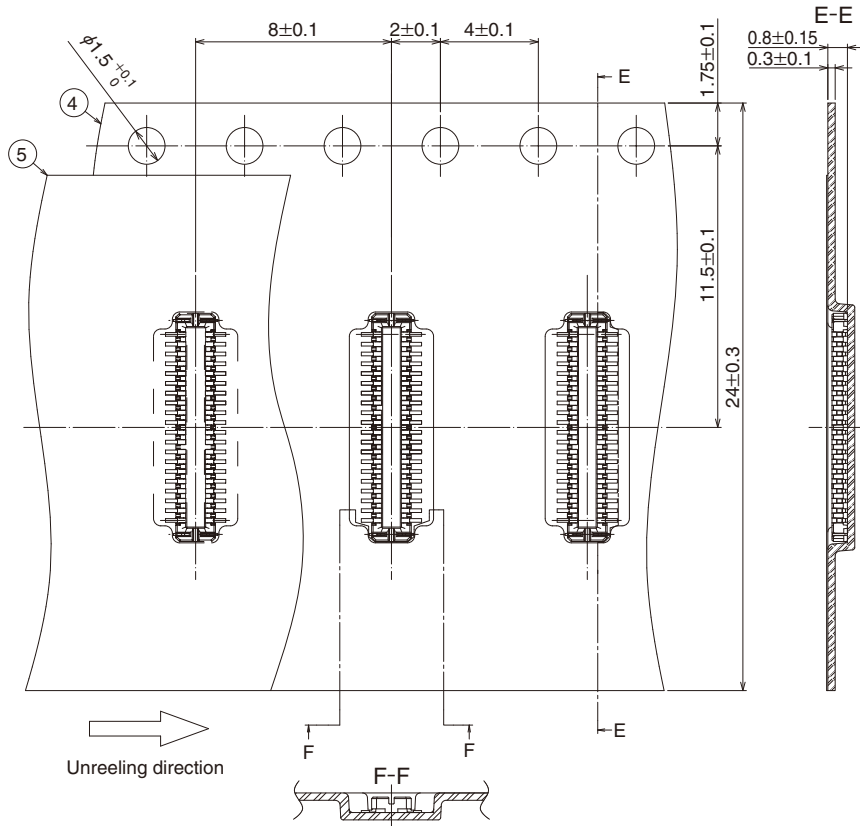

■Reel dimensions (Header)

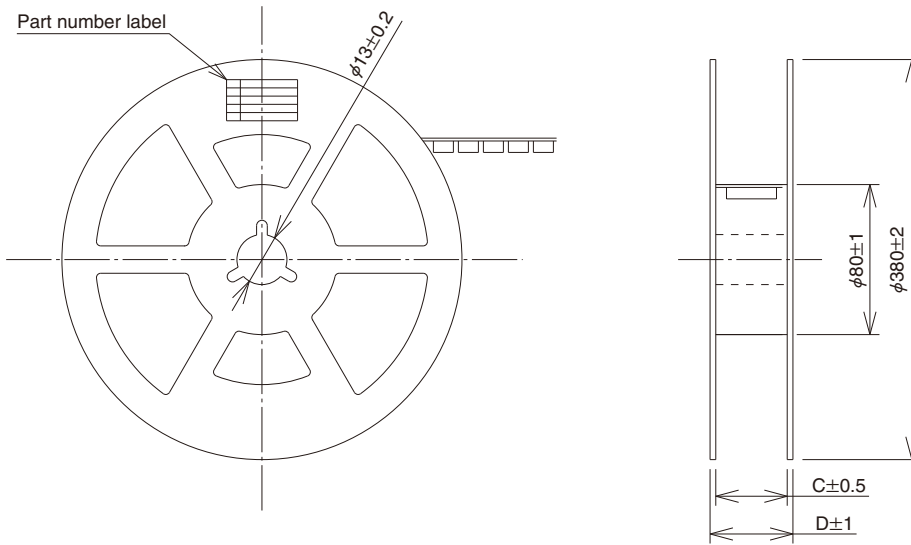

Unit : mm

Part Number	A	B	C	D
BM10#(0.8)-10DP-0.4V(51)	12	5.5	13.5	17.5
BM10#(0.8)-16DP-0.4V(51)	16	7.5	17.5	21.5
BM10#(0.8)-20DP-0.4V(51)	16	7.5	17.5	21.5
BM10#(0.8)-24DP-0.4V(51)	16	7.5	17.5	21.5
BM10#(0.8)-30DP-0.4V(51)	16	7.5	17.5	21.5
BM10#(0.8)-34DP-0.4V(51)	16	7.5	17.5	21.5
BM10#(0.8)-40DP-0.4V(51)	24	11.5	25.5	29.5
BM10#(0.8)-44DP-0.4V(51)	24	11.5	25.5	29.5
BM10#(0.8)-50DP-0.4V(51)	24	11.5	25.5	29.5
BM10#(0.8)-60DP-0.4V(51)	24	11.5	25.5	29.5

■ Usage Recommendations

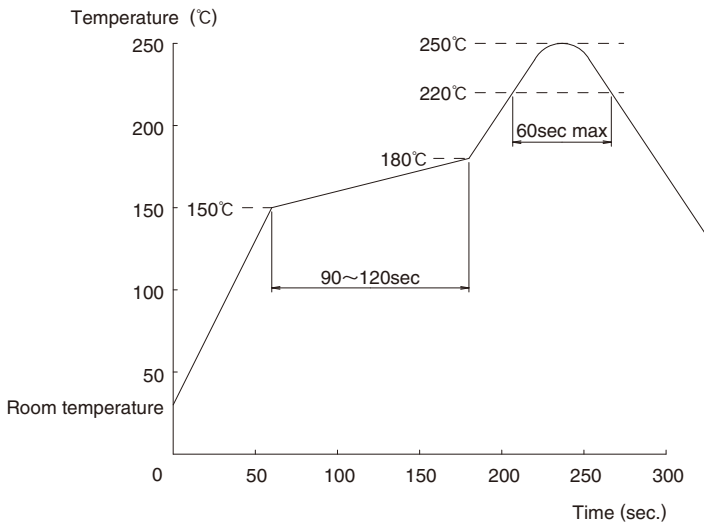
<p>1. Recommended temperature profile</p>	 <p>Note 1 : Up to 2 cycles of Reflow soldering are possible under the same conditions, provided that there is a return to normal temperature between the first and second cycle.</p> <p>Note 2 : The temperature profile indicates the board surface temperature at the point of contacts with the connector terminals.</p>
<p>2. Recommended manual soldering</p>	<p>Manual soldering : $340 \pm 10^\circ\text{C}$ for 3 seconds</p>
<p>3. Recommended screen thickness and open area ratio (Pattern area ratio)</p>	<p>Header, Receptacle : Thickness 0.12mm : Open area ratio 100%</p> <p>* When using nitrogen-reflow, 75% only at the header side.</p>
<p>4. Board warpage</p>	<p>Maximum of 0.02mm at the connector center, with both ends of the connector as reference points.</p>
<p>5. Cleaning conditions</p>	<p>Cleaning is not recommended.</p> <p>If you clean this product, please evaluate its performance before using it. (Cleaning may impair the mating/unmating properties and lower resistance to environmental factors.)</p>
<p>6. Precautions</p>	<ul style="list-style-type: none"> ■ Be careful when mating/unmating the connector when it is not mounted on the PCB as it may cause damage/deformation to contacts. ■ Avoid supporting the PCB only with the connectors. Support it by other means such as bolts, screws, posts, etc. ■ Excessive prying during unmating/mating may result in damage. ■ In the case of hand soldering, please do not apply any flux which could cause flux wicking. ■ This product may have slight color differences due to production lot variability, but this does not affect the performance. ■ Please refer to the following page for handling precautions when inserting and removing. ■ Because the product can disengage if dropped (or other impact), or by FPC routing, it is advised to secure the mated connectors to the board with housings and cushioning materials

■ Handling Precautions when Mating Connectors

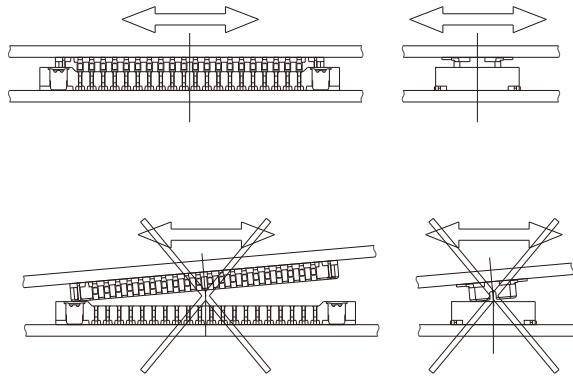
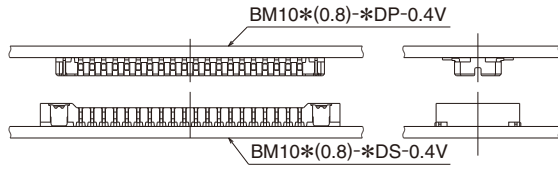

Keep the connectors parallel to each other when positioning. The connectors will self-align in horizontal directions.

Do not attempt to mate the connectors starting at one end or side.

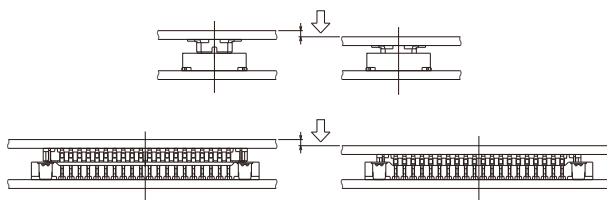

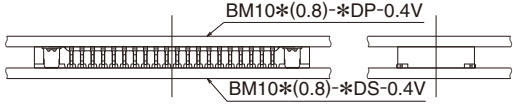
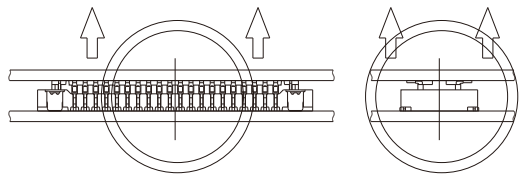
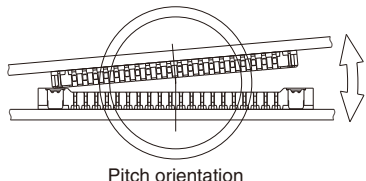
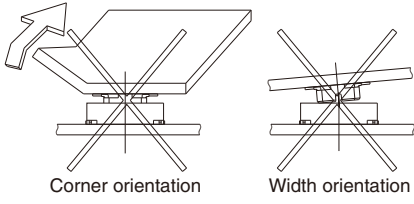
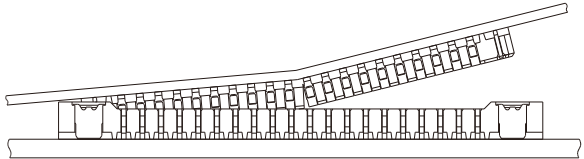

Press-down even until fully mated.

■ Handling Precautions When Un-mating Connectors

	<p>Fully mated</p>
	<p>Lift even, keeping both connectors parallel to each other</p>
 <p>Pitch orientation</p>	<p>When handling, circumstances may prevent the connectors from being kept parallel when un-mating. One end may be lifted as shown. However, to use this procedure the connector must be mounted on sufficiently rigid circuit board. Any deflection of the board during this operation may result in damage to the connector or solder joints.</p>
 <p>Corner orientation Width orientation</p>	<p>Do not attempt to start the un-mating of the connectors from one side or corner. Failure to exercise caution when un-mating the connectors mounted on the non-rigid FPC may also result in connector breakage. It is the responsibility of the user to perform verification of the repeated mating / un-mating cycles with the connectors mounted on the applicable FPC.</p>
	<p>When the rigidity of the FPC is low, there is a risk that the connector could break as illustrated in the diagram at left. Please use the connectors after performing a check of repeated operation with the FPC that the customer will be using. Evaluative results of FPC rigidity and various items are available. Please inquire.</p>

Looking for pricing, stock, or lifecycle information?

Click below to explore more details on WIN SOURCE:

-  [View BM10NB\(0.6\)-40DS-0.4V\(51\) on WIN SOURCE](#)
-  [Hirose Electric Co Ltd Information](#)

Optimize Your Supply Chain with WIN SOURCE Solutions

-  Global Sourcing Solution
-  Obsolete Management
-  Cost Control Management
-  Shortage Management
-  Alternative Solution
-  Excess Inventory Management