



THE DATASHEET OF BAV19WS-TP



BAV19WS THRU BAV21WS

**250mW
Small Signal
Diodes
120 to 250 Volts**

Features

- Halogen free available upon request by adding suffix "-HF"
- Silicon Epitaxial Planar Diodes
- For General Purpose
- This diode is also available in other case.
- Lead Free Finish/RoHS Compliant("P" Suffix designates RoHS Compliant. See ordering information)

Mechanical Data

- Epoxy meets UL 94 V-0 flammability rating
- Moisture Sensitivity Level 1
- Marking code: BAV19WS=A8
 BAV20WS=T2
 BAV21WS=T3

Maximum Ratings

Symbol	Parameters	Rating	Unit	
V_R	Continuous Reverse Voltage	BAV19WS BAV20WS BAV21WS	100 150 200	V
	Repetitive Peak Reverse Voltage	BAV19WS BAV20WS BAV21WS	120 200 250	
	Non-Repetitive Peak Forward Surge Current @ $t=1\mu s$ @ $t=1s$	2.5 0.5	A	
I_{FM}	Forward Continuous Current (Note1)	400	mA	
I_O	Average Rectified Out put Current (Note1)	200	mA	
I_{FRM}	Repetitive Peak Forward Current at $f>50Hz$, $T_{amb}=25^{\circ}C^{(1)}$	625	mA	
P_{tot}	Power Dissipation at $T_{amb}=25^{\circ}C^{(1)}$	250	mW	
R_{thJA}	Thermal Resistance Junction to Ambient Air	500	KW	
T_J	Operating Junction Temperature	-65 to +150	$^{\circ}C$	
T_{STG}	Storage Temperature	-65 to +150	$^{\circ}C$	

Electrical Characteristics @ 25°C Unless Otherwise Specified

Symbol	Parameter	Min	Typ	Max	Units
V_F	Forward Voltage ($I_F=100mA$) ($I_F=200mA$)	---	---	1.00	V
		---	---	1.25	
I_R	Leakage Current ($V_R=100V$) ($V_R=100V, T_J=100^{\circ}C$) ($V_R=150V$) ($V_R=150V, T_J=100^{\circ}C$) ($V_R=200V$) ($V_R=200V, T_J=100^{\circ}C$)	BAV19WS	---	100	nA
		BAV19WS	---	15	uA
		BAV20WS	---	100	nA
		BAV20WS	---	15	uA
		BAV21WS	---	100	nA
		BAV21WS	---	15	uA
C_{tot}	Capacitance ($V_R=0, f=1.0MHz$)	---	1.5	---	pF
t_{rr}	Reverse Recovery Time ($I_F=30mA, I_R=30mA$) ($I_{rr}=3.0mA, R_L=100\Omega$)	---	---	50	ns

Notes: 1. Valid provided that leads are kept at ambient temperature

SOD-323

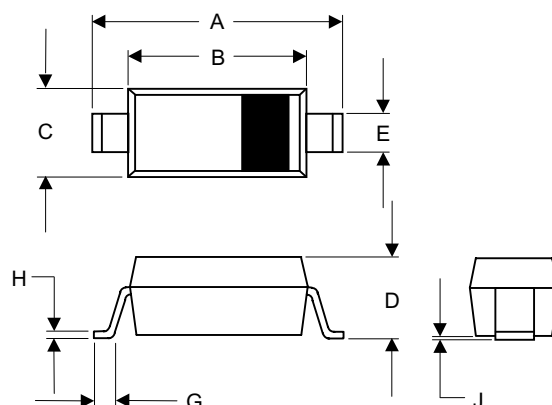

DIM	INCHES		MM		NOTE
	MIN	MAX	MIN	MAX	
A	.090	.107	2.30	2.70	
B	.063	.071	1.60	1.80	
C	.045	.053	1.15	1.35	
D	.031	.045	0.80	1.15	
E	.010	.016	0.25	0.40	
G	.004	.018	0.10	0.45	
H	.004	.010	0.10	0.25	
J	----	.006	----	0.15	

SUGGESTED SOLDER PAD LAYOUT

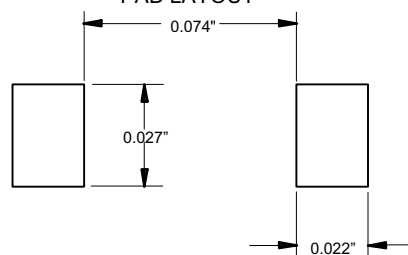

BAV19WS thru BAV21WS

Forward characteristics

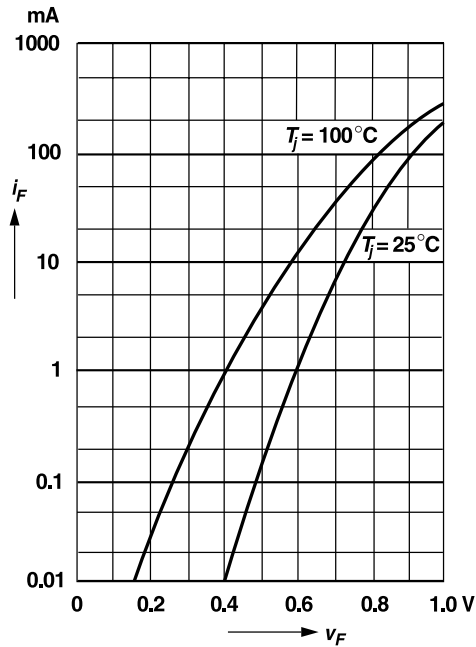

Admissible forward current versus ambient temperature

Valid provided that electrodes are kept at ambient temperature

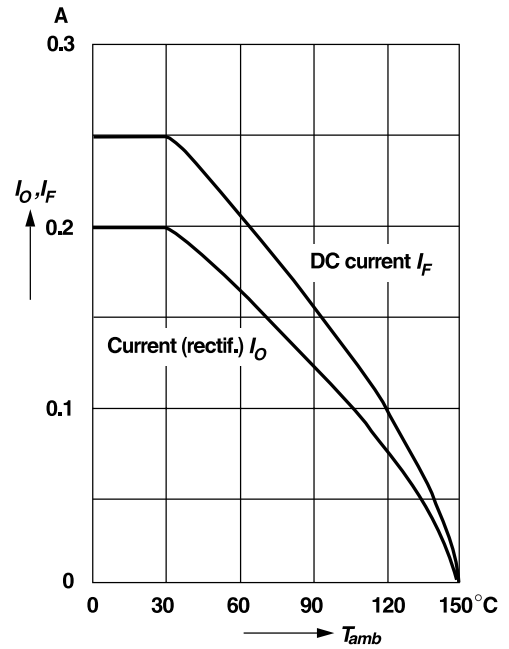

Admissible power dissipation versus ambient temperature

Valid provided that electrodes are kept at ambient temperature

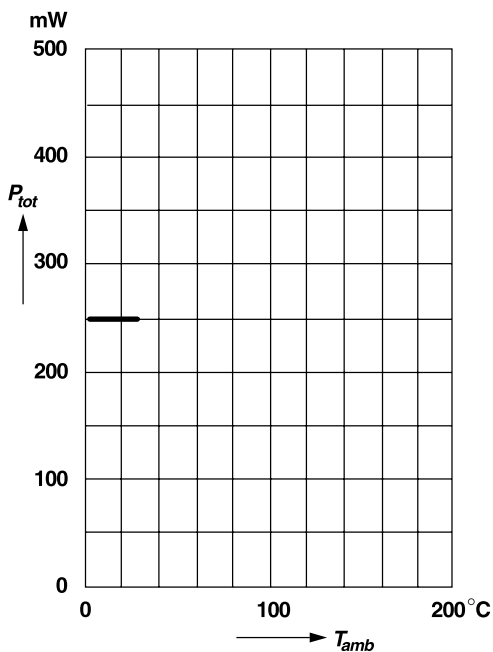

Leakage current versus junction temperature

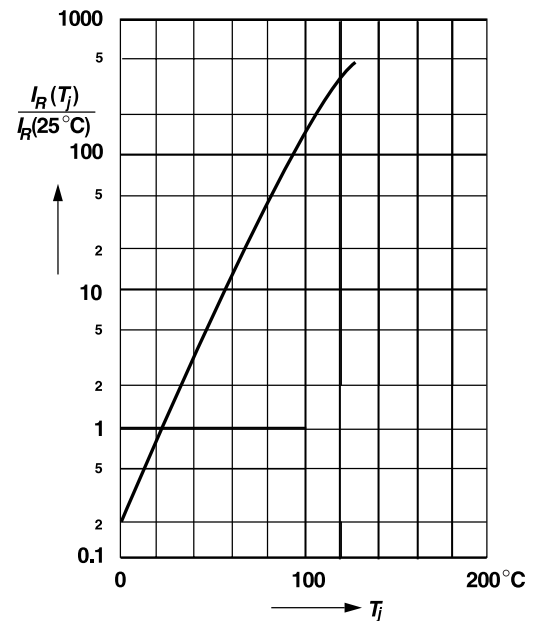

BAV19WS thru BAV21WS

Dynamic forward resistance
versus forward current

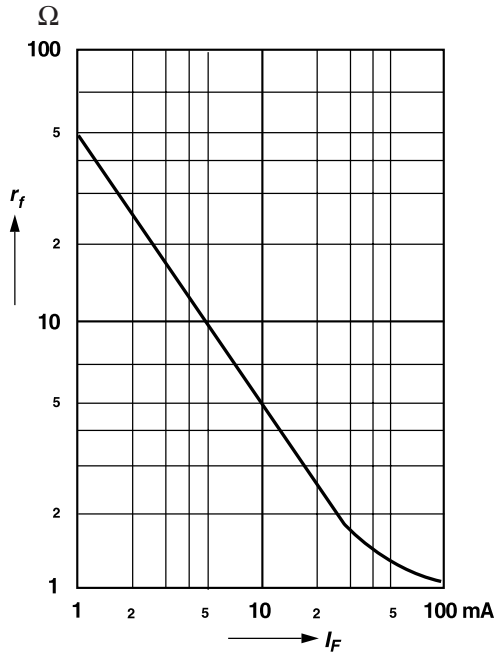

Capacitance
versus reverse voltage

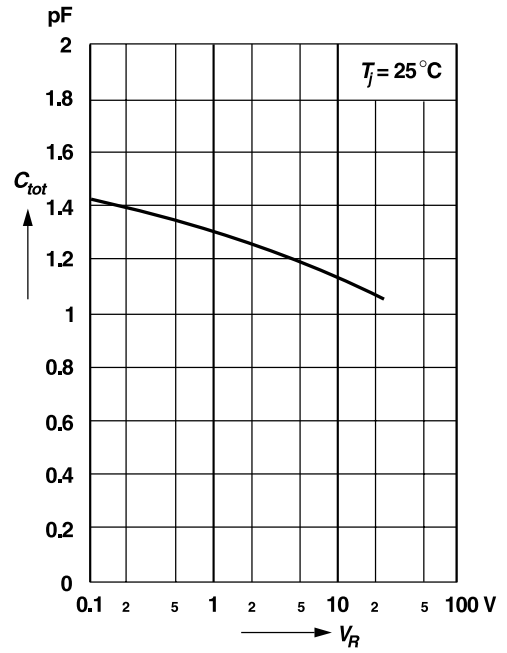



Micro Commercial Components

Ordering Information :

Device	Packing
Part Number-TP	Tape&Reel: 3Kpcs/Reel

Note : Adding "-HF" suffix for halogen free, eg. Part Number-TP-HF

IMPORTANT NOTICE

Micro Commercial Components Corp. reserves the right to make changes without further notice to any product herein to make corrections, modifications , enhancements , improvements , or other changes . **Micro Commercial Components Corp .** does not assume any liability arising out of the application or use of any product described herein; neither does it convey any license under its patent rights ,nor the rights of others . The user of products in such applications shall assume all risks of such use and will agree to hold **Micro Commercial Components Corp .** and all the companies whose products are represented on our website, harmless against all damages.

LIFE SUPPORT

MCC's products are not authorized for use as critical components in life support devices or systems without the express written approval of Micro Commercial Components Corporation.

CUSTOMER AWARENESS

Counterfeiting of semiconductor parts is a growing problem in the industry. Micro Commercial Components (MCC) is taking strong measures to protect ourselves and our customers from the proliferation of counterfeit parts. MCC strongly encourages customers to purchase MCC parts either directly from MCC or from Authorized MCC Distributors who are listed by country on our web page cited below. Products customers buy either from MCC directly or from Authorized MCC Distributors are genuine parts, have full traceability, meet MCC's quality standards for handling and storage. **MCC will not provide any warranty coverage or other assistance for parts bought from Unauthorized Sources.** MCC is committed to combat this global problem and encourage our customers to do their part in stopping this practice by buying direct or from authorized distributors.

www.mccsemi.com

Looking for pricing, stock, or lifecycle information?

Click below to explore more details on WIN SOURCE:

- ⊖ [View BAV19WS-TP on WIN SOURCE](#)
- ⊖ [Micro Commercial Co](#) Information

Optimize Your Supply Chain with WIN SOURCE Solutions

- ✓ Global Sourcing Solution
- ✓ Obsolete Management
- ✓ Cost Control Management
- ✓ Shortage Management
- ✓ Alternative Solution
- ✓ Excess Inventory Management