



**THE DATASHEET OF
BGT24MTR12E6327XUMA1**



BGT24MTR12

Silicon Germanium 24 GHz Transceiver MMIC

Data Sheet

Revision 3.2, 2014-07-15

Edition 2014-07-15

**Published by
Infineon Technologies AG
81726 Munich, Germany**

**© 2014 Infineon Technologies AG
All Rights Reserved.**

Legal Disclaimer

The information given in this document shall in no event be regarded as a guarantee of conditions or characteristics. With respect to any examples or hints given herein, any typical values stated herein and/or any information regarding the application of the device, Infineon Technologies hereby disclaims any and all warranties and liabilities of any kind, including without limitation, warranties of non-infringement of intellectual property rights of any third party.

Information

For further information on technology, delivery terms and conditions and prices, please contact the nearest Infineon Technologies Office (www.infineon.com).

Warnings

Due to technical requirements, components may contain dangerous substances. For information on the types in question, please contact the nearest Infineon Technologies Office.

Infineon Technologies components may be used in life-support devices or systems only with the express written approval of Infineon Technologies, if a failure of such components can reasonably be expected to cause the failure of that life-support device or system or to affect the safety or effectiveness of that device or system. Life support devices or systems are intended to be implanted in the human body or to support and/or maintain and sustain and/or protect human life. If they fail, it is reasonable to assume that the health of the user or other persons may be endangered.

BGT24MTR12 Silicon Germanium 24 GHz Transceiver MMIC

Revision History: 2014-07-15, Revision 3.2

Previous Revision: 2014-03-25, Revision 3.1

Page	Subjects (major changes since last revision)
24	update recommended footprint drawing (change of ground plains)

Trademarks of Infineon Technologies AG

AURIX™, C166™, CanPAK™, CIPOS™, CIPURSET™, EconoPACK™, CoolMOS™, CoolSET™, CORECONTROL™, CROSSAVE™, DAVE™, EasyPIM™, EconoBRIDGE™, EconoDUAL™, EconoPIM™, EiceDRIVER™, eupec™, FCOS™, HITFET™, HybridPACK™, I²RF™, ISOFACE™, IsoPACK™, MIPAQ™, ModSTACK™, my-d™, NovalithIC™, OptiMOS™, ORIGA™, PRIMARION™, PrimePACK™, PrimeSTACK™, PRO-SIL™, PROFET™, RASIC™, ReverSave™, SatRIC™, SIEGET™, SINDRION™, SIPMOS™, SmartLEWIS™, SOLID FLASH™, TEMPFET™, thinQ!™, TRENCHSTOP™, TriCore™.

Other Trademarks

Advance Design System™ (ADS) of Agilent Technologies, AMBA™, ARM™, MULTI-ICE™, KEIL™, PRIMECELL™, REALVIEW™, THUMB™, μVision™ of ARM Limited, UK. AUTOSAR™ is licensed by AUTOSAR development partnership. Bluetooth™ of Bluetooth SIG Inc. CAT-ig™ of DECT Forum. COLOSSUS™, FirstGPS™ of Trimble Navigation Ltd. EMV™ of EMVCo, LLC (Visa Holdings Inc.). EPCOS™ of Epcos AG. FLEXGO™ of Microsoft Corporation. FlexRay™ is licensed by FlexRay Consortium. HYPERTERMINAL™ of Hilgraeve Incorporated. IEC™ of Commission Electrotechnique Internationale. IrDA™ of Infrared Data Association Corporation. ISO™ of INTERNATIONAL ORGANIZATION FOR STANDARDIZATION. MATLAB™ of MathWorks, Inc. MAXIM™ of Maxim Integrated Products, Inc. MICROTREC™, NUCLEUS™ of Mentor Graphics Corporation. Mifare™ of NXP. MIPI™ of MIPI Alliance, Inc. MIPS™ of MIPS Technologies, Inc., USA. muRata™ of MURATA MANUFACTURING CO., MICROWAVE OFFICE™ (MWO) of Applied Wave Research Inc., OmniVision™ of OmniVision Technologies, Inc. Openwave™ Openwave Systems Inc. RED HAT™ Red Hat, Inc. RFMD™ RF Micro Devices, Inc. SIRIUS™ of Sirius Satellite Radio Inc. SOLARIS™ of Sun Microsystems, Inc. SPANSION™ of Spansion LLC Ltd. Symbian™ of Symbian Software Limited. TAIYO YUDEN™ of Taiyo Yuden Co. TEAKLITE™ of CEVA, Inc. TEKTRONIX™ of Tektronix Inc. TOKO™ of TOKO KABUSHIKI KAISHA TA. UNIX™ of X/Open Company Limited. VERILOG™, PALLADIUM™ of Cadence Design Systems, Inc. VLYNQ™ of Texas Instruments Incorporated. VXWORKS™, WIND RIVER™ of WIND RIVER SYSTEMS, INC. ZETEX™ of Diodes Zetex Limited.

Last Trademarks Update 2011-02-24

Table of Contents

	Table of Contents	4
	List of Figures	5
	List of Tables	6
1	Features	7
2	Electrical Characteristics	9
2.1	Absolute Maximum Ratings	9
2.2	Thermal Resistance	10
2.3	ESD Integrity	10
2.4	Measured RF Characteristics	11
2.4.1	Power Supply	11
2.4.2	TX Section	11
2.4.3	RX Section	13
2.5	Temperature Sensor	14
2.6	Power Detector	14
3	Application Circuit and Block Diagram	15
3.1	Application Circuit Schematic	15
3.2	Pin Description	17
3.3	SPI	18
3.4	Application Board	21
3.5	Equivalent Circuit Diagram of MMIC Interfaces	23
4	Physical Characteristics	24
4.1	Package Footprint	24
4.2	Reflow Profile	25
4.3	Package Dimensions	26

List of Figures

Figure 1	BGT24MTR12 Block Diagram	8
Figure 2	Application Circuit with Chip Outline (Top View)	15
Figure 3	Timing Diagram of the SPI	19
Figure 4	Cross-Section View of Application Board	21
Figure 5	Detail of Compensation Structure (valid for appl. board mat. Ro4350B, 0.254mm acc. to Fig. 5)	21
Figure 6	Application Board Layout	22
Figure 7	Equivalent Circuit Diagram of MMIC Interfaces	23
Figure 8	Recommended Footprint and Stencil Layout for the VQFN32-9 Package	24
Figure 9	Reflow Profile for BGT24MTR12 (VQFN32-9)	25
Figure 10	Package Outline (Top, Side and Bottom View)	26
Figure 11	Marking Layout VQFN32-9	26
Figure 12	Tape of VQFN32-9	27

List of Tables

Table 1	Absolute Maximum Ratings	9
Table 2	Thermal Resistance	10
Table 3	ESD Integrity	10
Table 4	Typical Characteristics $T_A = -40 \dots 105 \text{ }^\circ\text{C}$, SPI-Bit 4 = low	11
Table 5	Typical Characteristics $T_A = -40 \dots 105 \text{ }^\circ\text{C}$, $f = 24.0 \dots 24.25 \text{ GHz}$, SPI-Bit 4 = low	11
Table 6	Typical Characteristics $T_A = -40 \dots 105 \text{ }^\circ\text{C}$, $f = 24.0 \dots 24.25 \text{ GHz}$, SPI-Bit 4 = low	13
Table 7	Typical Characteristics Temperature Sensor $T_A = -40 \dots 105 \text{ }^\circ\text{C}$	14
Table 8	Typical Characteristics Power Detector $T_A = -40 \dots 105 \text{ }^\circ\text{C}$, $V_{CC} = 3.3 \text{ V}$	14
Table 9	Bill of Materials	16
Table 10	Pin Definition and Function	17
Table 11	SPI Block Data Bit Description	18
Table 12	SPI Timing and Logic Levels	19
Table 13	Truth Table AMUX	19

1 Features

- 24 GHz transceiver MMIC with one transmitter and two receiver units
- Fully integrated low phase noise VCO
- Switchable prescaler with 1.5 GHz and 23 kHz output
- On chip power and temperature sensors
- Gilbert based homodyne quadrature receiver
- Single ended RF input terminals
- Low noise figure NF_{SSB} : 12 dB
- High conversion gain: 26 dB
- High 1 dB input compression point: -12 dBm
- Single supply voltage 3.3 V
- Power consumption 690 mW in continuous operating mode
- 200 GHz bipolar SiGe:C technology b7hf200
- Fully ESD protected device
- VQFN-32-9 leadless plastic package incl. LTI feature
- Pb-free (RoHS compliant) package



Description

The BGT24MTR12 is a Silicon Germanium MMIC for signal generation and reception, operating from 24.0 to 24.25 GHz. It is based on a 24 GHz fundamental voltage controlled oscillator. A switchable frequency prescaler is included with output frequencies of 1.5 GHz and 23 kHz. The main RF output delivers typ. 11 dBm signal power to feed an antenna. A RC polyphase filter (PPF) is used for LO quadrature phase generation of the homodyne quadrature downconversion mixer. Output power sensors as well as a temperature sensor are implemented for monitoring purposes. The device is controlled via SPI and is manufactured in a 0.18 μ m SiGe:C technology offering a cutoff frequency of 200 GHz. The MMIC is packaged in a 32 pin leadless RoHS compliant VQFN package.

Product Name	Package	Chip	Marking
BGT24MTR12	VQFN32-9	T0825	BGT24MTR12

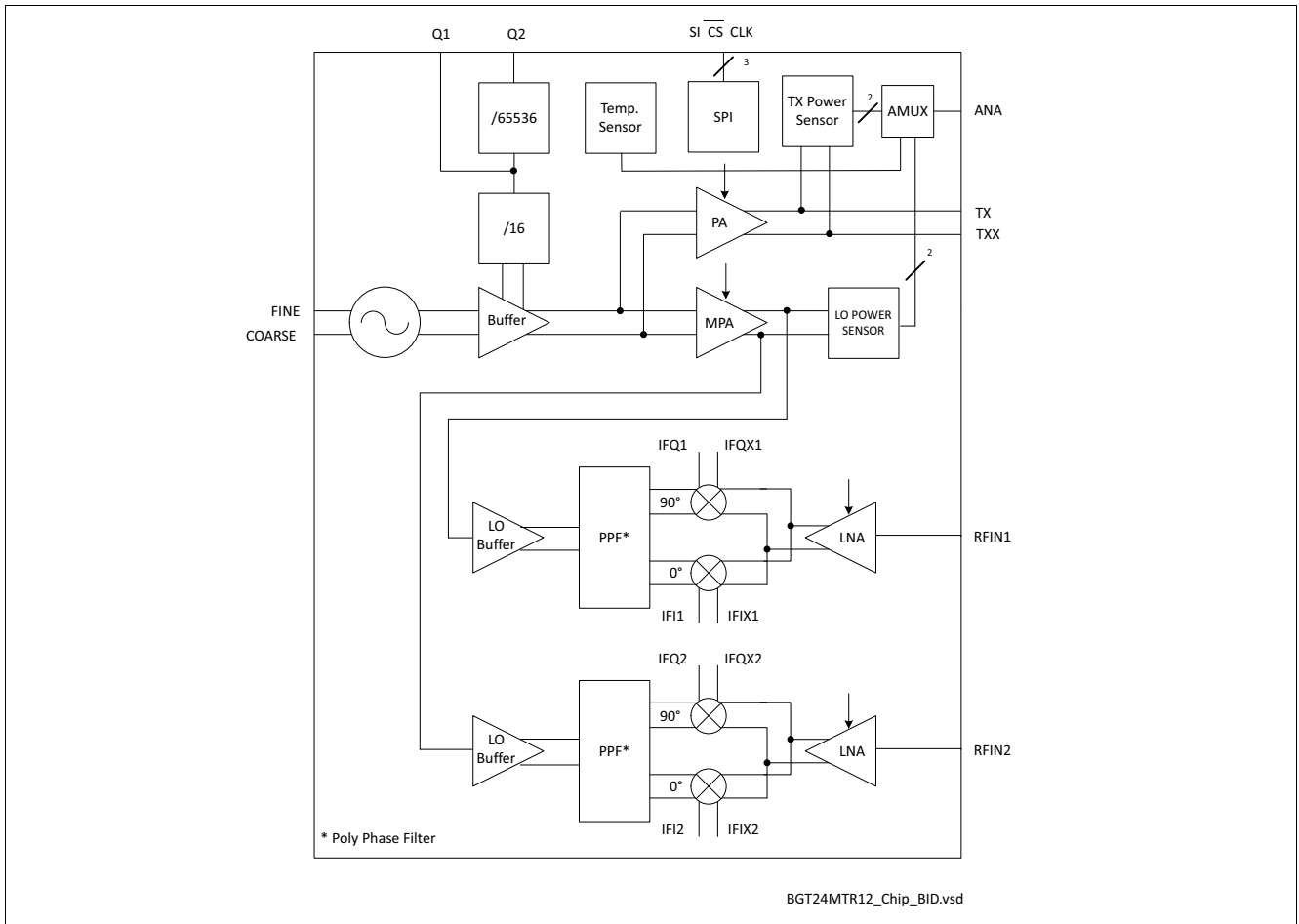

Figure 1 BGT24MTR12 Block Diagram

2 Electrical Characteristics

2.1 Absolute Maximum Ratings

$T_A = -40\text{ °C}$ to 105 °C ; all voltages with respect to ground, positive current flowing into pin (unless otherwise specified)¹⁾

Table 1 Absolute Maximum Ratings

Parameter	Symbol	Values			Unit	Note / Test Condition
		Min.	Typ.	Max.		
Supply voltage	V_{CC}	-0.3	–	3.6	V	–
DC voltage at RF Pins TX, TXX, RFIN1, RFIN2	VDC_{RF}	0	–	0	V	MMIC provides short circuit to GND for all RF pins
DC voltage at Pins IFI1/2, IFIX1/2, IFQ1/2, IFQX1/2	VDC_{IF}	0	–	Vcc	V	–
DC current into Pins IFI1/2, IFIX1/2, IFQ1/2, IFQX1/2	I_{IF}	-8.5	–	3.5	mA	max. values indicate current due to short circuit to GND and Vcc respectively
DC voltage at Pin ANA	VDC_{ANA}	-0.3	–	3.6	V	–
DC current into Pin ANA (Sink)	$I_{ANA\ SINK}$	125	350	500	μ A	max. values indicate current due to short circuit to GND and Vcc respectively
DC current into Pin ANA (Source)	$I_{ANA\ SOURCE}$	-7	–	–	mA	–
DC voltage at Pin Q1	VDC_{Q1}	Vcc-0.3	–	Vcc	V	–
DC current into Pin Q1	I_{Q1}	-8	–	12	mA	–
DC voltage at Pin Q2	VDC_{Q2}	-0.3	–	3.6	V	–
DC current into Pin Q2 enabled	I_{Q2EN}	-3	–	3	mA	–
DC current into Pin Q2 disabled	I_{Q2DIS}	-10	–	10	μ A	–
DC voltage at SPI input Pins SI, CLK, CS	VDC_{SPIIN}	-0.3	–	3.6	V	–
DC current into SPI input Pins SI, CLK, CS	I_{SPIIN}	–	–	3	mA	–
RF input power into Pins RFIN1, RFIN2	P_{RF}	–	–	0	dBm	–
DC voltage at Pins Fine, Coarse	V_F, V_C	0	–	5	V	–
DC current into Pins FINE, COARSE	I_F, I_C	-1	–	0.11	mA	Positive currents if $V_{TUNE} > V_{CC}$

1) Not subject to production test, specified by design

Table 1 Absolute Maximum Ratings (cont'd)

Parameter	Symbol	Values			Unit	Note / Test Condition
		Min.	Typ.	Max.		
Total power dissipation	P_{DISS}	–	–	1050	mW	With BIST deactivated
Junction temperature	T_J	-40	–	150	°C	–
Ambient temperature range	T_A	-40	–	105	°C	T_A = temperature at package soldering point
Storage temperature range	T_{STG}	-40	–	150	°C	–

Attention: Stresses exceeding the max. values listed here may cause permanent damage to the device. Exposure to absolute maximum rating conditions for extended periods may affect device reliability. Maximum ratings are absolute ratings; exceeding only one of these values may cause irreversible damage to the integrated circuit.

2.2 Thermal Resistance

Table 2 Thermal Resistance

Parameter	Symbol	Values			Unit	Note / Test Condition
		Min.	Typ.	Max.		
Junction - soldering point ¹⁾	R_{thJS}	–	–	40	K/W	–

1) For calculation of R_{thJS} please refer to application note thermal resistance

2.3 ESD Integrity

Table 3 ESD Integrity

Parameter	Symbol	Values			Unit	Note / Test Condition
		Min.	Typ.	Max.		
ESD robustness, HBM ¹⁾	$V_{ESD-HBM}$	-1	–	1	kV	All pins
ESD robustness, CDM ²⁾	$V_{ESD-CDM}$	-500	–	500	V	All pins

- 1) According to ANSI/ESDA/JEDEC JS-001 (R = 1.5kΩ, C = 100pF) for Electrostatic Discharge Sensitivity Testing, Human Body Model (HBM)-Component Level
- 2) According to JEDEC JESD22-C101 Field-Induced Charged Device Model (CDM), Test Method for Electrostatic-Discharge-Withstand Thresholds of Microelectronic Components

2.4 Measured RF Characteristics

2.4.1 Power Supply

Table 4 Typical Characteristics $T_A = -40 \dots 105 \text{ }^\circ\text{C}$, SPI-Bit 4 = low

Parameter	Symbol	Values			Unit	Note / Test Condition
		Min.	Typ.	Max.		
Supply voltage	V_{CC}	3.135	3.3	3.465	V	–
Supply current	I_{CC}	150	210	270	mA	Max. TX output power, all prescalers are activated, LO and TX output buffer in high mode

2.4.2 TX Section

Table 5 Typical Characteristics $T_A = -40 \dots 105 \text{ }^\circ\text{C}$, $f = 24.0 \dots 24.25 \text{ GHz}$, SPI-Bit 4 = low¹⁾

Parameter	Symbol	Values			Unit	Note / Test Condition
		Min.	Typ.	Max.		
VCO frequency range	f_{VCO}	24.0	–	24.25	GHz	–
VCO fine tuning voltage ²⁾	V_F	0.5 ³⁾	–	3.1	V	–
VCO coarse tuning voltage ²⁾	V_C	0.5 ³⁾	–	3.1	V	–
VCO tuning slope FINE	$\Delta f / \Delta V_F$	–	–	1500	MHz/V	–
VCO tuning slope COARSE	$\Delta f / \Delta V_C$	–	–	3000	MHz/V	–
VCO temperature drift	$\Delta f / \Delta T$	-10	-6	0	MHz/K	Min @ $T = -40^\circ\text{C}$
VCO pushing	$\Delta f / \Delta V_{CC}$	-350	60	350	MHz/V	Absolute values
VCO phase noise	P_N	–	-85	-75	dBc/Hz	@ 100kHz offset, $V_F = V_C$
TX/TXX load impedance	Z_{TX} Z_{TXX}	–	20.8-j20.2 19.5-j11.7	–	Ω	Typical value at 24.125GHz and $VSWR \leq 2:1$
Max. TX output power	P_{TX}	6	11	15	dBm	–
TX output power adjustable range	a_{TX}	3	9	–	dB	Adjustable via SPI
TX output power in “off” mode ⁴⁾	P_{TXoff}	–	–	-30	dBm	Parameter based on IFX eval board design
Q1 Prescaler division ratio	D_{Q1}	–	2 ⁴⁾	–	–	–
Q1 Prescaler output power	P_{Q1}	-14	-9	-4	dBm	Q1 loaded with 50 Ohm (AC-coupled)
Q1 output impedance ⁴⁾	Z_{Q1}	–	50	–	Ω	–

Table 5 Typical Characteristics $T_A = -40 \dots 105 \text{ }^\circ\text{C}$, $f = 24.0 \dots 24.25 \text{ GHz}$, **SPI-Bit 4 = low¹⁾** (cont'd)

Parameter	Symbol	Values			Unit	Note / Test Condition
		Min.	Typ.	Max.		
Q2 Prescaler division ratio	D_{Q2}	–	2^{20}	–	–	–
Q2 Prescaler max. output voltage	$V_{\max Q2}$	2.4	–	–	V	Test condition: Q2 loaded with high impedance probe (1 MOhm, 13 pF)
Q2 Prescaler min. output voltage	$V_{\min Q2}$	–	–	0.8	V	Test condition: Q2 loaded with high impedance probe (1 MOhm, 13 pF)
Q2 Prescaler max. output source current	$I_{\max \text{source } Q2}$	1.2	–	–	mA	Test condition: Q2 loaded with 50 Ohm to Vcc
Q2 Prescaler max. output sink current	$I_{\max \text{sink } Q2}$	1.2	–	–	mA	Test condition: Q2 loaded with 50 Ohm to Vcc
Q2 Prescaler output resistance in disable mode	$R_{Q2,DIS}$	100	–	–	k Ω	–

- 1) Performance based on Application Circuit Figure 2 on Page 15, Cross Section of Application Board, Compensation Structures and Application Board Layout Figure 4 on Page 21ff and Footprint Figure 8 on Page 24
- 2) At tuning pins chipinternal pull-up of $60\text{k}\Omega \pm 20\%$ to VCC; max.- and min. temperature tuning voltage limits are chosen in a way that they can be linearly interpolated within operating temperature range
- 3) Min. limit @ $25^\circ\text{C} = 0.8\text{V}$; min. limit @ $105^\circ\text{C} = 1.15\text{V}$
- 4) Guaranteed by device design

2.4.3 RX Section

Table 6 Typical Characteristics $T_A = -40 \dots 105 \text{ }^\circ\text{C}$, $f = 24.0 \dots 24.25 \text{ GHz}$, SPI-Bit 4 = low¹⁾

Parameter	Symbol	Values			Unit	Note / Test Condition
		Min.	Typ.	Max.		
RFIN frequency range	f_{RFIN}	24.0	–	24.25	GHz	–
RFIN port impedance ²⁾	Z_{RFIN1} Z_{RFIN2}	–	15.9-j18.4 15.7-j18.9	–	Ω	Typical value at 24.125GHz and VSWR \leq 2:1
RFIN VSWR	VSWR	–	–	2:1	–	At source port of off chip compensation network as proposed
IF frequency range	f_{IF}	0	–	10	MHz	–
IF output impedance	Z_{IF}	850	1000	1150	Ω	–
Leakage LO to RFIN	$L_{\text{LO} \rightarrow \text{RFIN}}$	–	–	-30	dBm	LO Signal Power @ RFIN Port, Parameter based on IFX eval board design
Isolation RFIN1 to RFIN2	$I_{\text{RFIN1-RFIN2}}$	30	–	–	dB	Parameter based on IFX eval board design
Voltage conversion gain ³⁾	G_C	19	26	31	dB	$R_{\text{LOAD,IF}} > 10 \text{ k}\Omega$
LNA gain reduction	ΔG_{CLG}	3	5	8	dB	–
SSB noise figure	N_{SSB}	–	12	20	dB	Single sideband at $f_{\text{IF}} = 100 \text{ kHz}$
IF 1/f corner frequency	f_c	–	10	20	kHz	–
Input compression point	$IP_{1\text{dB}}$	-17	-12	–	dBm	–
Input 3rd order intercept point	$IIP3$	-8	-4	–	dBm	–
Quadrat. phase imbalance	ε_p	-10	–	10	deg	–
Quadrat. amplitude imbalance	ε_A	-1	–	1	dB	–

1) Performance based on Application Circuit Figure 2 on Page 15, Cross Section of Application Board, Compensation Structures and Application Board Layout Figure 4 on Page 21ff and Footprint Figure 8 on Page 24

2) Guaranteed by device design

3) Lowest gain at high temperature, highest gain at low temperature

2.5 Temperature Sensor

Monitoring of the chip temperature is provided by the on-chip temperature sensor which delivers temperature-proportional voltage.

Table 7 Typical Characteristics Temperature Sensor $T_A = -40 .. 105 \text{ }^\circ\text{C}^{1)}$

Parameter	Symbol	Values			Unit	Note / Test Condition
		Min.	Typ.	Max.		
Temperature range	T_{TSENS}	-40	–	105	$^\circ\text{C}$	–
Output temperature voltage	$V_{\text{OUT,TEMP}}$	–	1.50	–	V	@ 25 $^\circ\text{C}$
Sensitivity	S_{TSENS}	–	4.5	–	mV/K	–
Overall accuracy error	Err_{TSENS}	–	–	± 15	K	–

1) all voltages with respect to ground, positive current flowing into pin (unless otherwise specified)

2.6 Power Detector

For RF power indication, peak voltage detectors are connected to the output of the TX power amplifier and to the LO medium power amplifier. To eliminate temperature and supply voltage variations, a reference output V_{REF} is available through the ANA output for the TX and LO power sensor. The compensated detector output voltage is given by the difference between V_{OUT} and V_{REF} for both power sensors respectively. This voltage is proportional to the RF voltage swing at the individual amplifier outputs, its characteristic is non-directional.

Table 8 Typical Characteristics Power Detector $T_A = -40 .. 105 \text{ }^\circ\text{C}$, $V_{\text{CC}} = 3.3 \text{ V}^{1)}$

Parameter	Symbol	Values			Unit	Note / Test Condition
		Min.	Typ.	Max.		
Power range	P_{PSENS}	-10	–	15	dBm	–
TX power sensor	$V_{\text{OUT,TX}}$ - $V_{\text{REF,TX}}$	–	550	–	mV	@ $P_{\text{TX}} = 11 \text{ dBm}$
LO power sensor	$V_{\text{OUT,LO}}$ - $V_{\text{REF,LO}}$	–	50	–	mV	@ typ. internal P_{LO}

1) all voltages with respect to ground, positive current flowing into pin (unless otherwise specified)

Table 9 Bill of Materials

Part Number	Part Type	Manufacturer	Size	Comment
C1 ... C4	Chip capacitor	Various	Various	–
R1 ... R2	Chip resistor	Various	0402	–

3.2 Pin Description

Table 10 Pin Definition and Function

Pin No.	Name	Function
1	VCC	Supply voltage
2	VEE	Ground
3	RFIN1	RF input downconverter 1
4	VEE	Ground
5	FINE	VCO fine tuning input
6	COARSE	VCO coarse tuning input
7	VEE	Ground
8	RFIN2	RF input downconverter 2
9	VEE	Ground
10	VCC	Supply voltage
11	VEE	Ground
12	IFQX2	Complementary quadrature phase IF output downconverter 2
13	IFQ2	Quadrature phase IF output downconverter 2
14	IFI2	In phase IF output downconverter 2
15	IFIX2	Complementary in phase IF output downconverter 2
16	TEST PIN	Test pin; DC coupled pin
17	TEST PIN	Test pin; DC coupled pin
18	\overline{CS}	Chip select input SPI (inverted)
19	CLK	Clock input SPI block
20	SI	Data input SPI block
21	VEE	Ground
22	TX	Transmit output
23	TXX	Complementary transmit output
24	VEE	Ground
25	ANA	Analog output
26	Q1	Prescaler output 1.5GHz
27	Q2	Prescaler output 23kHz
28	IFIX1	Complementary in phase IF output downconverter 1
29	IFI1	In phase IF output downconverter 1
30	IFQ1	Quadrature phase IF output downconverter 1
31	IFQX1	Complementary quadrature phase IF output downconverter 1
32	VEE	Ground

3.3 SPI

1.) Three signals control the serial peripheral interface of the BGT24MTR12:

SI (Data); CLK (Clock); \overline{CS} (Chip select)

2.) The data bits SI (MSB first) are read in the shift register with falling edge of the CLK signal.

Please make sure, that the data is present at least 10 ns before and at least 10 ns after the falling edge of the clock signal.

3.) The CLK and \overline{CS} signals are combined internally.

At least 20 ns before first rising edge of the first CLK signal \overline{CS} needs to be in "low" state.

While the Data is read, \overline{CS} has to remain in "low" state.

4.) When Data read in is finished, the shift register content will be written in the latch at the rising edge of the \overline{CS} signal. The time between the last falling edge of the CLK signal and the rising edge of the \overline{CS} must be at least 20 ns.

Table 11 SPI Block Data Bit Description

Data Bit	Name	Description (Logic High)	Power ON State
15	GS	LNA Gain reduction	low
14	–	Not used	low
13	AMUX2	Analog multiplexer control bit 2	high
12	DIS_PA	Disable Power Amplifier	high
11	Test Bit	Test bit, must be low otherwise malfunction	low
10	Test Bit	Test bit, must be low otherwise malfunction	low
9	Test Bit	Test bit, must be low otherwise malfunction	low
8	AMUX1	Analog multiplexer control bit 1	low
7	AMUX0	Analog multiplexer control bit 0	low
6	DIS_DIV64k	Disable 64k divider	low
5	DIS_DIV16	Disable 16 divider	low
4	PC2_BUF	High LO buffer output power, need to be low otherwise increased current consumption	low
3	PC1_BUF	High TX buffer output power	low
2	PC2_PA	TX power reduction bit 2	high
1	PC1_PA	TX power reduction bit 1	high
0	PC0_PA	TX power reduction bit 0	high

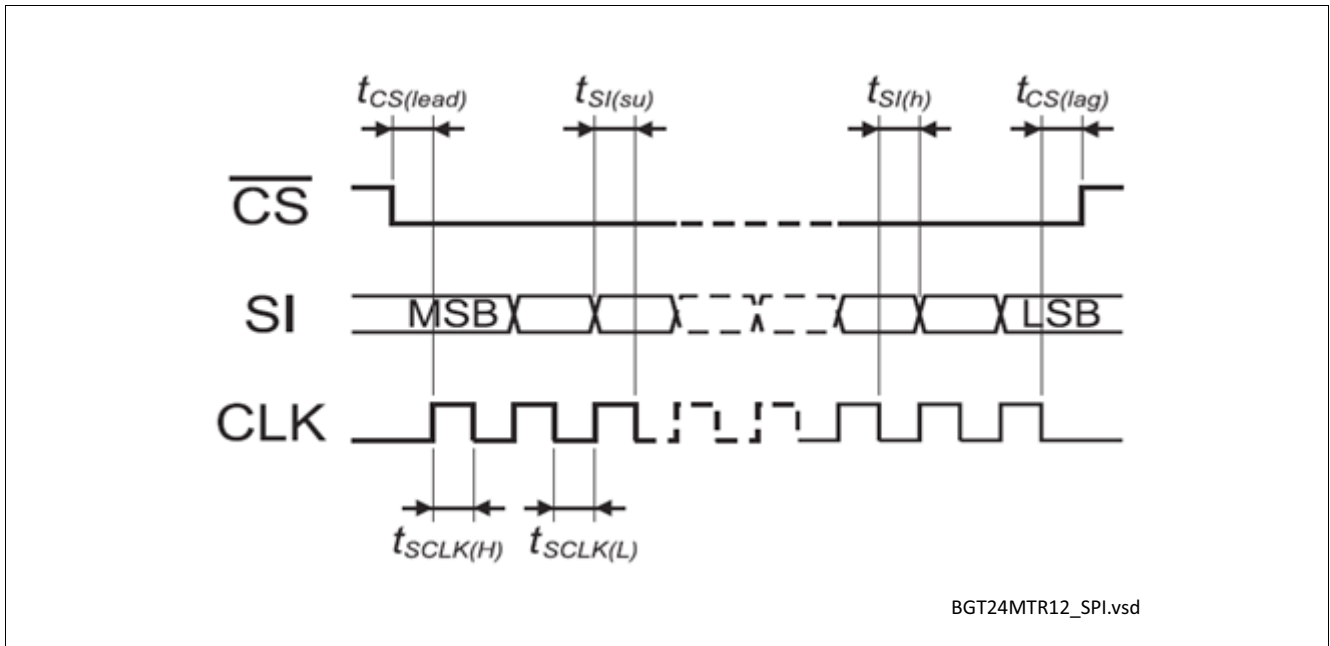

Figure 3 Timing Diagram of the SPI

Table 12 SPI Timing and Logic Levels

Parameter	Symbol	Values			Unit
		Min.	Typ.	Max.	
Serial clock frequency	f_{SCLK}	0	–	50	MHz
Serial clock high time	$f_{SCLK(H)}$	10	–	–	ns
Serial clock low time	$t_{SCLK(L)}$	10	–	–	ns
Chip select lead time	$t_{CS(lead)}$	20	–	–	ns
Chip select lag time	$t_{CS(lag)}$	20	–	–	ns
Data setup time	$t_{SI(su)}$	10	–	–	ns
Data hold time	$t_{SI(h)}$	10	–	–	ns
Low level (SI, CLK, \overline{CS})	$V_{IN(L)}$	0	–	0.8	V
High level (SI, CLK, \overline{CS})	$V_{IN(H)}$	2.0	–	V_{CC}	V
Input capacitance (SI, CLK, \overline{CS})	C_{IN}	–	–	2	pF
Input current (SI, CLK, \overline{CS})	I_{IN}	-150	–	150	μA

Table 13 Truth Table AMUX

Output signal ANA	AMUX2	AMUX1	AMUX0
$V_{OUT,TX}$	low	low	low
$V_{REF,TX}$	low	low	high
$V_{OUT,LO}$	low	high	low
$V_{REF,LO}$	low	high	high
V_{TEMP}	high	low	low
Test_Signal1	high	low	high

Table 13 Truth Table AMUX (cont'd)

Output signal ANA	AMUX2	AMUX1	AMUX0
Test_Signal2	high	high	low
Test_Signal2	high	high	high

3.4 Application Board

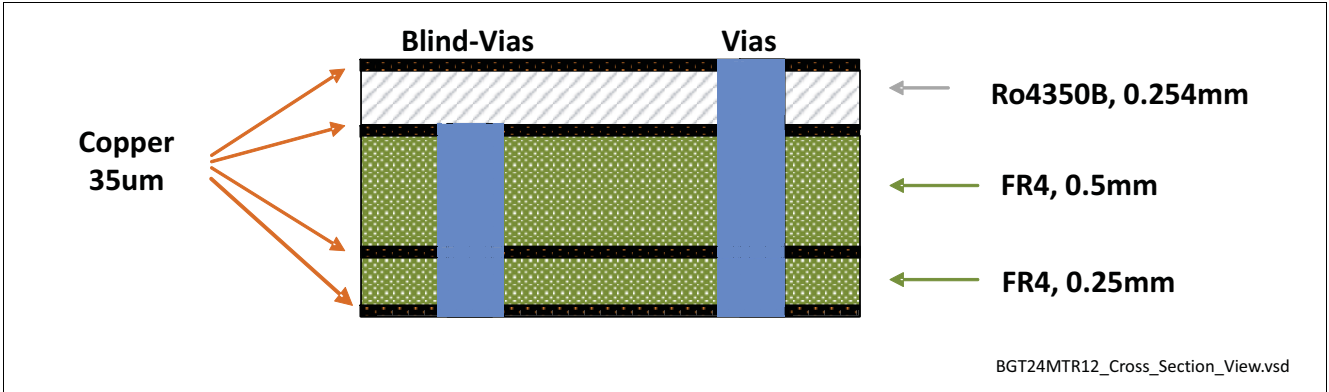

Figure 4 Cross-Section View of Application Board

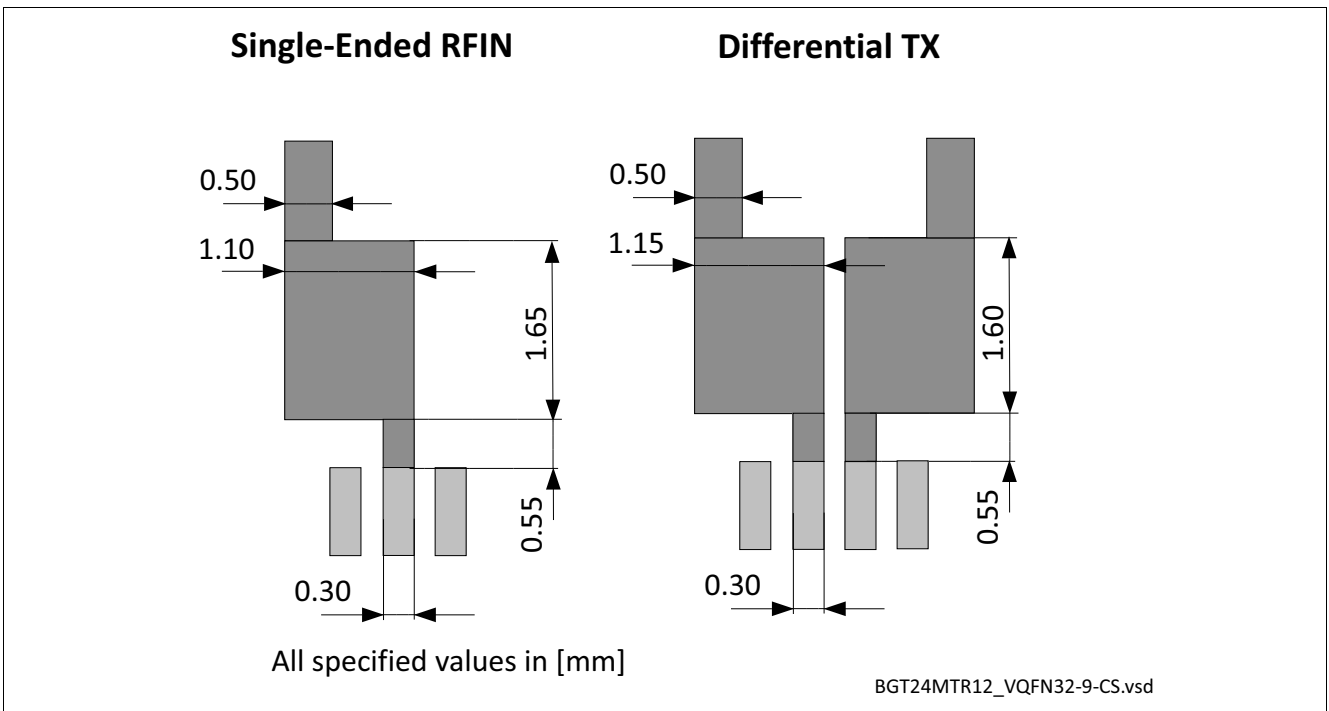

Figure 5 Detail of Compensation Structure (valid for appl. board mat. Ro4350B, 0.254mm acc. to Fig. 5)

3.5 Equivalent Circuit Diagram of MMIC Interfaces

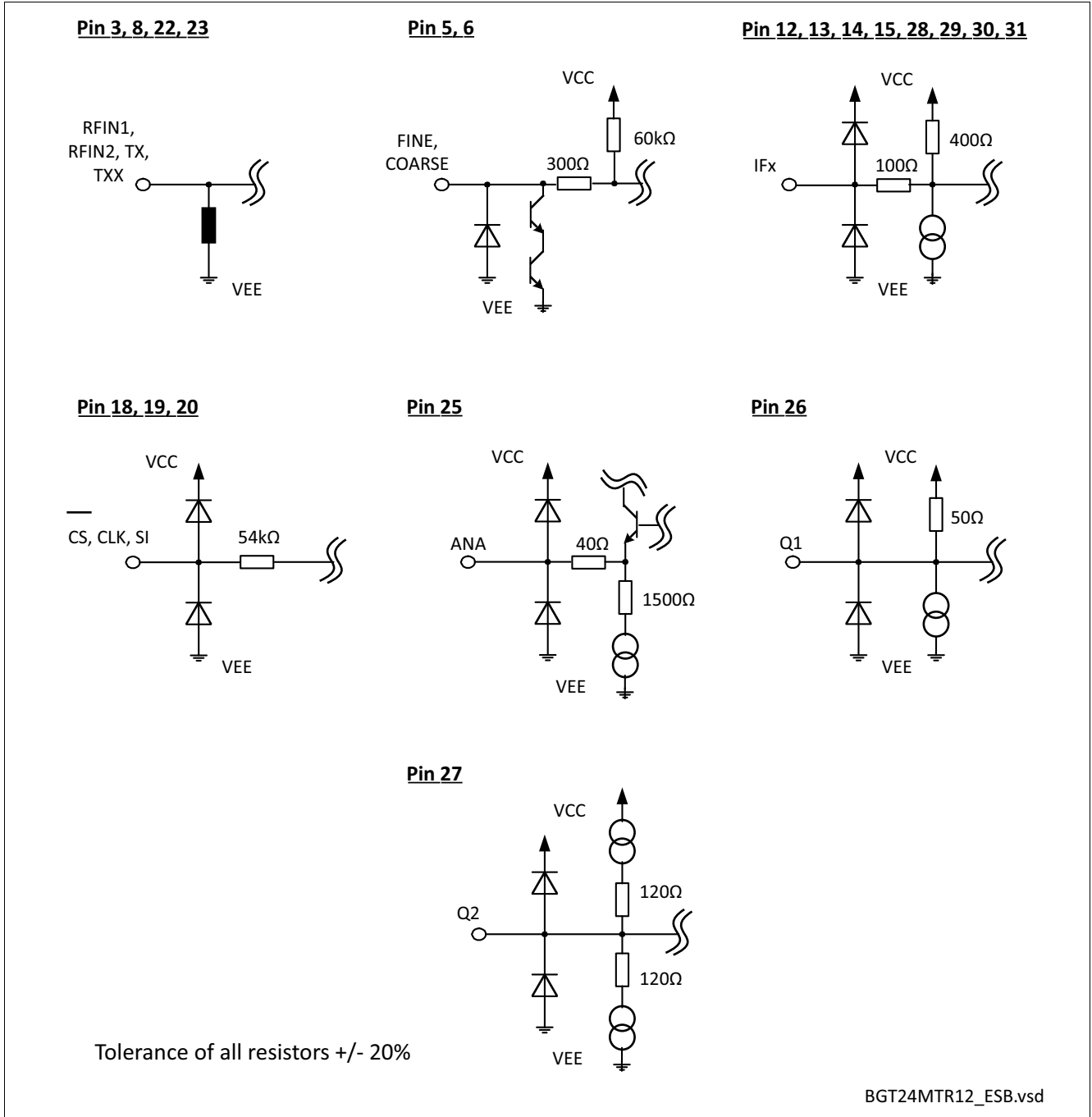

Figure 7 Equivalent Circuit Diagram of MMIC Interfaces

4 Physical Characteristics

4.1 Package Footprint

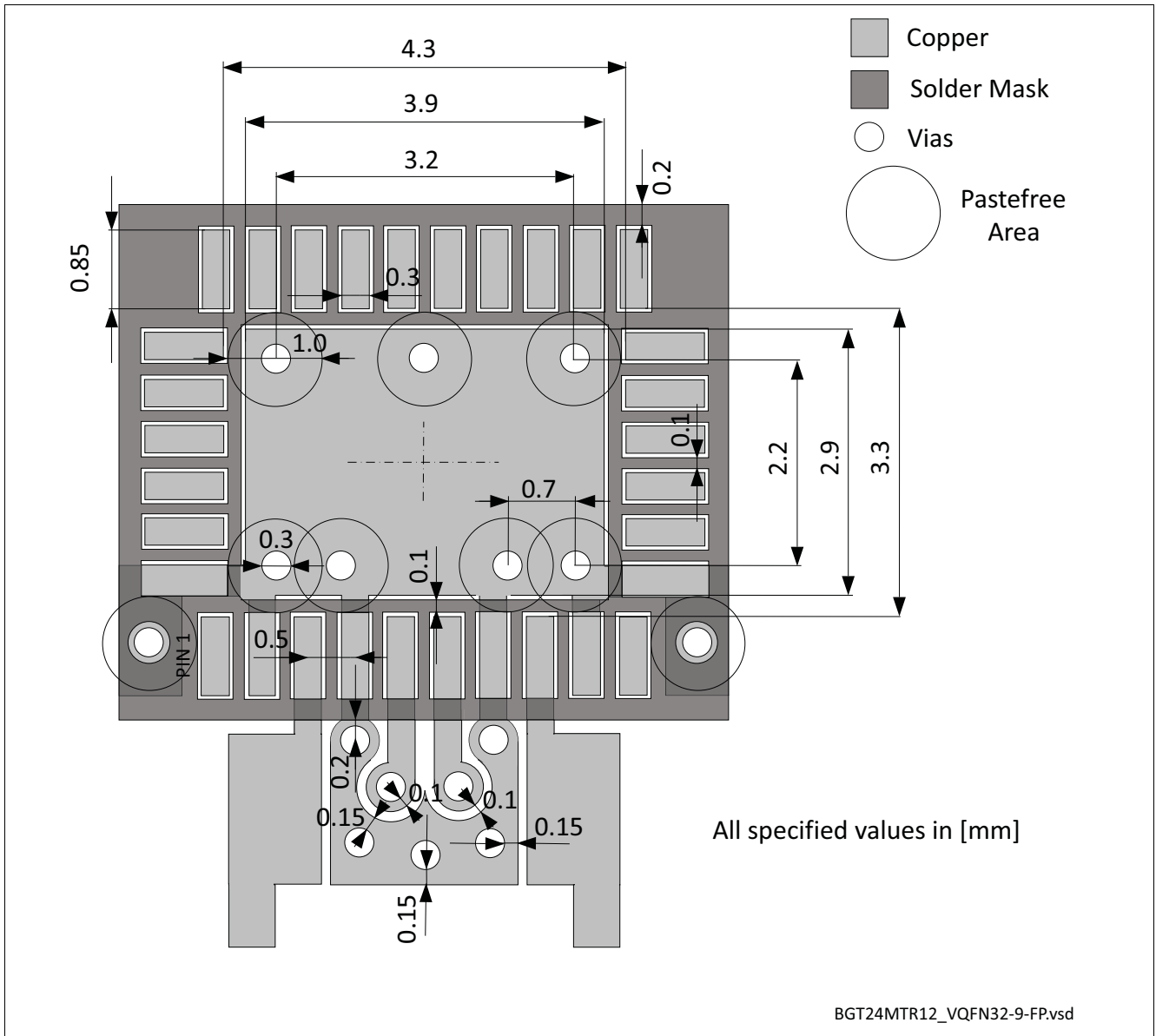

Figure 8 Recommended Footprint and Stencil Layout for the VQFN32-9 Package

4.2 Reflow Profile

Soldering process qualified during qualification with "Preconditioning MSL-3: 30°C. 60%r.h., 192h, according to JEDEC JSTD20".

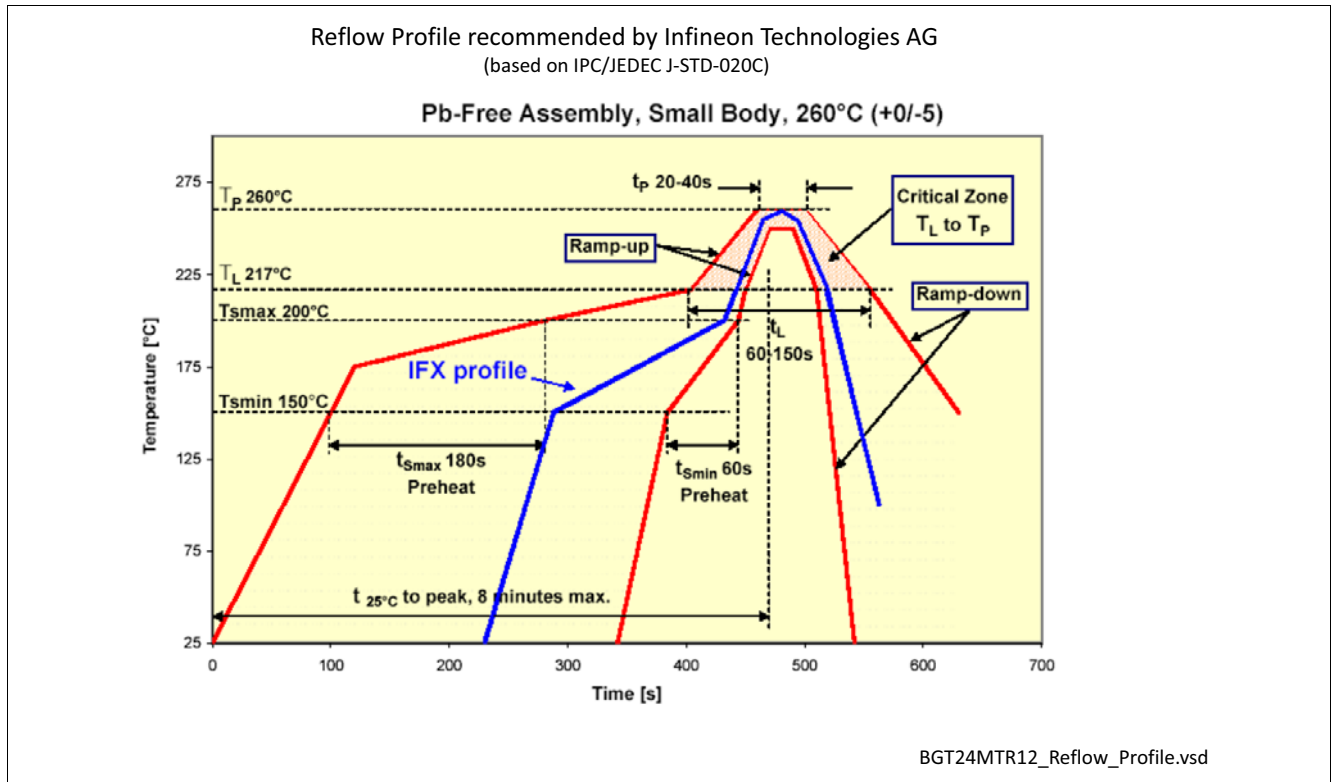

Figure 9 Reflow Profile for BGT24MTR12 (VQFN32-9)

4.3 Package Dimensions

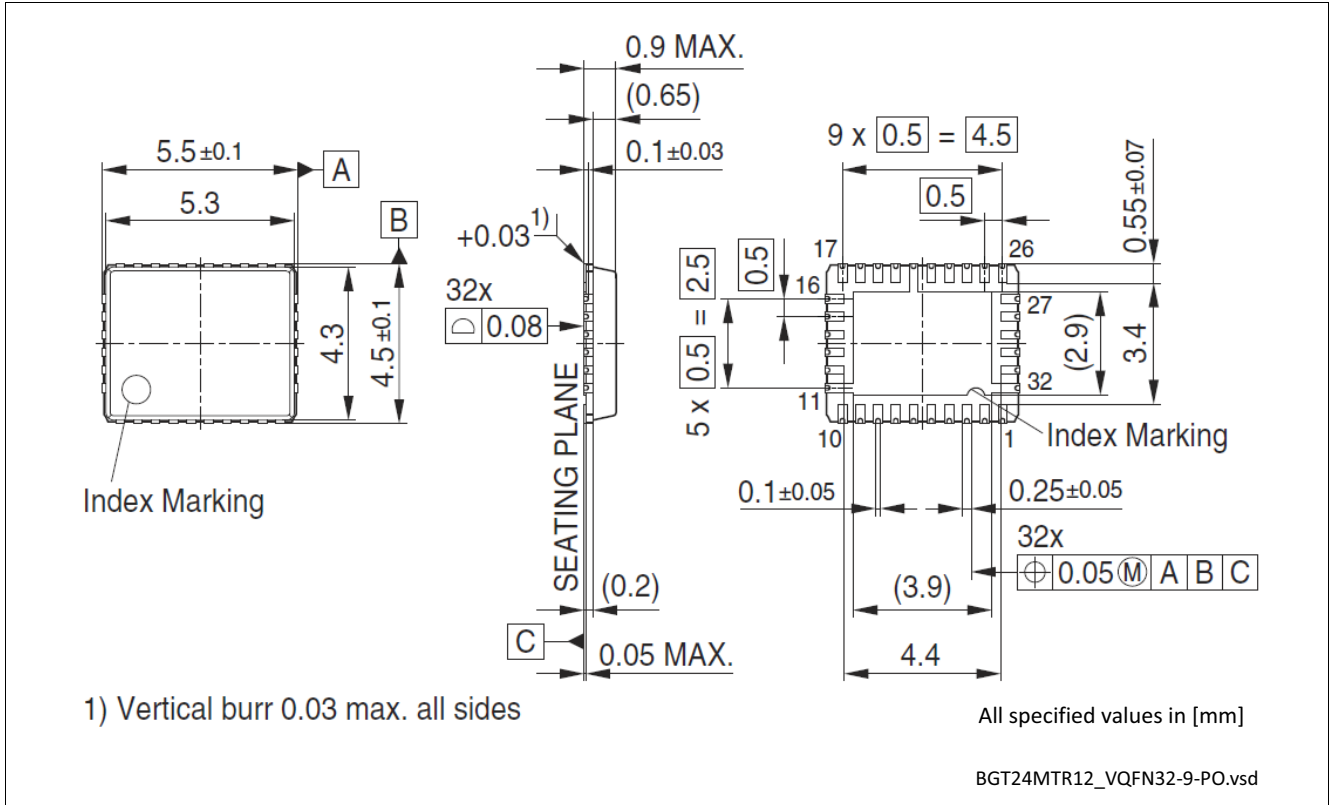

Figure 10 Package Outline (Top, Side and Bottom View)

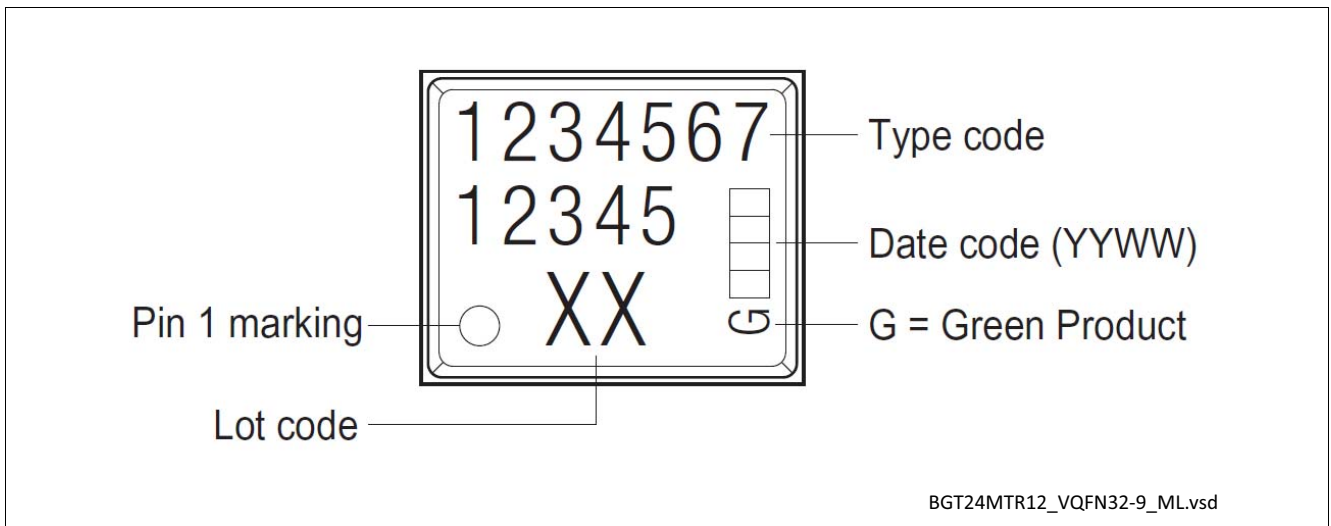



Figure 11 Marking Layout VQFN32-9

www.infineon.com



Published by Infineon Technologies AG

Looking for pricing, stock, or lifecycle information?

Click below to explore more details on WIN SOURCE:

-  [View BGT24MTR12E6327XUMA1 on WIN SOURCE](#)
-  [Infineon Technologies Information](#)

Optimize Your Supply Chain with WIN SOURCE Solutions

-  Global Sourcing Solution
-  Obsolete Management
-  Cost Control Management
-  Shortage Management
-  Alternative Solution
-  Excess Inventory Management