



**THE DATASHEET OF
BGS12PN10E6327XTSA1**



BGS12PN10

SPDT high linearity, high power RF Switch

Data Sheet

Revision 1.2 - 2016-07-07

Edition 2016-07-07

**Published by
Infineon Technologies AG
81726 Munich, Germany**

**©2012 Infineon Technologies AG
All Rights Reserved.**

Legal Disclaimer

The information given in this document shall in no event be regarded as a guarantee of conditions or characteristics. With respect to any examples or hints given herein, any typical values stated herein and/or any information regarding the application of the device, Infineon Technologies hereby disclaims any and all warranties and liabilities of any kind, including without limitation, warranties of non-infringement of intellectual property rights of any third party.

Information

For further information on technology, delivery terms and conditions and prices, please contact the nearest Infineon Technologies Office (www.infineon.com).

Warnings

Due to technical requirements, components may contain dangerous substances. For information on the types in question, please contact the nearest Infineon Technologies Office.

Infineon Technologies components may be used in life-support devices or systems only with the express written approval of Infineon Technologies, if a failure of such components can reasonably be expected to cause the failure of that life-support device or system or to affect the safety or effectiveness of that device or system. Life support devices or systems are intended to be implanted in the human body or to support and/or maintain and sustain and/or protect human life. If they fail, it is reasonable to assume that the health of the user or other persons may be endangered.

Revision History

Document No.: BGS12PN10_v1.2.pdf

Revision History: 1.2

Previous Version: 1.1

Page	Subjects (major changes since last revision)
1	title updated
5	key features updated

Trademarks of Infineon Technologies AG

AURIX™, C166™, CanPAK™, CIPOS™, CIPURSE™, CoolGaN™, CoolMOS™, CoolSET™, CoolSiC™, CORECONTROL™, DAVE™, DI-POL™, EasyPIM™, EconoBRIDGE™, EconoDUAL™, EconoPACK™, EconoPIM™, EiceDRIVER™, eupec™, FCOS™, HITFET™, HybridPACK™, ISOFACE™, I²RF™, IsoPACK™, MIPAQ™, ModSTACK™, my-d™, NovalithIC™, OmniTune™, OptiMOS™, ORIGA™, OPTIGA™, PROFET™, PRO-SIL™, PRIMARION™, PrimePACK™, RASIC™, ReverSave™, SatRIC™, SIEGET™, SIPMOS™, SOLID FLASH™, SmartLEWIS™, TEMPFET™, thinQ!™, TriCore™, TRENCHSTOP™.

Other Trademarks

Advance Design System™ (ADS) of Agilent Technologies, AMBA™, ARM™, MULTI-ICE™, PRIMECELL™, REALVIEW™, THUMB™ of ARM Limited, UK. AUTOSAR™ is licensed by AUTOSAR development partnership. Bluetooth™ of Bluetooth SIG Inc. CAT-iq™ of DECT Forum. COLOSSUS™, FirstGPS™ of Trimble Navigation Ltd. EMV™ of EMVCo, LLC (Visa Holdings Inc.). EPCOS™ of Epcos AG. FLEXGO™ of Microsoft Corporation. FlexRay™ is licensed by FlexRay Consortium. HYPERTERMINAL™ of Hilgraeve Incorporated. IEC™ of Commission Electrotechnique Internationale. IrDA™ of Infrared Data Association Corporation. ISO™ of INTERNATIONAL ORGANIZATION FOR STANDARDIZATION. MATLAB™ of MathWorks, Inc. MAXIM™ of Maxim Integrated Products, Inc. MICROTEC™, NUCLEUS™ of Mentor Graphics Corporation. Mifare™ of NXP. MIPI™ of MIPI Alliance, Inc. MIPS™ of MIPS Technologies, Inc., USA. muRata™ of MURATA MANUFACTURING CO., MICROWAVE OFFICE™ (MWO) of Applied Wave Research Inc., OmniVision™ of OmniVision Technologies, Inc. Openwave™ Openwave Systems Inc. RED HAT™ Red Hat, Inc. RFMD™ RF Micro Devices, Inc. SIRIUS™ of Sirius Satellite Radio Inc. SOLARIS™ of Sun Microsystems, Inc. SPANSION™ of Spansion LLC Ltd. Symbian™ of Symbian Software Limited. TAIYO YUDEN™ of Taiyo Yuden Co. TEAKLITE™ of CEVA, Inc. TEKTRONIX™ of Tektronix Inc. TOKO™ of TOKO KABUSHIKI KAISHA TA. UNIX™ of X/Open Company Limited. VERILOG™, PALLADIUM™ of Cadence Design Systems, Inc. VLYNQ™ of Texas Instruments Incorporated. VXWORKS™, WIND RIVER™ of WIND RIVER SYSTEMS, INC. ZETEX™ of Diodes Zetex Limited.

Last Trademarks Update 2012-12-13

Contents

1	Features	5
2	Product Description	5
3	Maximum Ratings	6
4	Operation Ranges	7
5	Logic Table	7
6	RF Characteristics	8
7	RF large signal parameter	9
8	Package Outline and Pin Configuration	10
9	RF measurements	14

List of Figures

1	BGS12PN10 block diagram	6
2	Pinout (top view)	10
3	Package Dimensions Drawing	11
4	Land pattern and stencil mask	11
5	Tape drawing	12
6	Package marking: Date code digits Y and W are found in Table 13/14	13
7	Insertion loss and return loss at room temperature	14
8	Port to port isolation at room temperature	15
9	Insertion loss vs input power and temperature	15
10	H2/H3 harmonic output power vs frequency at room temperature	16

List of Tables

1	Ordering Information	6
2	Maximum Ratings, Table I	6
3	Maximum Ratings, Table II	7
4	Operation Ranges	7
5	Logic Table	7
6	RF Specifications	8
7	RF large signal Specifications	9
8	Logic Table	9
9	Logic Table	9
10	Logic Table	9
11	Pin description	10
12	Mechanical data	10
13	Operation Ranges	13
14	Operation Ranges	13

BGS12PN10 SPDT high linearity, high power RF Switch

1 Features

- High max RF power: 40 dBm CW @ 900 MHz, room temperature
- Two ultra-low loss ports:
 - 0.17 dB @ $f=0.9$ GHz, $P_{IN}=38$ dBm
 - 0.22 dB @ $f=1.9$ GHz, $P_{IN}=38$ dBm
 - 0.26 dB @ $f=2.7$ GHz, $P_{IN}=33$ dBm
 - 0.37 dB @ $f=3.6$ GHz, $P_{IN}=33$ dBm
 - 0.68 dB @ $f=5.8$ GHz, $P_{IN}=33$ dBm
- No DC decoupling components required, if no external DC is applied on RF ports
- High ESD robustness
- Low harmonic generation
- High linearity: 75dBm IIP3
- No power supply blocking required
- Supply voltage range: 1.8 to 3.6 V
- No insertion loss change within supply voltage range
- No linearity change within supply voltage range
- Suitable for EDGE / C2K / LTE / WCDMA / SV-LTE Applications
- Mobile cellular Rx/Tx applications, suitable for LTE/3G
- Applicable for main path and entire RF Front-end without any power restrictions in mobile communication
 - DL/UL CA and MIMO
 - Micro/Pico Cells/Cellular base stations
 - Test equipment
 - Suitable for SV-LTE
- 0.5 to 6.0 GHz coverage
- Small form factor 1.1 mm x 1.5 mm
- 400 μ m pad pitch
- RoHS and WEEE compliant package

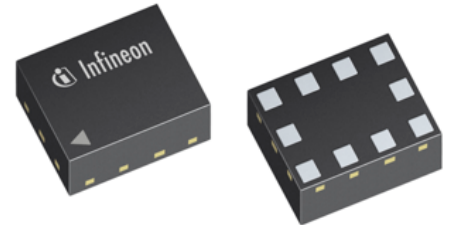

2 Product Description

The BGS12PN10 is a Single Pole Dual Throw (SPDT) high power RF switch optimized for mobile phone applications up to 6.0 GHz. This single supply chip integrates on-chip CMOS logic driven by a simple, CMOS or TTL compatible control input signal. Unlike GaAs technology, the 0.1 dB compression point exceeds the switch maximum input power level, resulting in linear performance at all signal levels and external DC blocking capacitors at the RF ports are only required if DC voltage is applied externally.

Table 1: Ordering Information

Type	Package	Marking	Chip
BGS12PN10	TSNP10-1	2P	M4821A

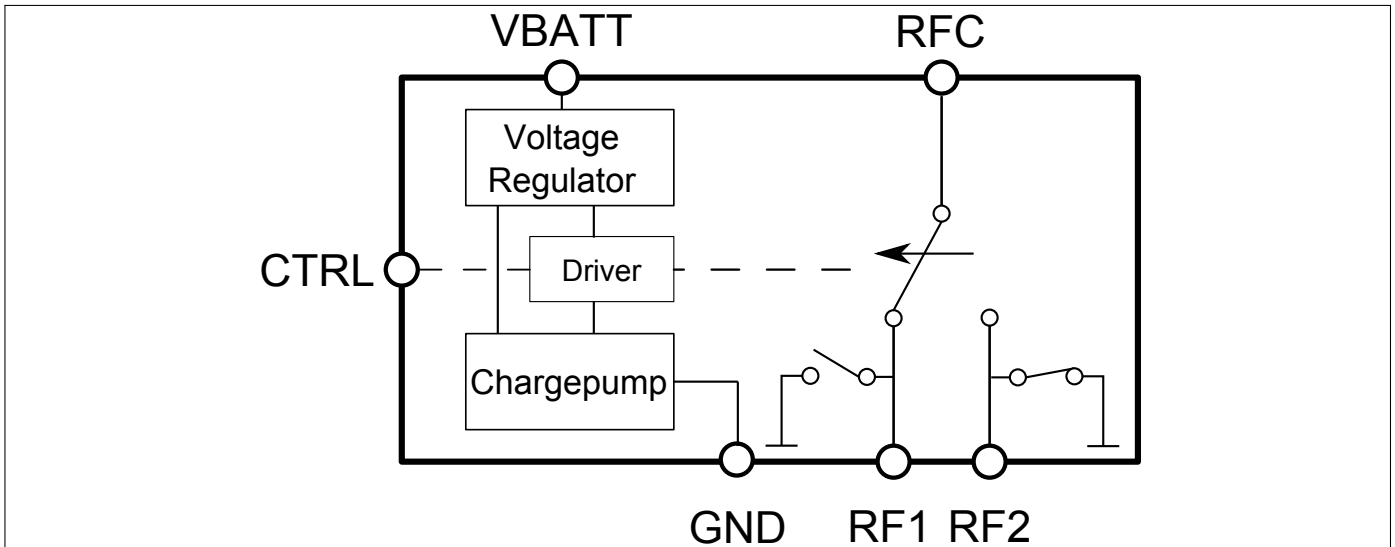
Figure 1: BGS12PN10 block diagram

3 Maximum Ratings

Table 2: Maximum Ratings, Table I at $T_A = 25\text{ °C}$, unless otherwise specified

Parameter	Symbol	Values			Unit	Note / Test Condition
		Min.	Typ.	Max.		
Frequency Range	f	0.5	–	6.0	GHz	¹⁾
Supply voltage	V_{DD}	-0.5	–	3.6	V	–
Storage temperature range	T_{STG}	-55	–	150	°C	–
RF input power	P_{RF_TRX}	–	–	40	dBm	CW, 900 MHz
ESD capability Human Body Model	$V_{ESD_{HBM}}$	-1.5	–	+1.5	kV	²⁾
ESD capability RFC port ³⁾	$V_{ESD_{RFC}}$	-10	–	+10	kV	On application board with 27nH shunt inductor
Junction temperature	T_j	–	–	125	°C	–

¹⁾ Switch has no highpass response. There is also a high ohmic DC to the RF path. The DC voltage at RF ports V_{RFDC} has to be 0V.

²⁾ Field-Induced Charged-Device Model JESD22-C101. Simulates charging/discharging events that occur in production equipment and processes. Potential for CDM ESD events occurs whenever there is metal-to-metal contact in manufacturing.

³⁾ Human Body Model ANSI/ESDA/JEDEC JS-001-2012 ($R = 1.5\text{ k}\Omega$, $C = 100\text{ pF}$).

⁴⁾ IEC 61000-4-2 ($R = 330\text{ }\Omega$, $C = 150\text{ pF}$), contact discharge.

Table 3: Maximum Ratings, Table II at $T_A = 25\text{ °C}$, unless otherwise specified

Parameter	Symbol	Values			Unit	Note / Test Condition
		Min.	Typ.	Max.		
Maximum DC-voltage on RF-Ports and RF-Ground	V_{RFDC}	0	–	0	V	No DC voltages allowed on RF-Ports
Control Voltage Levels	V_{CTRL}	-0.7	–	3.3	V	–

4 Operation Ranges

Table 4: Operation Ranges

Parameter	Symbol	Values			Unit	Note / Test Condition
		Min.	Typ.	Max.		
Supply voltage	V_{DD}	1.8	2.85	3.6	V	–
Supply current ¹⁾	I_{DD}	–	75	120	μA	–
Control voltage low	$V_{Ctrl,low}$	0		0.45	V	–
Control voltage high	$V_{Ctrl,high}$	1.2	1.8	2.85	V	$V_{Ctrl,high} \ll V_{DD}$
Control current low	$I_{Ctrl,low}$	-1	0	1	μA	–
Control current high	$I_{Ctrl,high}$	-1	0	1	μA	$V_{Ctrl,high} \ll V_{DD}$
Ambient temperature	T_A	-30	25	85	$^{\circ}C$	–
RF switching time ²⁾	t_{sw}	1	3.5	5	μS	–
Startup time ²⁾	t_{st}		10	30	μS	–

¹⁾ $T_A = -30\text{ °C} - +85\text{ °C}$, $V_{BATT} = 1.8 - 3.6\text{ V}$
²⁾, Represents actual alpha status. To be updated.

5 Logic Table

Table 5: Logic Table

CTRL	Mode
0	RF1 connected to RFC
1	RF2 connected to RFC

Confidential

6 RF Characteristics

Table 6: RF Specifications

Parameter	Symbol	Values			Unit	Note / Test Condition	
		Min.	Typ.	Max.			
Insertion Loss							
698 - 960 MHz	<i>IL</i>	–	0.16	0.25	dB	$V_{DD} = 1.8 - 3.6 V$, $T_A = -30 \dots +85 \text{ }^\circ\text{C}$, $Z_0 = 50 \Omega$, P_{IN} up to 38 dBm	
1710 - 1980 MHz		–	0.22	0.29	dB		
1981 - 2170 MHz		–	0.23	0.3	dB		
2171 - 2690 MHz		–	0.26	0.35	dB		
3400 - 3800 MHz		–	0.37	0.49	dB		
5150 - 5850 MHz		–	0.68	0.99	dB		
Return Loss							
All Ports @ 698 - 960 MHz	<i>RL</i>	25	30	–	dB		
All Ports @ 1710 - 1980 MHz		19	22	–	dB		
All Ports @ 1981 - 2170 MHz		18	21	–	dB		
All Ports @ 2171 - 2690 MHz		17	19	–	dB		
All Ports @ 3400 - 3800 MHz		13	17	–	dB		
All Ports @ 5150 - 5850 MHz		10	12	–	dB		
Isolation RFC							
698 - 915 MHz	<i>ISO</i>	36	39	–	dB		
1710 - 1980 MHz		30	32	–	dB		
1981 - 2170 MHz		28	29	–	dB		
2171 - 2690 MHz		26	27	–	dB		
3400 - 3800 MHz		22	23	–	dB		
5150 - 5850 MHz		16	17	–	dB		
Isolation RF1,2 - RF2,1							
698 - 915 MHz	<i>ISO</i>	49	54	–	dB		
1710 - 1980 MHz		39	40	–	dB		
1981 - 2170 MHz		37	38	–	dB		
2170 - 2690 MHz		33	34	–	dB		
3400 - 3800 MHz		28	29	–	dB		
5150 - 5850 MHz		19	20	–	dB		

7 RF large signal parameter

Table 7: RF large signal specifications

Parameter	Symbol	Values			Unit	Note / Test Condition
		Min.	Typ.	Max.		
Harmonic Generation up to 12.75 GHz^(1,2,3)						
Second Order Harmonics	P_{H2}	–	-105	–	dBc	25 dBm, 50Ω, CW mode
Third Order Harmonics	P_{H3}	–	-115	–	dBc	25 dBm, 50Ω, CW mode
All RF Ports	P_{Hx}	–	-105	–	dBc	25 dBm, 50Ω, CW mode
Intermodulation Distortion IMD2^(1,2,3)						
IIP2, low	IIP2,l	–	115	–	dBm	IIP2 conditions table 8
IIP2, high	IIP2,h	–	125	–	dBm	
Intermodulation Distortion IMD3^(1,2,3)						
IIP3	IIP3	–	75	–	dBm	IIP3 conditions table 9
SV LTE Intermodulation^(1,2,3)						
IIP3,SVLTE	IIP3,SV	–	75	–	dBm	SV-LTE conditions table 10

¹⁾Terminating Port Impedance: $Z_0 = 50 \Omega$ ²⁾Supply Voltage: $V_{DD} = 1.8 - 3.6 V$ ³⁾On application board without any matching components

Table 8: IIP2 conditions table

Band	In-Band Frequency [MHz]	Blocker Frequency 1 [MHz]	Blocker Power 1 [dBm]	Blocker Frequency 2 [MHz]	Blocker Power 2 [dBm]
Band 1 Low	2140	1950	20	190	-15
Band 1 High	2140	1950	20	4090	-15
Band 5 Low	881.5	836.5	20	45	-15
Band 5 High	881.5	836.5	20	1718	-15

Table 9: IIP3 conditions table

Band	In-Band Frequency [MHz]	Blocker Frequency 1 [MHz]	Blocker Power 1 [dBm]	Blocker Frequency 2 [MHz]	Blocker Power 2 [dBm]
Band 1	2140	1950	20	1760	-15
Band 5	881.5	836.5	20	791.5	-15

Table 10: SV-LTE conditions table

Band	In-Band Frequency [MHz]	Blocker Frequency 1 [MHz]	Blocker Power 1 [dBm]	Blocker Frequency 2 [MHz]	Blocker Power 2 [dBm]
Band 5	872	827	23	872	14
Band 13	747	786	23	747	14
Band 20	878	833	23	2544	14

8 Package Outline and Pin Configuration

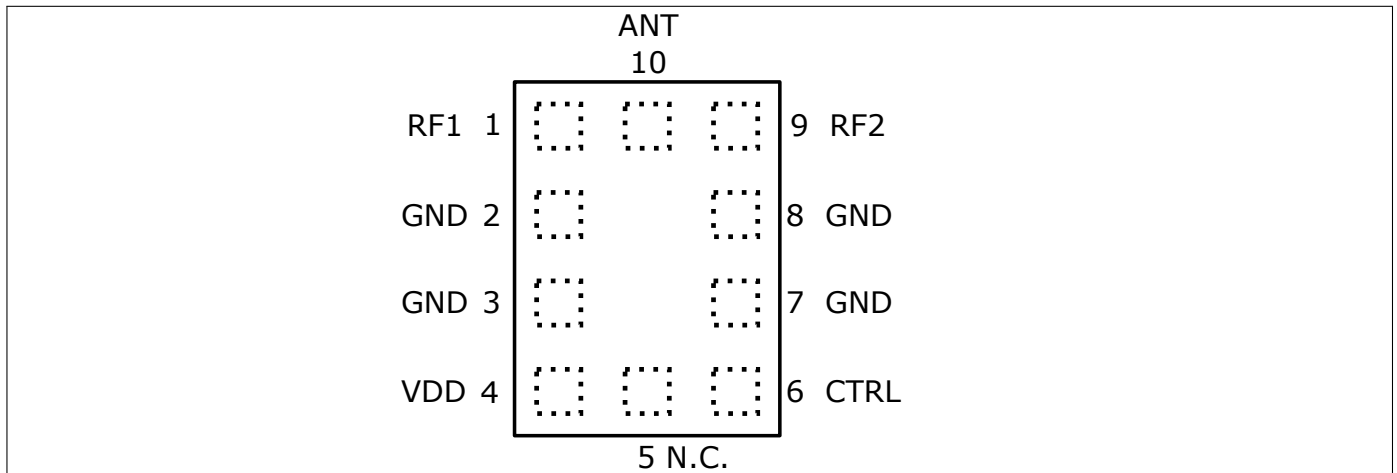

Figure 2: Pinout (top view)

Table 11: Pin Description

Pin No.	Name	Pin Type	Buffer Type	Function
1	RF1	I/O.		RF1
2	GND	GND		Ground
3	GND	GND		Ground
4	VDD	PWR		Supply voltage
5	N.C.	N.C.		Not connected
6	CTRL	I		Control Pin
7	GND	GND		Ground
8	GND	GND		Ground
9	RF2.	I/O		RF2
10	ANT	I/O		Common RF / Antenna

Table 12: Mechanical Data

Parameter	Symbol	Value	Unit
X-Dimension	<i>X</i>	1.1 ± 0.05	mm
Y-Dimension	<i>Y</i>	1.5 ± 0.05	mm
Size	<i>Size</i>	1.65	mm ²
Height	<i>H</i>	0.375	mm

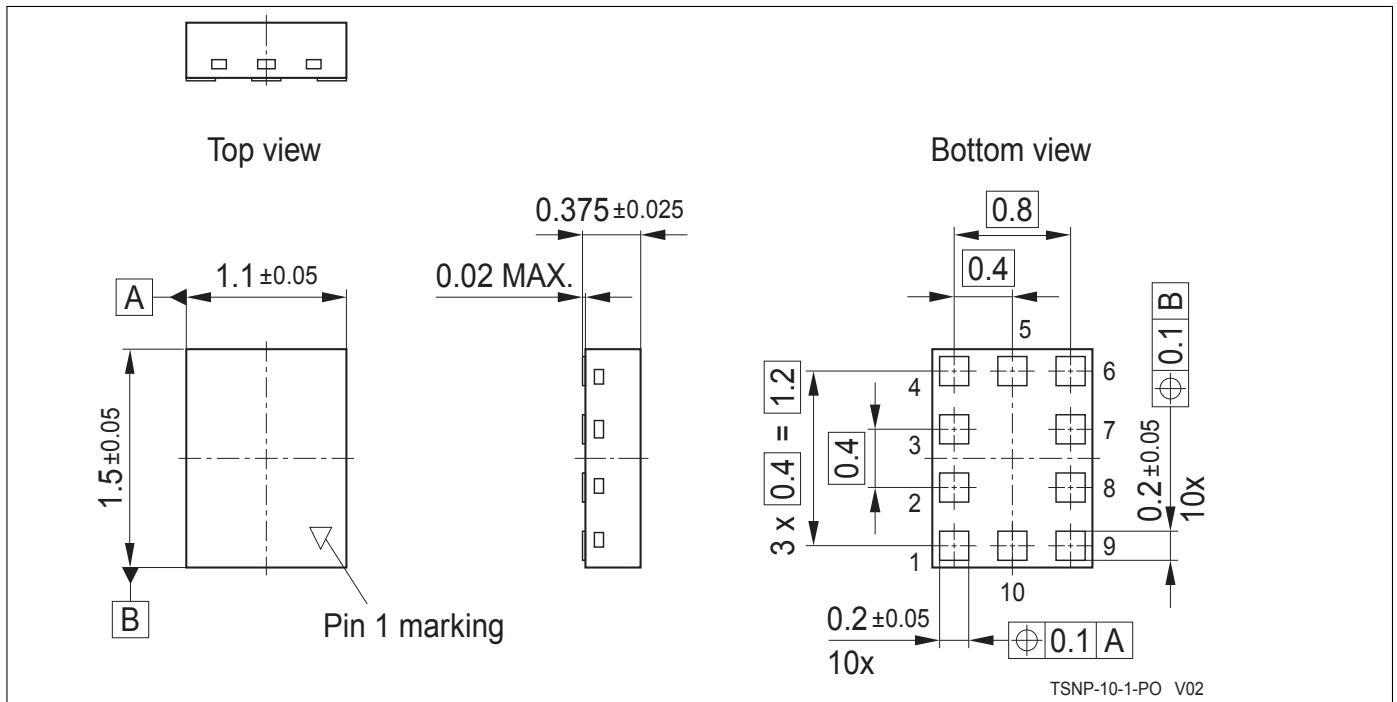

Figure 3: Package Dimensions Drawing

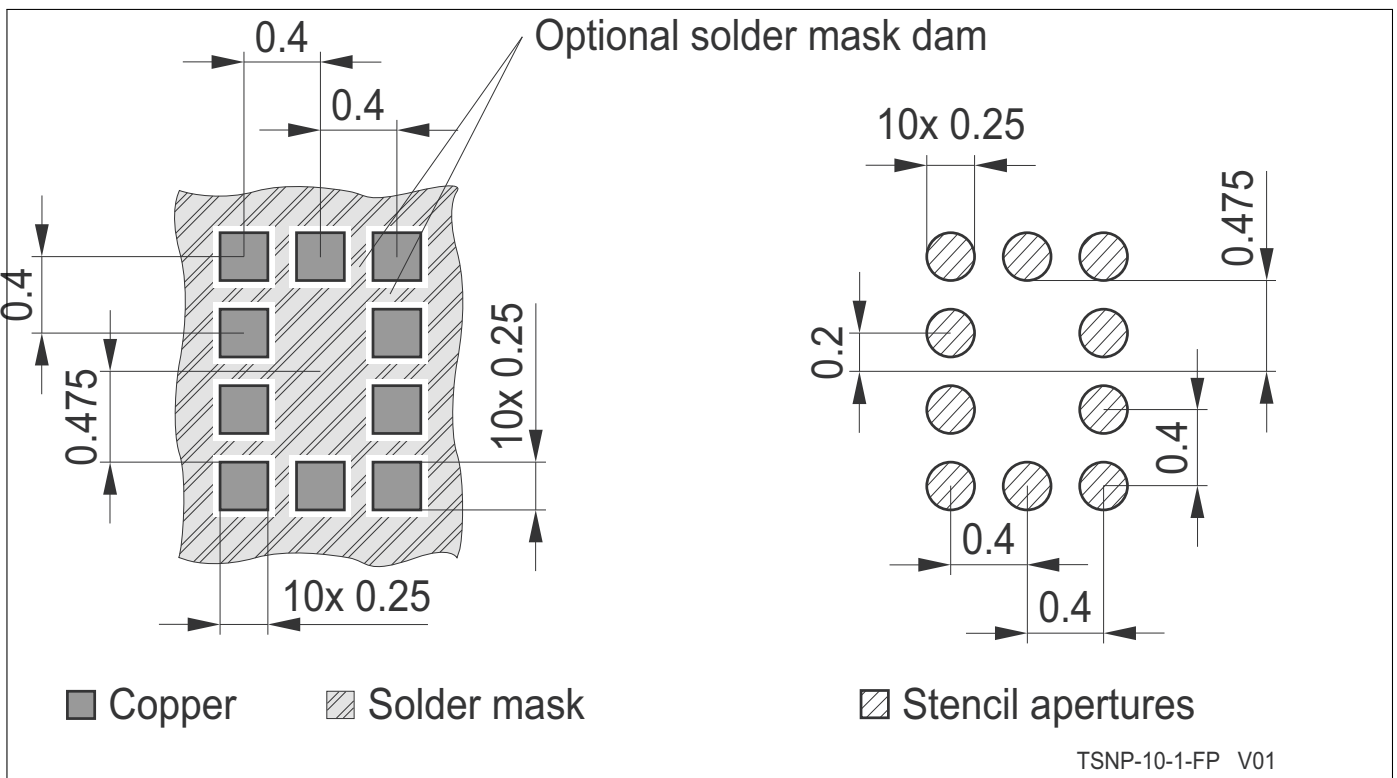

Figure 4: Land pattern and stencil mask

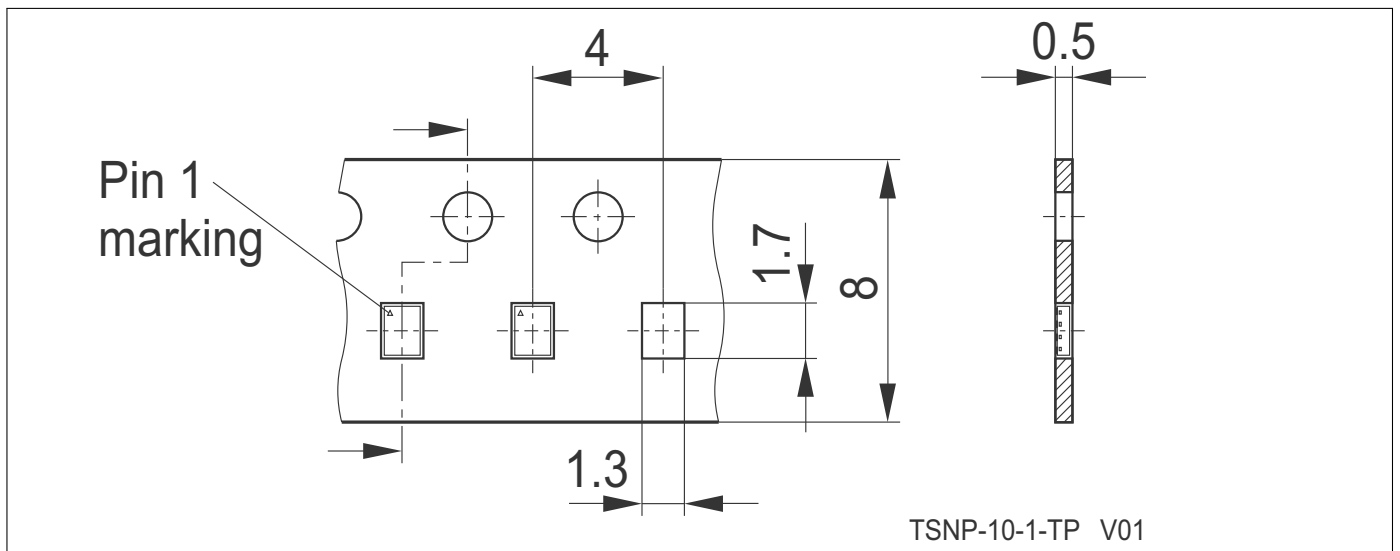

Figure 5: Tape drawing

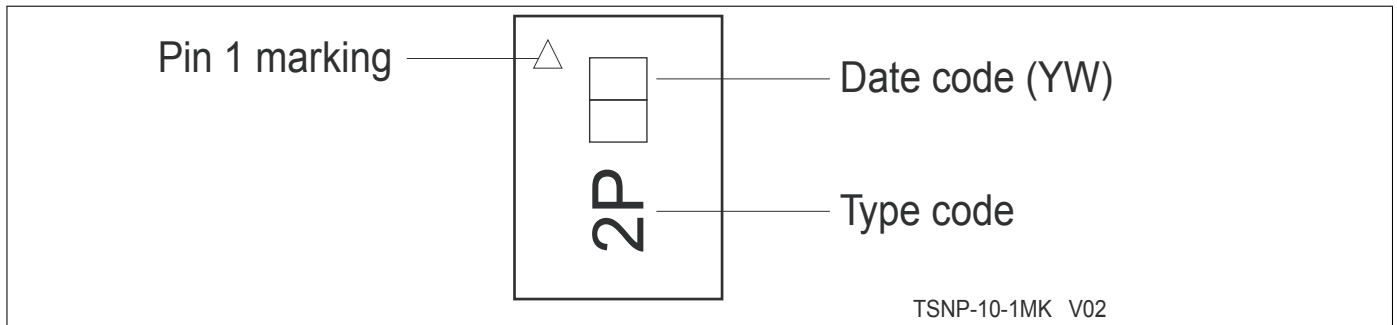

Figure 6: Package marking: Date code digits Y and W are found in Table 13/14

Table 13: Year date code marking - digit "Y"

Year	"Y"	Year	"Y"	Year	"Y"
2000	0	2010	0	2020	0
2001	1	2011	1	2021	1
2002	2	2012	2	2022	2
2003	3	2013	3	2023	3
2004	4	2014	4	2024	4
2005	5	2015	5	2025	5
2006	6	2016	6	2026	6
2007	7	2017	7	2027	7
2008	8	2018	8	2028	8
2009	9	2019	9	2029	9

Table 14: Week date code marking - digit "W"

Week	"W"	Week	"W"	Week	"W"	Week	"W"	Week	"W"
1	A	12	N	23	4	34	h	45	v
2	B	13	P	24	5	35	j	46	x
3	C	14	Q	25	6	36	k	47	y
4	D	15	R	26	7	37	l	48	z
5	E	16	S	27	a	38	n	49	8
6	F	17	T	28	b	39	p	50	9
7	G	18	U	29	c	40	q	51	2
8	H	19	V	30	d	41	r	52	3
9	J	20	W	31	e	42	s		
10	K	21	Y	32	f	43	t		
11	L	22	Z	33	g	44	u		

Confidential

9 RF measurements

All measurement data performed

- represents typical performance
- on evaluation PCB
- without external RF matching components
- load impedance: $Z_0 = 50 \Omega$
- deembedded PCB insertion loss
- supply voltage: 2.85 V (no change for 1.8-3.6 V due to internal voltage regulator)
- room temperature: 25°C

unless otherwise noted.

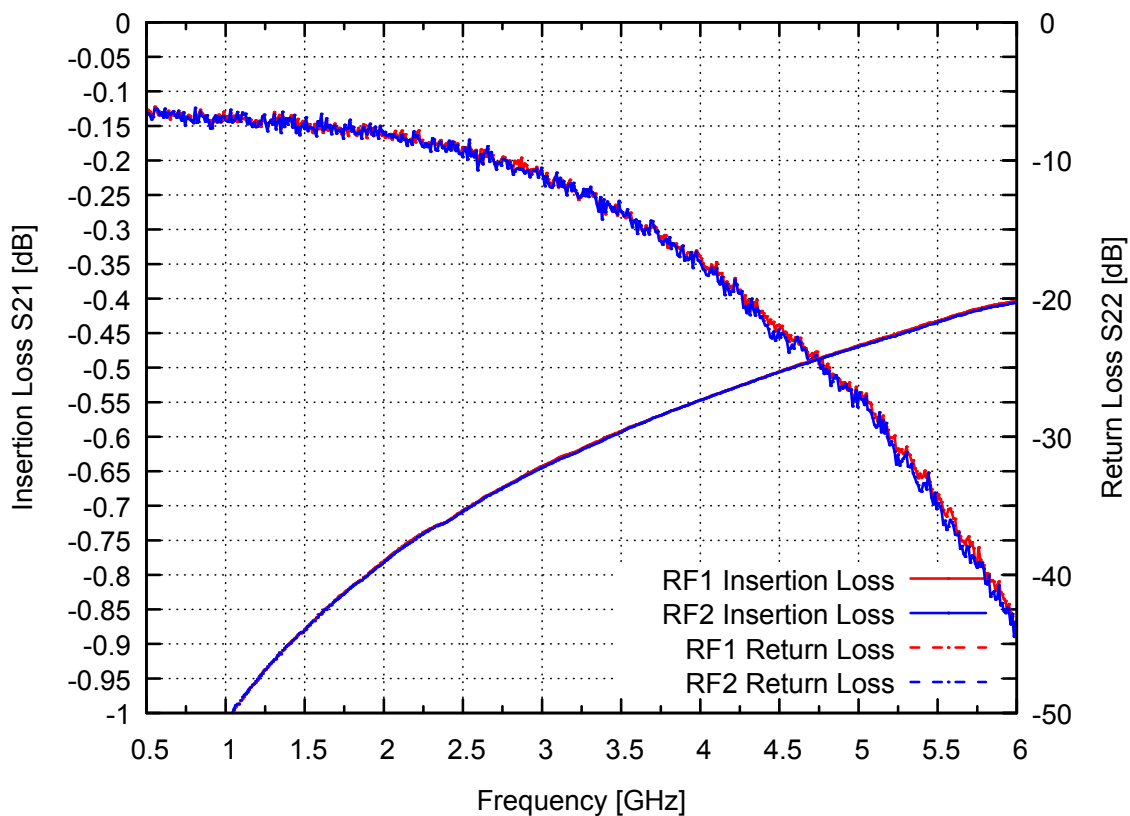

Figure 7: Insertion loss and return loss at room temperature

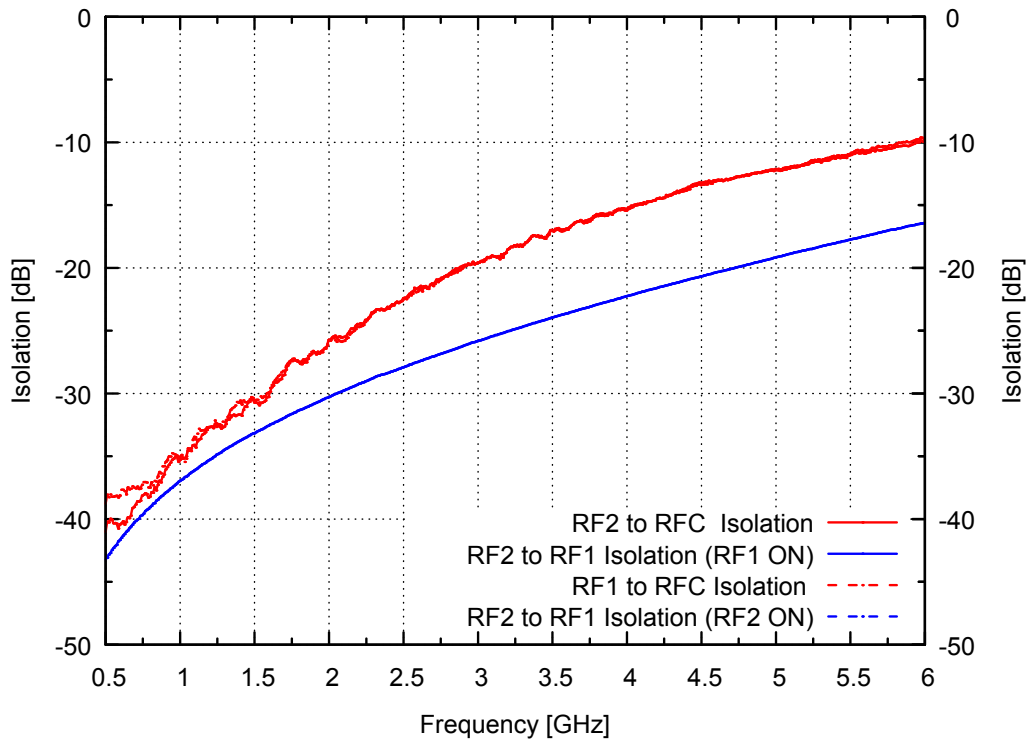

Figure 8: Port to port isolation at room temperature

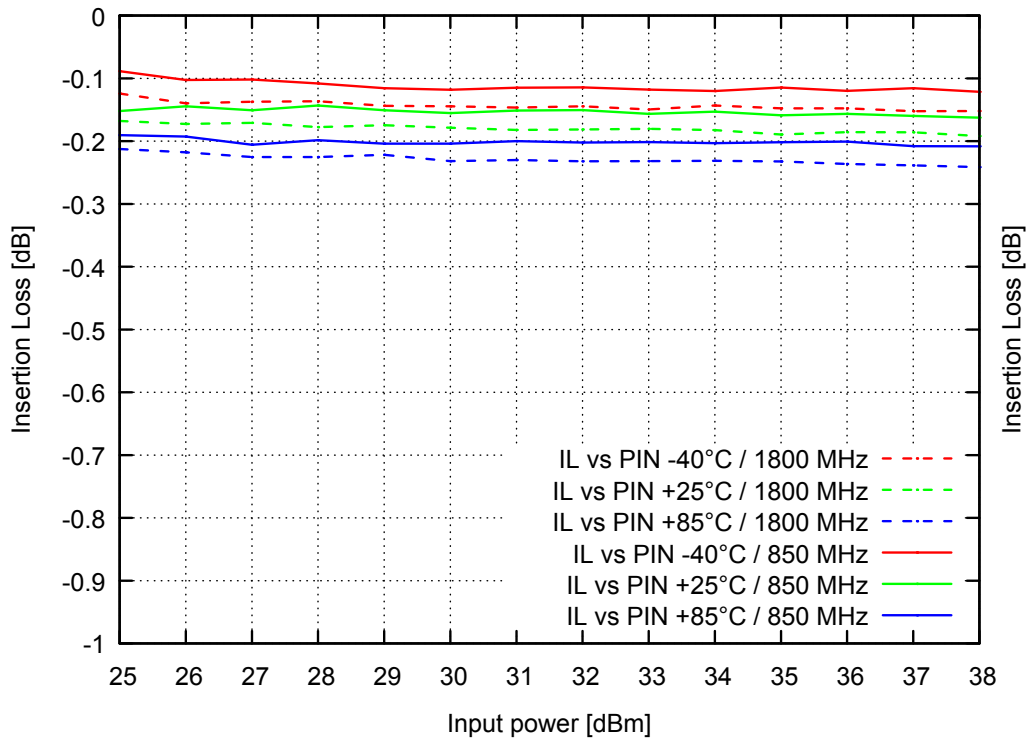

Figure 9: Insertion loss vs input power and temperature

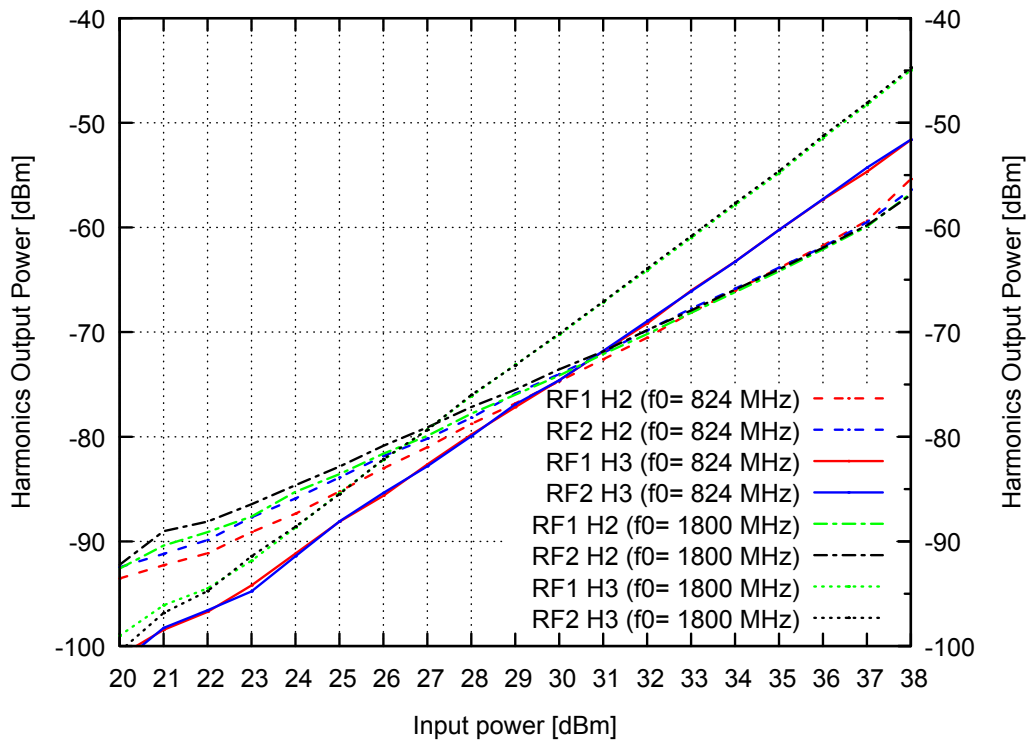



Figure 10: H2/H3 harmonic output power vs frequency at room temperature

www.infineon.com

Published by Infineon Technologies AG

Looking for pricing, stock, or lifecycle information?

Click below to explore more details on WIN SOURCE:

-  [View BGS12PN10E6327XTSA1 on WIN SOURCE](#)
-  [Infineon Technologies Information](#)

Optimize Your Supply Chain with WIN SOURCE Solutions

-  Global Sourcing Solution
-  Obsolete Management
-  Cost Control Management
-  Shortage Management
-  Alternative Solution
-  Excess Inventory Management