



**THE DATASHEET OF  
BA4558YFV-MGE2**



Operational Amplifier Series

# Automotive Low Noise Operational Amplifiers



## BA4558Yxxx-M

●General Description

BA4558Yxxx-M integrates two independent Op-Amps on a single chip. This Op-Amp has some features of low noise and low distortion characteristics and can operate from  $\pm 4.0V$  to  $\pm 15V$ (split supply). BA4558Yxxx-M is manufactured for automotive requirements of car navigation system, car audio, etc.

●Features

- AEC-Q100 Qualified
- High voltage gain
- low noise
- low distortion
- Wide operating supply voltage
- Internal ESD protection circuit
- Wide operating temperature Range

●Application

- Car Navigation System
- Car Audio

●Simplified schematic

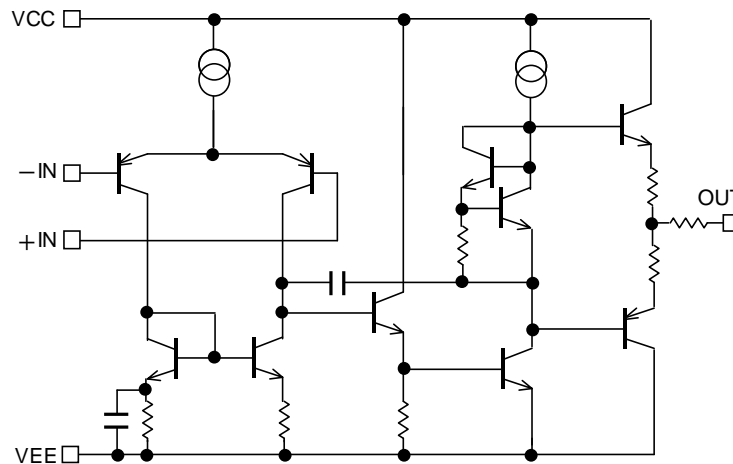

Figure 1. Simplified schematic (one channel only)

●Key Specifications

- Wide operating supply voltage  
(split supply):  $\pm 4.0V$  to  $\pm 15V$
- Wide Temperature Range:  $-40^{\circ}C$  to  $+105^{\circ}C$
- High Slew Rate:  $1V/\mu s$ (Typ.)
- Total Harmonic Distortion :  $0.005\%$ (Typ.)
- Input Referred Noise Voltage :  $12 nV/\sqrt{Hz}$  (Typ.)

●Packages

SOP8	W(Typ.) x D(Typ.) x (Max.) 5.00mm x 6.20mm x 1.71mm
SSOP-B8	3.00mm x 6.40mm x 1.35mm
MSOP8	2.90mm x 4.00mm x 0.90mm

○Product structure : Silicon monolithic integrated circuit ○This product is not designed protection against radioactive rays.

●Pin Configuration

BA4558YF-M : SOP8  
 BA4558YFV-M : SSOP-B8  
 BA4558YFVM-M : MSOP8

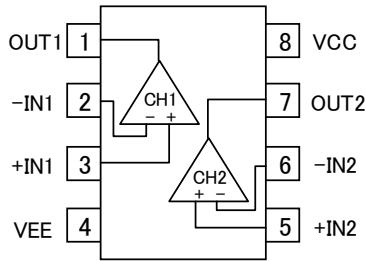

Pin No.	Symbol
1	OUT1
2	-IN1
3	+IN1
4	VEE
5	+IN2
6	-IN2
7	OUT2
8	VCC

Package		
SOP8	SSOP-B8	MSOP8
BA4558YF-M	BA4558YFV-M	BA4558YFVM-M

●Ordering Information



Parts Number. BA4558Yxxx	Package F : SOP8 FV : SSOP-B8 FVM: MSOP8	Packaging and forming specification M : Automotive (car navigation system, car audio, etc.) E2: Embossed tape and reel (SOP8/SSOP-B8) TR: Embossed tape and reel (MSOP8)
-----------------------------	---	--

●Line-up

Topr	Supply voltage	Number of channels	Package		Orderable Parts Number
-40°C to +105°C	±4.0V to ±15V	Dual	SOP8	Reel of 2500	BA4558YF-ME2
			SSOP-B8	Reel of 2500	BA4558YFV-ME2
			MSOP8	Reel of 3000	BA4558YFVM-MTR

## ● Absolute Maximum Ratings (Ta=25°C)

Parameter	Symbol	Ratings	Unit
Supply Voltage	VCC-VEE	+36	V
Power Dissipation	Pd	SOP8	775 <sup>*1*4</sup>
		SSOP-B8	625 <sup>*2*4</sup>
		MSOP8	600 <sup>*3*4</sup>
Differential Input Voltage <sup>*5</sup>	Vid	+36	V
Input Common-mode Voltage Range	Vicm	(VEE-0.3) to (VEE+36)	V
Operating Supply Voltage	Vopr	+8.0 to +30 (±4.0 to ±15)	V
Operating Temperature Range	Topr	-40 to +105	°C
Storage Temperature Range	Tstg	-55 to +150	°C
Maximum Junction Temperature	Tjmax	+150	°C

Note: Absolute maximum rating item indicates the condition which must not be exceeded.

Application if voltage in excess of absolute maximum rating or use out of absolute maximum rated temperature environment may cause deterioration of characteristics.

\*1 To use at temperature above Ta=25°C reduce 6.2mW/°C.

\*2 To use at temperature above Ta=25°C reduce 5.0mW/°C.

\*3 To use at temperature above Ta=25°C reduce 4.8mW/°C.

\*4 Mounted on a FR4 glass epoxy PCB(70mm×70mm×1.6mm).

\*5 The voltage difference between inverting input and non-inverting input is the differential input voltage. Then input terminal voltage is set to more than VEE.

## ●Electrical Characteristics

OBA4558Yxxx-M (Unless otherwise specified VCC=+15V, VEE=-15V, Full range -40°C to +105°C)

Parameter	Symbol	Temperature Range	Limits			Unit	Condition
			Min.	Typ.	Max.		
Input Offset Voltage *6	Vio	25°C	-	0.5	6	mV	OUT=0V
		Full range	-	-	7		
Input Offset Current *6	Iio	25°C	-	5	200	nA	OUT=0V
		Full range	-	-	200		
Input Bias Current *7	Ib	25°C	-	60	500	nA	OUT=0V
		Full range	-	-	800		
Supply Current	ICC	25°C	-	3	6	mA	RL=∞, All Op-Amps VIN+=0V
		Full range	-	-	6.5		
Maximum Output Voltage	VOM	25°C	±10	±13	-	V	RL ≥ 2kΩ
		Full range	±10	-	-		RL ≥ 10kΩ
		25°C	±12	±14	-		
Large Signal Voltage Gain	Av	25°C	86	100	-	dB	RL ≥ 2kΩ, OUT=±10V Vicm=0V
		Full range	83	-	-		
Input Common-mode Voltage Range	Vicm	25°C	±12	±14	-	V	-
		Full range	±12	-	-		
Common-mode Rejection Ratio	CMRR	25°C	70	90	-	dB	Ri ≤ 10kΩ
Power Supply Rejection Ratio	PSRR	25°C	76.5	90	-	dB	Ri ≤ 10kΩ
Slew Rate	SR	25°C	-	1	-	V/μs	Av=0dB, RL=2kΩ CL=100pF
Unity Gain Frequency	f <sub>T</sub>	25°C	-	2	-	MHz	RL=2kΩ
Total Harmonic Distortion +Noise	THD+N	25°C	-	0.005	-	%	Av=20dB, RL=10kΩ VIN=0.05Vrms, f=1kHz
Input Referred Noise Voltage	Vn	25°C	-	12	-	nV/√Hz	RS=100Ω, Vi=0V, f=1kHz
			-	1.8	-	μVrms	RS=100Ω Vi=0V, DIN-AUDIO
Channel Separation	CS	25°C	-	105	-	dB	R1=100Ω, f=1kHz

\*6 Absolute value

\*7 Current direction: Since first input stage is composed with PNP transistor, input bias current flows out of IC.

### Description of electrical characteristics

Described here are the terms of electric characteristics used in this datasheet. Items and symbols used are also shown. Note that item name and symbol and their meaning may differ from those on another manufacture's document or general document.

#### 1. Absolute maximum ratings

Absolute maximum rating item indicates the condition which must not be exceeded. Application of voltage in excess of absolute maximum rating or use out of absolute maximum rated temperature environment may cause deterioration of characteristics.

##### 1.1 Power supply voltage (VCC-VEE)

Indicates the maximum voltage that can be applied between the positive power supply terminal and negative power supply terminal without deterioration or destruction of characteristics of internal circuit.

##### 1.2 Differential input voltage (V<sub>id</sub>)

Indicates the maximum voltage that can be applied between non-inverting terminal and inverting terminal without deterioration and destruction of characteristics of IC.

##### 1.3 Input common-mode voltage range (V<sub>icm</sub>)

Indicates the maximum voltage that can be applied to non-inverting terminal and inverting terminal without deterioration or destruction of characteristics. Input common-mode voltage range of the maximum ratings not assure normal operation of IC. When normal operation of IC is desired, the input common-mode voltage of characteristics item must be followed.

##### 1.4 Power dissipation (P<sub>d</sub>)

Indicates the power that can be consumed by specified mounted board at the ambient temperature 25°C(normal temperature). As for package product, P<sub>d</sub> is determined by the temperature that can be permitted by IC chip in the package (maximum junction temperature)and thermal resistance of the package.

#### 2. Electrical characteristics item

##### 2.1 Input offset voltage (V<sub>io</sub>)

Indicates the voltage difference between non-inverting terminal and inverting terminal. It can be translated into the input voltage difference required for setting the output voltage at 0V.

##### 2.2 Input offset current (I<sub>io</sub>)

Indicates the difference of input bias current between non-inverting terminal and inverting terminal.

##### 2.3 Input bias current (I<sub>b</sub>)

Indicates the current that flows into or out of the input terminal. It is defined by the average of input bias current at non-inverting terminal and input bias current at inverting terminal.

##### 2.4 Circuit current (I<sub>CC</sub>)

Indicates the IC current that flows under specified conditions and no-load steady status.

##### 2.5 Output saturation voltage (V<sub>OM</sub>)

Signifies the voltage range that can be output under specific output conditions.

##### 2.6 Large signal voltage gain (A<sub>v</sub>)

Indicates the amplifying rate (gain) of output voltage against the voltage difference between non-inverting terminal and Inverting terminal. It is normally the amplifying rate (gain) with reference to DC voltage.

$$A_v = (\text{Output voltage}) / (\text{Differential Input voltage})$$

##### 2.7 Input common-mode voltage range (V<sub>icm</sub>)

Indicates the input voltage range where IC operates normally.

##### 2.8 Common-mode rejection ratio (CMRR)

Indicates the ratio of fluctuation of input offset voltage when in-phase input voltage is changed. It is normally the fluctuation of DC.

$$\text{CMRR} = (\text{Change of Input common-mode voltage})/(\text{Input offset fluctuation})$$

##### 2.9 Power supply rejection ratio (PSRR)

Indicates the ratio of fluctuation of input offset voltage when supply voltage is changed. It is normally the fluctuation of DC.

$$\text{PSRR} = (\text{Change of power supply voltage}) / (\text{Input offset fluctuation})$$

##### 2.10 Slew Rate (SR)

SR is a parameter that shows movement speed of operational amplifier. It indicates rate of variable output voltage as unit time.

##### 2.11 Unity gain frequency (f<sub>r</sub>)

Indicates a frequency where the voltage gain of operational amplifier is 1.

##### 2.12 Total harmonic distortion + Noise (THD+N)

Indicates the fluctuation of input offset voltage or that of output voltage with reference to the change of output voltage of driven channel.

##### 2.13 Input referred noise voltage (V<sub>n</sub>)

Indicates a noise voltage generated inside the operational amplifier equivalent by ideal voltage source connected in series with input terminal.

##### 2.14 Channel separation (CS)

Indicates the fluctuation of input offset voltage or that of output voltage with reference to the change of output voltage of driven channel.

● Typical Performance Curves

OBA4558Yxxx-M

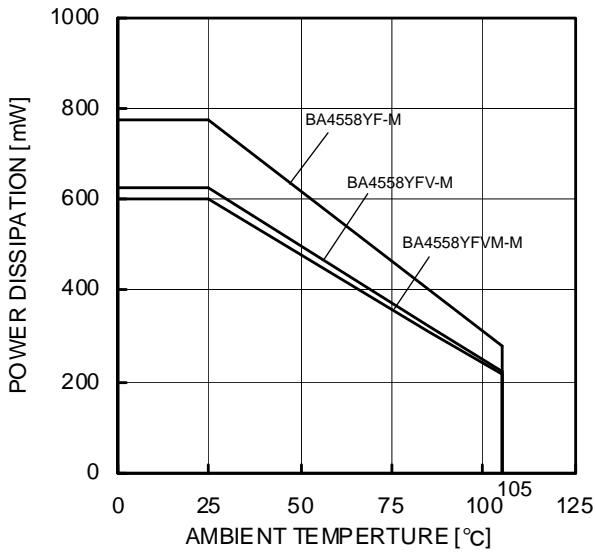

Figure 2.  
Derating Curve

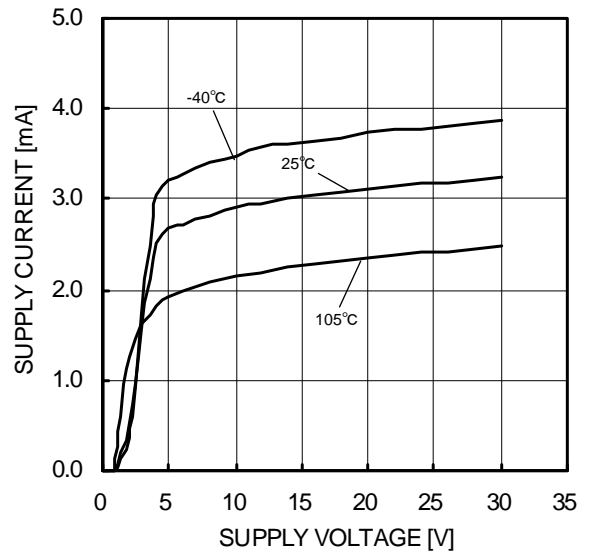

Figure 3.  
Supply Current - Supply Voltage

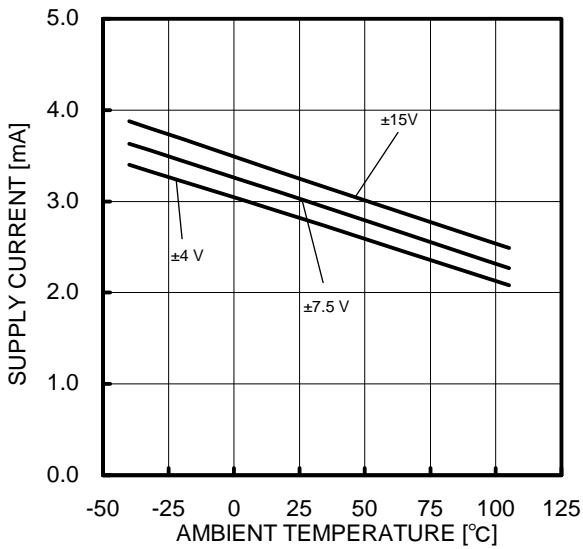

Figure 4.  
Supply Current - Ambient Temperature

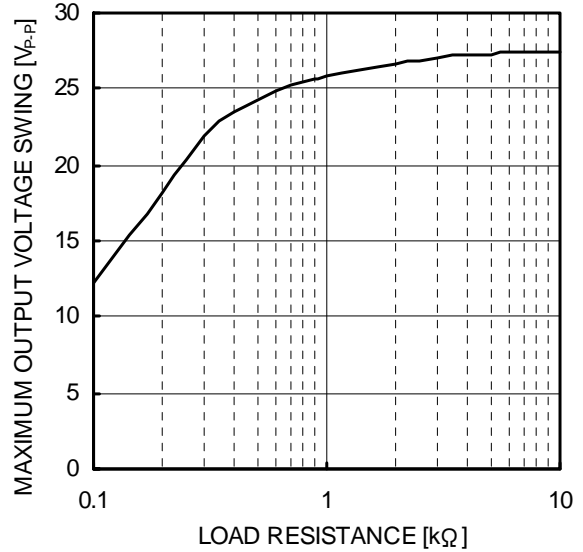

Figure 5.  
Maximum Output Voltage Swing  
- Load Resistance  
(VCC/VEE=+15V/-15V, Ta=25°C)

(\*) The above data is measurement value of typical sample, it is not guaranteed.

OBA4558Yxxx-M

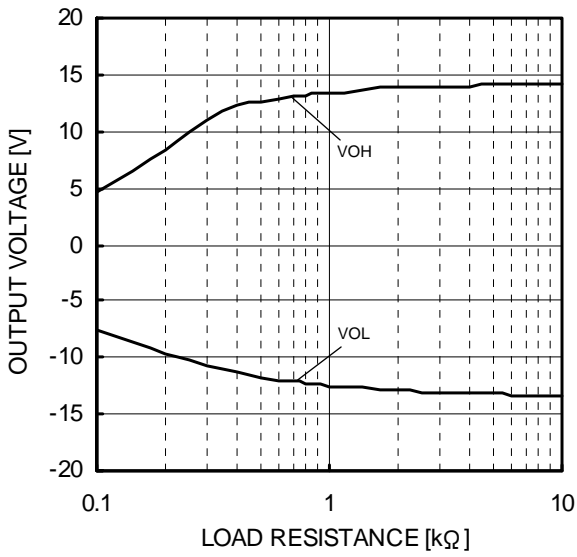

Figure 6.  
Maximum Output Voltage  
- Load Resistance  
(VCC/VEE=+15V/-15V, Ta=25°C)

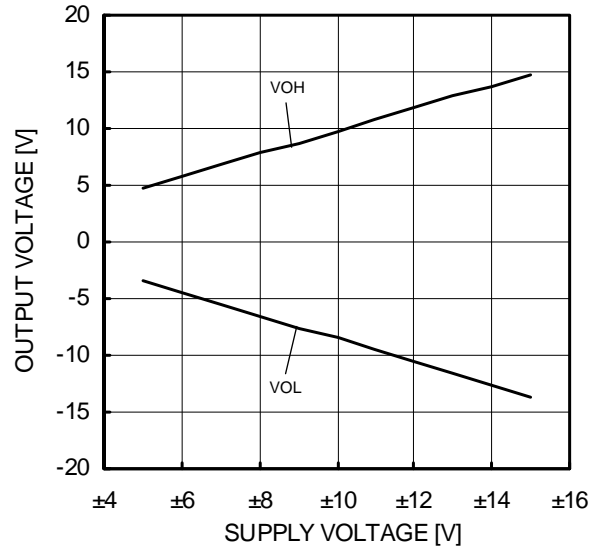

Figure 7.  
Maximum Output Voltage  
- Supply Voltage  
(RL=2kΩ, Ta=25°C)

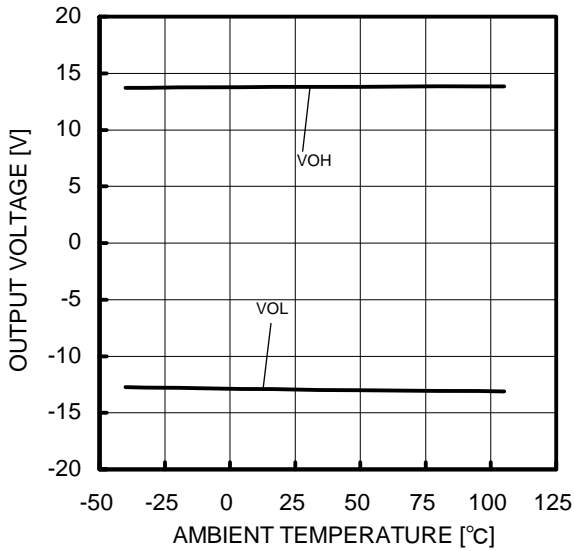

Figure 8.  
Maximum Output Voltage  
- Ambient Temperature  
(VCC/VEE=+15V/-15V, RL=2kΩ)

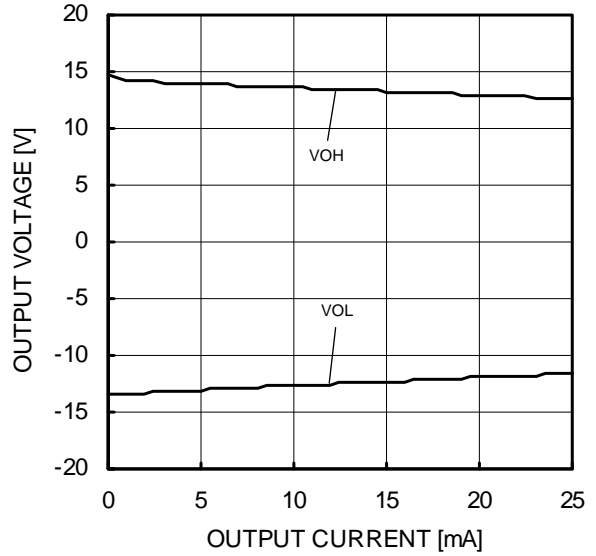

Figure 9.  
Maximum Output Voltage  
- Output Current  
(VCC/VEE=+15V/-15V, Ta=25°C)

(\*) The above data is measurement value of typical sample, it is not guaranteed.

OBA4558Yxxx-M

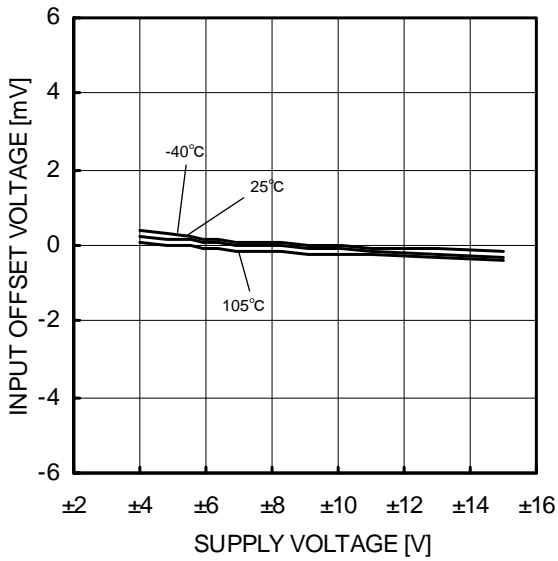

Figure 10.  
Input Offset Voltage - Supply Voltage  
( $V_{icm}=0V$ ,  $OUT=0V$ )

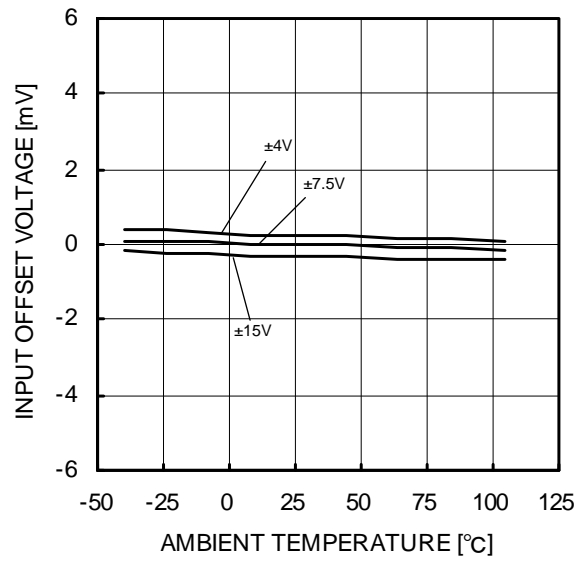

Figure 11.  
Input Offset Voltage - Ambient Temperature  
( $V_{icm}=0V$ ,  $OUT=0V$ )

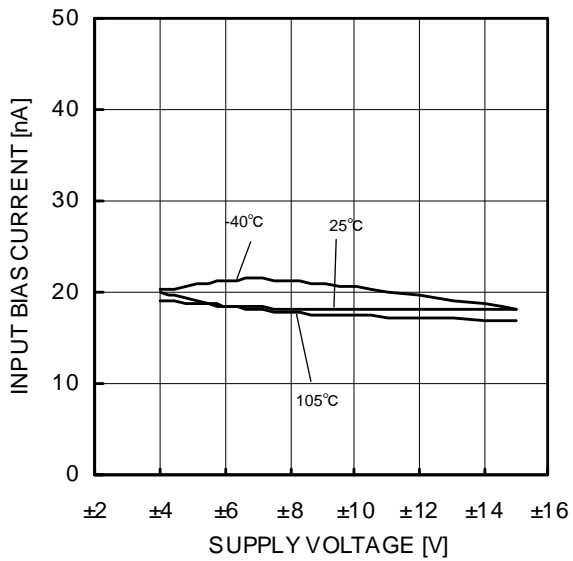

Figure 12.  
Input Bias Current - Supply Voltage  
( $V_{icm}=0V$ ,  $OUT=0V$ )

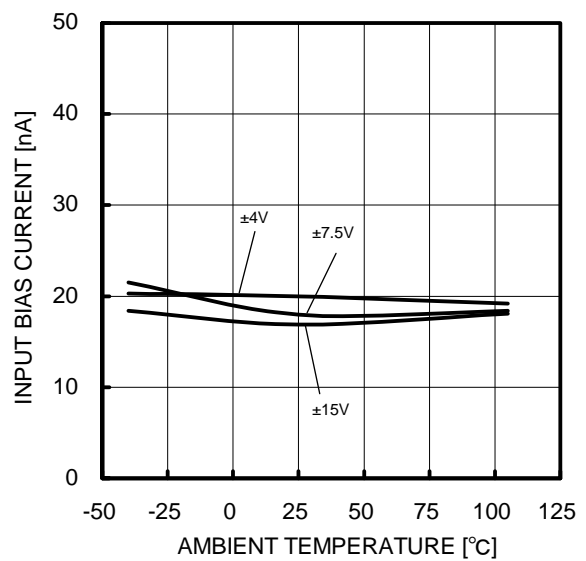

Figure 13.  
Input Bias Current - Ambient Temperature  
( $V_{icm}=0V$ ,  $OUT=0V$ )

(\*) The above data is measurement value of typical sample, it is not guaranteed.

OBA4558Yxxx-M

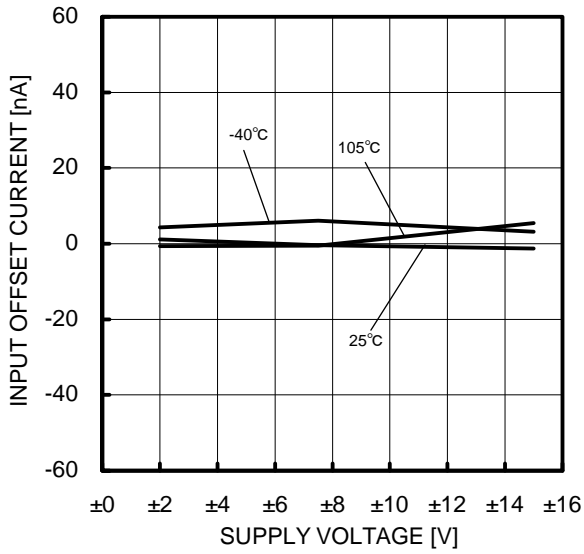

Figure 14.  
Input Offset Current - Supply Voltage  
(Vicm=0V, OUT=0V)

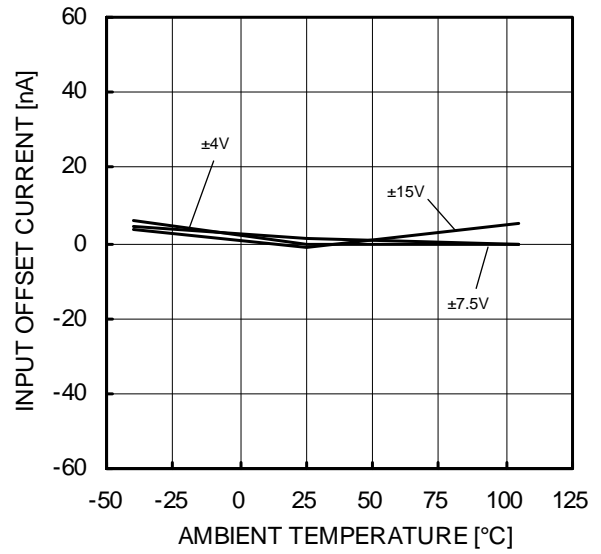

Figure 15.  
Input Offset Current - Ambient Temperature  
(Vicm=0V, OUT=0V)

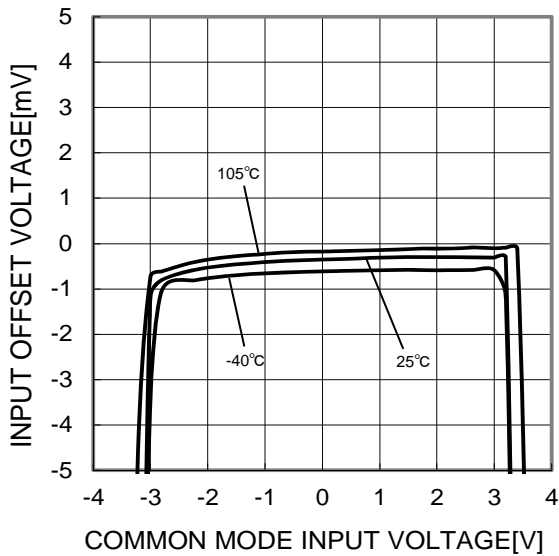

Figure 16.  
Input Offset Voltage  
- Common Mode Input Voltage  
(VCC=4V, VEE=-4V, OUT=0V)

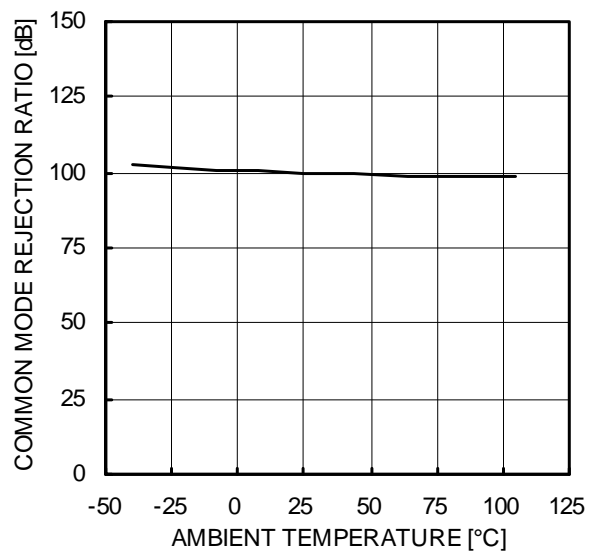

Figure 17.  
Common Mode Rejection Ratio  
- Ambient Temperature  
(VCC/VEE=+15V/-15V, Vicm=-12V to +12V)

(\*) The above data is measurement value of typical sample, it is not guaranteed.

OBA4558Yxxx-M

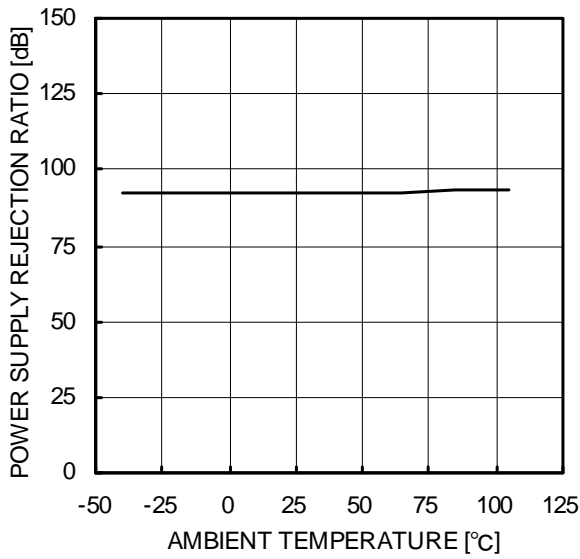

Figure 18.  
Power Supply Rejection Ratio  
- Ambient Temperature  
(VCC/VEE=+4V/-4V to +15V/-15V)

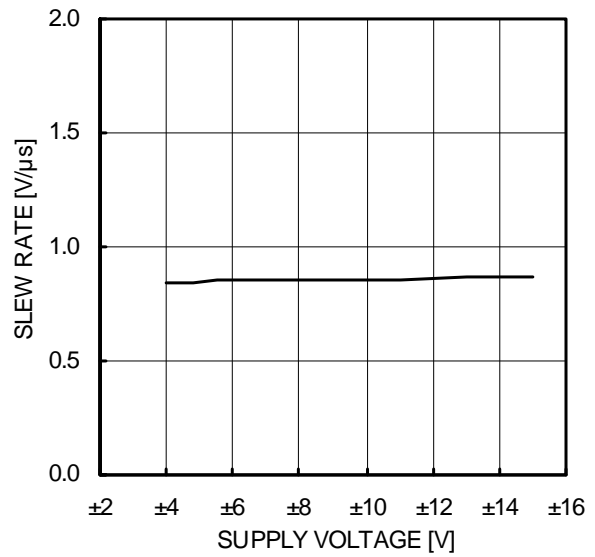

Figure 19.  
Slew Rate - Supply Voltage  
(CL=100pF, RL=2kΩ, Ta=25°C)

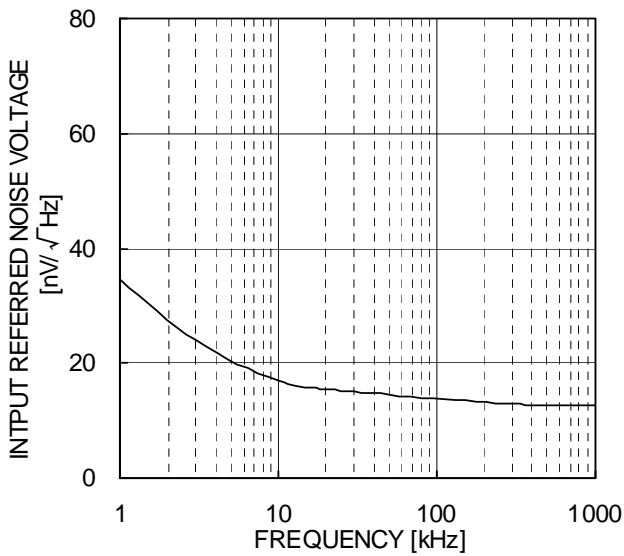

Figure 20.  
Equivalent Input Noise Voltage - Frequency  
(VCC/VEE=+15V/-15V, RS=100Ω, Ta=25°C)

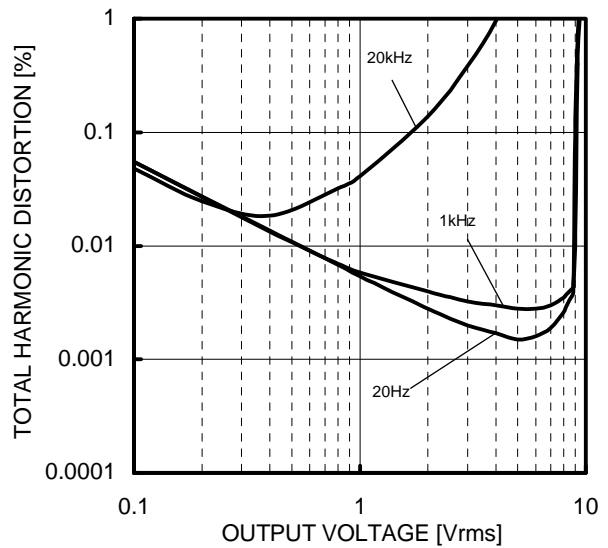

Figure 21.  
Total Harmonic Distortion - Output Voltage  
(VCC/VEE=+15V/-15V, Av=20dB, RL=2kΩ, 80kHz-LPF, Ta=25°C)

(\*) The above data is measurement value of typical sample, it is not guaranteed.

OBA4558Yxxx-M

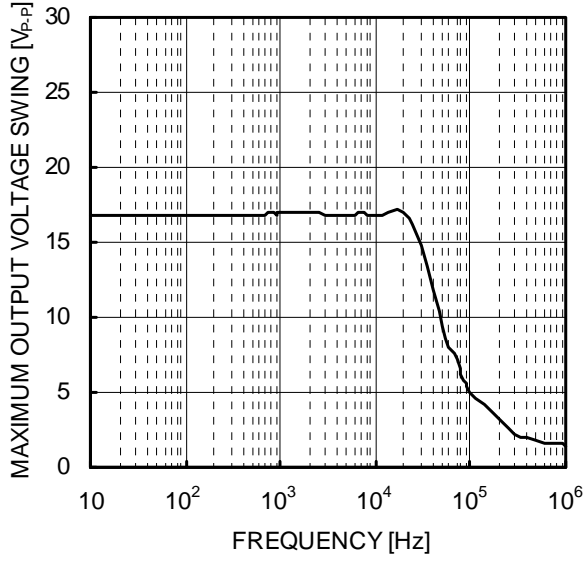

Figure 22.  
Maximum Output Voltage Swing – Frequency  
(VCC/VEE=+15V/-15V, RL=2kΩ, Ta=25°C)

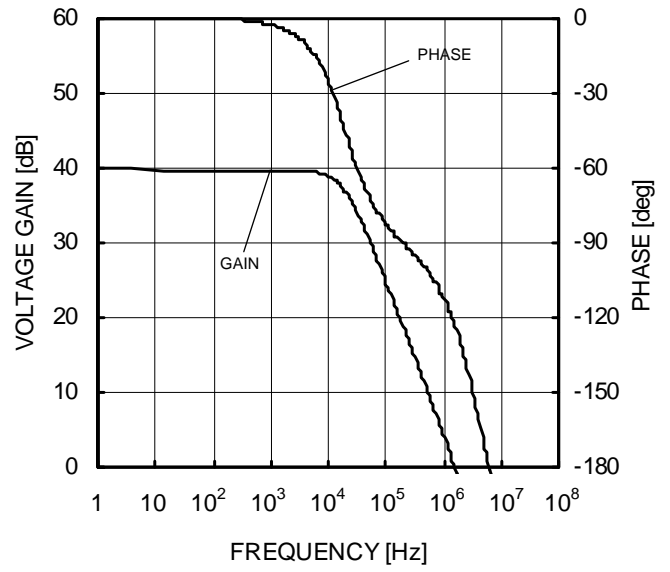

Figure 23.  
Voltage Gain, Phase - Frequency  
(VCC/VEE=+15V/-15V, Av=40dB, RL=2kΩ, Ta=25°C)

(\*) The above data is measurement value of typical sample, it is not guaranteed.

● Power Dissipation

Power dissipation (total loss) indicates the power that the IC can consume at Ta=25°C (normal temperature). As the IC consumes power, it heats up, causing its temperature to be higher than the ambient temperature. The allowable temperature that the IC can accept is limited. This depends on the circuit configuration, manufacturing process, and consumable power.

Power dissipation is determined by the allowable temperature within the IC (maximum junction temperature) and the thermal resistance of the package used (heat dissipation capability). Maximum junction temperature is typically equal to the maximum storage temperature. The heat generated through the consumption of power by the IC radiates from the mold resin or lead frame of the package. Thermal resistance, represented by the symbol θja°C/W, indicates this heat dissipation capability. Similarly, the temperature of an IC inside its package can be estimated by thermal resistance.

Figure 24. (a) shows the model of the thermal resistance of the package. The equation below shows how to compute for the Thermal resistance (θja), given the ambient temperature (Ta), maximum junction temperature (Tjmax), and power dissipation (Pd).

$$\theta_{ja} = (T_{jmax} - T_a) / P_d \quad \text{°C/W} \quad \dots \dots \dots (I)$$

The Derating curve in Figure 24. (b) indicates the power that the IC can consume with reference to ambient temperature. Power consumption of the IC begins to attenuate at certain temperatures. This gradient is determined by Thermal resistance (θja), which depends on the chip size, power consumption, package, ambient temperature, package condition, wind velocity, etc. This may also vary even when the same of package is used. Thermal reduction curve indicates a reference value measured at a specified condition. Figure 25. (c) shows an example of the derating curve for BA4558Yxxx-M.

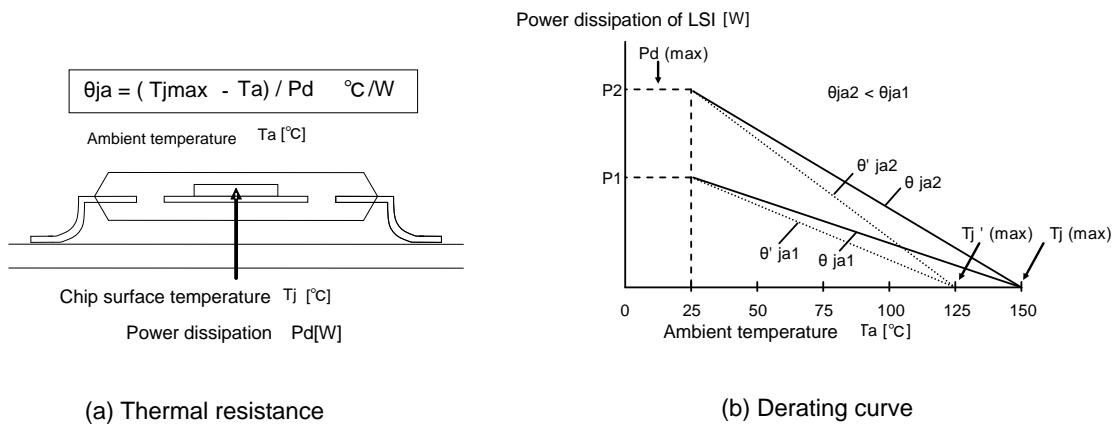
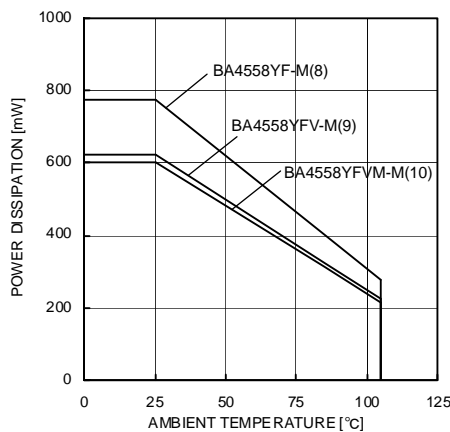

Figure 24. Thermal resistance and derating



(c) BA4558Yxxx-M

( 8 )	( 9 )	( 10 )	Unit
6.2	5.0	4.8	mW/°C

When using the unit above Ta=25°C, subtract the value above per Celsius degree .  
 Mounted on a FR4 glass epoxy board 70mmx70mmx1.6mm(cooper foil area below 3%)

Figure 25. Derating curve

●Application Information

NULL method condition for Test circuit1

VCC, VEE, EK, Vicm Unit: V

Parameter	VF	S1	S2	S3	VCC	VEE	EK	Vicm	calculation
Input Offset Voltage	VF1	ON	ON	OFF	15	-15	0	0	1
Input Offset Current	VF2	OFF	OFF	OFF	15	-15	0	0	2
Input Bias Current	VF3	OFF	ON	OFF	15	-15	0	0	3
	VF4	ON	OFF						
Large Signal Voltage Gain	VF5	ON	ON	ON	15	-15	0	0	4
	VF6				15	-15	0	0	
Common-mode Rejection Ratio (Input common-mode Voltage Range)	VF7	ON	ON	OFF	3	-27	0	0	5
	VF8				27	-3	0	0	
Power Supply Rejection Ratio	VF9	ON	ON	OFF	4	-4	0	0	6
	VF10				15	-15	0	0	

- Calculation -

1. Input Offset Voltage (Vio)

$$V_{io} = \frac{|VF1|}{1+RF/RS} \text{ [V]}$$

2. Input Offset Current (Iio)

$$I_{io} = \frac{|VF2 - VF1|}{R_i \times (1+RF/RS)} \text{ [A]}$$

3. Input Bias Current (Ib)

$$I_b = \frac{|VF4 - VF3|}{2 \times R_i \times (1+RF/RS)} \text{ [A]}$$

4. Large Signal Voltage Gain (Av)

$$A_v = 20 \times \text{Log} \frac{\Delta EK \times (1+RF/RS)}{|VF5 - VF6|} \text{ [dB]}$$

5. Common-mode Rejection Ration (CMRR)

$$CMRR = 20 \times \text{Log} \frac{\Delta Vicm \times (1+RF/RS)}{|VF8 - VF7|} \text{ [dB]}$$

6. Power supply rejection ratio (PSRR)

$$PSRR = 20 \times \text{Log} \frac{\Delta V_{cc} \times (1+RF/RS)}{|VF10 - VF9|} \text{ [dB]}$$

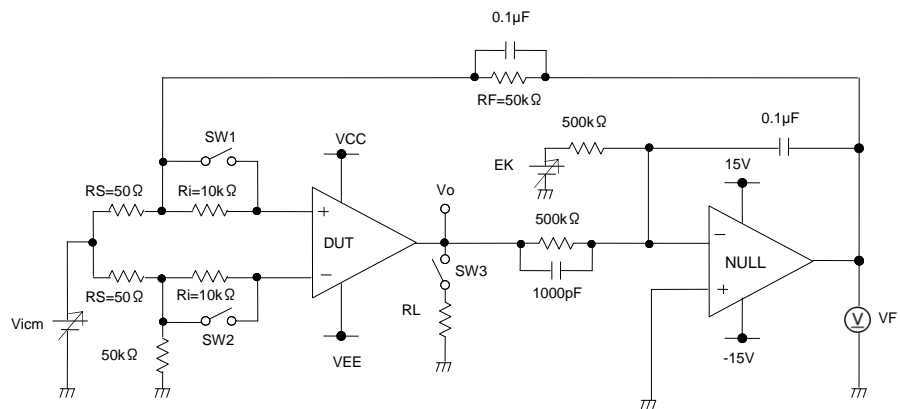

Figure 26. Test circuit1 (one channel only)

Switch Condition for Test Circuit 2

SW No.	SW 1	SW 2	SW 3	SW 4	SW 5	SW 6	SW 7	SW 8	SW 9	SW 10	SW 11	SW 12	SW 13	SW 14
Supply Current	OFF	OFF	OFF	ON	OFF	ON	OFF	OFF	OFF	OFF	OFF	OFF	OFF	OFF
Maximum Output Voltage (high)	OFF	OFF	ON	OFF	OFF	ON	OFF	OFF	ON	OFF	OFF	OFF	ON	OFF
Maximum Output Voltage (Low)	OFF	OFF	ON	OFF	OFF	ON	OFF	OFF	ON	OFF	OFF	OFF	ON	OFF
Output Source Current	OFF	OFF	ON	OFF	OFF	ON	OFF	OFF	OFF	OFF	OFF	OFF	OFF	ON
Output Sink Current	OFF	OFF	ON	OFF	OFF	ON	OFF	OFF	OFF	OFF	OFF	OFF	OFF	ON
Slew Rate	OFF	OFF	OFF	ON	OFF	OFF	OFF	ON	ON	ON	ON	OFF	OFF	OFF
Gain Bandwidth Product	OFF	ON	OFF	OFF	ON	ON	OFF	OFF	ON	ON	ON	OFF	OFF	OFF
Equivalent Input Noise Voltage	ON	OFF	OFF	OFF	ON	ON	OFF	OFF	OFF	OFF	ON	OFF	OFF	OFF

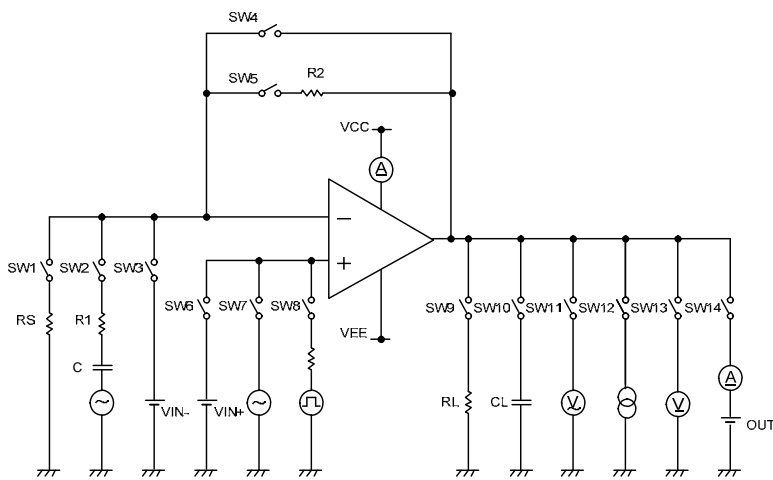

Figure 27. Test Circuit 2 (each Op-Amp)

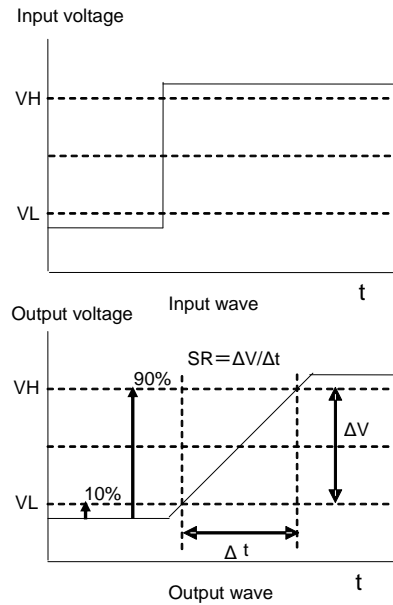

Figure 28. Slew Rate Input Waveform

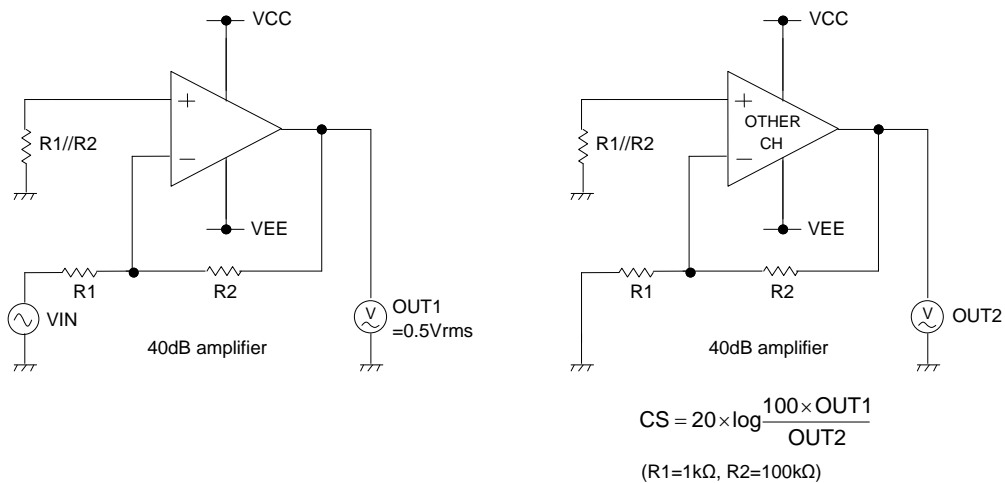

Figure 29. Test Circuit 3(Channel Separation)

### ●Operational Notes

- 1) Processing of unused circuit  
It is recommended to apply connection (see the Figure 30.) and set the non inverting input terminal at the potential within input common-mode voltage range ( $V_{icm}$ ), for any unused circuit.
- 2) Input voltage  
Applying  $(V_{EE} - 0.3)$  to  $(V_{EE} + 36)V$  (BA4558R) to the input terminal is possible without causing deterioration of the electrical characteristics or destruction, irrespective of the supply voltage. However, this does not ensure normal circuit operation. Please note that the circuit operates normally only when the input voltage is within the common mode input voltage range of the electric characteristics.
- 3) Maximum output voltage  
Because the output voltage range becomes narrow as the output current increases, design the application with margin by considering changes in electrical characteristics and temperature characteristics.
- 4) Short-circuit of output terminal  
When output terminal and VCC or VEE terminal are shorted, excessive Output current may flow under some conditions, and heating may destroy IC. It is necessary to connect a resistor as shown in Figure 31., thereby protecting against load shorting.
- 5) Power supply (split supply / single supply) in used  
Op-amp operates when specified voltage is applied between VCC and VEE. Therefore, the single supply Op-Amp can be used for double supply Op-Amp as well.
- 6) Power dissipation ( $P_d$ )  
Use a thermal design that allows for a sufficient margin in light of the power dissipation ( $P_d$ ) in actual operating conditions.
- 7) Short-circuit between pins and wrong mounting  
Pay attention to the assembly direction of the ICs. Wrong mounting direction or shorts between terminals, GND, or other components on the circuits, can damage the IC.
- 8) Use in strong electromagnetic field  
Using the ICs in strong electromagnetic field can cause operation malfunction.
- 9) Radiation  
This IC is not designed to be radiation-resistant.
- 10) IC Handling  
When stress is applied to IC because of deflection or bend of board, the characteristics may fluctuate due to piezo resistance effects.
- 11) Inspection on set board  
During testing, turn on or off the power before mounting or dismounting the board from the test Jig. Do not power up the board without waiting for the output capacitors to discharge. The capacitors in the low output impedance terminal can stress the device. Pay attention to the electro static voltages during IC handling, transportation, and storage.
- 12) Output capacitor  
When VCC terminal is shorted to VEE (GND) potential and an electric charge has accumulated on the external capacitor, connected to output terminal, accumulated charge may be discharged VCC terminal via the parasitic element within the circuit or terminal protection element. The element in the circuit may be damaged (thermal destruction). When using this IC for an application circuit where there is oscillation, output capacitor load does not occur, as when using this IC as a voltage comparator. Set the capacitor connected to output terminal below  $0.1\mu F$  in order to prevent damage to IC.

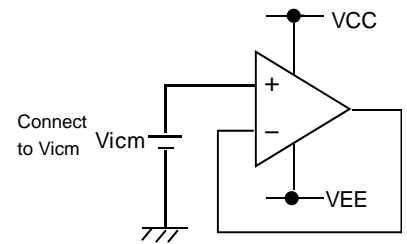

Figure 30. The example of application circuit for unused op-amp

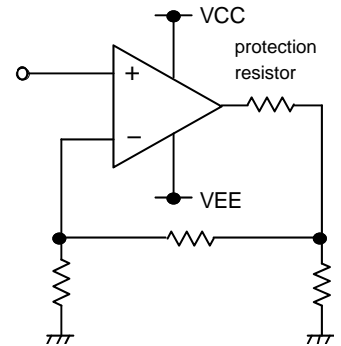
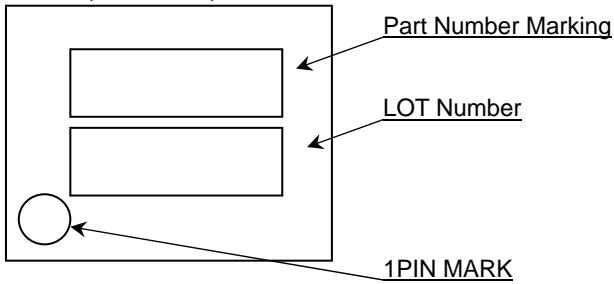

Figure 31. The example of output short protection



●Marking Diagram

SOP8(TOP VIEW)



SSOP-B8(TOP VIEW)

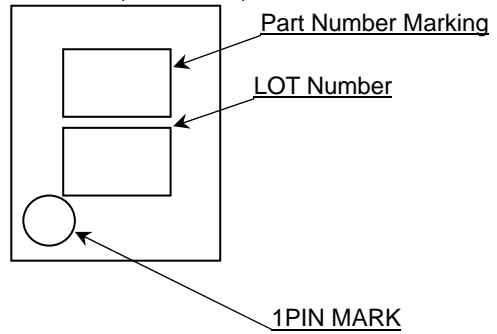

MSOP8(TOP VIEW)

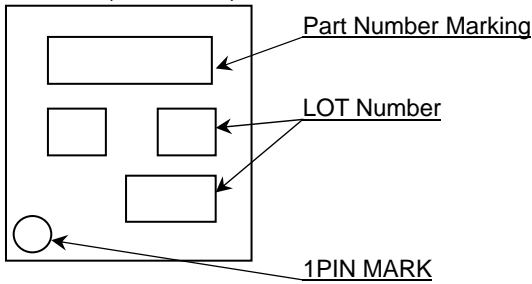

Product Name		Package Type	Marking
BA4558Y	F-M	SOP8	58YM
	FV-M	SSOP-B8	58YM
	FVM-M	MSOP8	58YM

●Land pattern data

SOP8, SSOP-B8, MSOP8

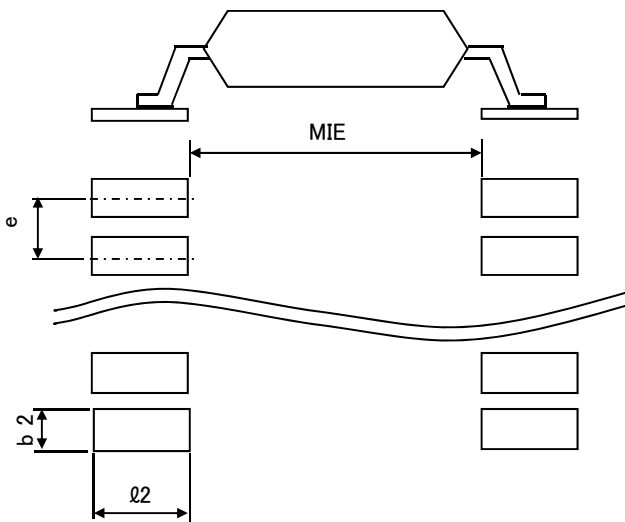

All dimensions in mm

PKG	Land pitch e	Land space MIE	Land length $\geq l2$	Land width b2
SOP8	1.27	4.60	1.10	0.76
SSOP-B8	0.65	4.60	1.20	0.35
MSOP8	0.65	2.62	0.99	0.35

●Revision History

Date	Revision	Changes
20.Feb.2013	001	New Release

# Notice

## Precaution on using ROHM Products

1. If you intend to use our Products in devices requiring extremely high reliability (such as medical equipment <sup>(Note 1)</sup>, aircraft/spacecraft, nuclear power controllers, etc.) and whose malfunction or failure may cause loss of human life, bodily injury or serious damage to property ("Specific Applications"), please consult with the ROHM sales representative in advance. Unless otherwise agreed in writing by ROHM in advance, ROHM shall not be in any way responsible or liable for any damages, expenses or losses incurred by you or third parties arising from the use of any ROHM's Products for Specific Applications.

(Note1) Medical Equipment Classification of the Specific Applications

JAPAN	USA	EU	CHINA
CLASS III	CLASS III	CLASS II b	CLASS III
CLASS IV		CLASS III	

2. ROHM designs and manufactures its Products subject to strict quality control system. However, semiconductor products can fail or malfunction at a certain rate. Please be sure to implement, at your own responsibilities, adequate safety measures including but not limited to fail-safe design against the physical injury, damage to any property, which a failure or malfunction of our Products may cause. The following are examples of safety measures:
  - [a] Installation of protection circuits or other protective devices to improve system safety
  - [b] Installation of redundant circuits to reduce the impact of single or multiple circuit failure
3. Our Products are not designed under any special or extraordinary environments or conditions, as exemplified below. Accordingly, ROHM shall not be in any way responsible or liable for any damages, expenses or losses arising from the use of any ROHM's Products under any special or extraordinary environments or conditions. If you intend to use our Products under any special or extraordinary environments or conditions (as exemplified below), your independent verification and confirmation of product performance, reliability, etc. prior to use, must be necessary:
  - [a] Use of our Products in any types of liquid, including water, oils, chemicals, and organic solvents
  - [b] Use of our Products outdoors or in places where the Products are exposed to direct sunlight or dust
  - [c] Use of our Products in places where the Products are exposed to sea wind or corrosive gases, including Cl<sub>2</sub>, H<sub>2</sub>S, NH<sub>3</sub>, SO<sub>2</sub>, and NO<sub>2</sub>
  - [d] Use of our Products in places where the Products are exposed to static electricity or electromagnetic waves
  - [e] Use of our Products in proximity to heat-producing components, plastic cords, or other flammable items
  - [f] Sealing or coating our Products with resin or other coating materials
  - [g] Use of our Products without cleaning residue of flux (even if you use no-clean type fluxes, cleaning residue of flux is recommended); or Washing our Products by using water or water-soluble cleaning agents for cleaning residue after soldering
  - [h] Use of the Products in places subject to dew condensation
4. The Products are not subject to radiation-proof design.
5. Please verify and confirm characteristics of the final or mounted products in using the Products.
6. In particular, if a transient load (a large amount of load applied in a short period of time, such as pulse. is applied, confirmation of performance characteristics after on-board mounting is strongly recommended. Avoid applying power exceeding normal rated power; exceeding the power rating under steady-state loading condition may negatively affect product performance and reliability.
7. De-rate Power Dissipation (Pd) depending on Ambient temperature (Ta). When used in sealed area, confirm the actual ambient temperature.
8. Confirm that operation temperature is within the specified range described in the product specification.
9. ROHM shall not be in any way responsible or liable for failure induced under deviant condition from what is defined in this document.

## Precaution for Mounting / Circuit board design

1. When a highly active halogenous (chlorine, bromine, etc.) flux is used, the residue of flux may negatively affect product performance and reliability.
2. In principle, the reflow soldering method must be used; if flow soldering method is preferred, please consult with the ROHM representative in advance.

For details, please refer to ROHM Mounting specification

**Precautions Regarding Application Examples and External Circuits**

1. If change is made to the constant of an external circuit, please allow a sufficient margin considering variations of the characteristics of the Products and external components, including transient characteristics, as well as static characteristics.
2. You agree that application notes, reference designs, and associated data and information contained in this document are presented only as guidance for Products use. Therefore, in case you use such information, you are solely responsible for it and you must exercise your own independent verification and judgment in the use of such information contained in this document. ROHM shall not be in any way responsible or liable for any damages, expenses or losses incurred by you or third parties arising from the use of such information.

**Precaution for Electrostatic**

This Product is electrostatic sensitive product, which may be damaged due to electrostatic discharge. Please take proper caution in your manufacturing process and storage so that voltage exceeding the Products maximum rating will not be applied to Products. Please take special care under dry condition (e.g. Grounding of human body / equipment / solder iron, isolation from charged objects, setting of ionizer, friction prevention and temperature / humidity control).

**Precaution for Storage / Transportation**

1. Product performance and soldered connections may deteriorate if the Products are stored in the places where:
  - [a] the Products are exposed to sea winds or corrosive gases, including Cl<sub>2</sub>, H<sub>2</sub>S, NH<sub>3</sub>, SO<sub>2</sub>, and NO<sub>2</sub>
  - [b] the temperature or humidity exceeds those recommended by ROHM
  - [c] the Products are exposed to direct sunshine or condensation
  - [d] the Products are exposed to high Electrostatic
2. Even under ROHM recommended storage condition, solderability of products out of recommended storage time period may be degraded. It is strongly recommended to confirm solderability before using Products of which storage time is exceeding the recommended storage time period.
3. Store / transport cartons in the correct direction, which is indicated on a carton with a symbol. Otherwise bent leads may occur due to excessive stress applied when dropping of a carton.
4. Use Products within the specified time after opening a humidity barrier bag. Baking is required before using Products of which storage time is exceeding the recommended storage time period.

**Precaution for Product Label**

QR code printed on ROHM Products label is for ROHM's internal use only.

**Precaution for Disposition**

When disposing Products please dispose them properly using an authorized industry waste company.

**Precaution for Foreign Exchange and Foreign Trade act**

Since our Products might fall under controlled goods prescribed by the applicable foreign exchange and foreign trade act, please consult with ROHM representative in case of export.

**Precaution Regarding Intellectual Property Rights**

1. All information and data including but not limited to application example contained in this document is for reference only. ROHM does not warrant that foregoing information or data will not infringe any intellectual property rights or any other rights of any third party regarding such information or data. ROHM shall not be in any way responsible or liable for infringement of any intellectual property rights or other damages arising from use of such information or data.:
2. No license, expressly or implied, is granted hereby under any intellectual property rights or other rights of ROHM or any third parties with respect to the information contained in this document.

**Other Precaution**



1. This document may not be reprinted or reproduced, in whole or in part, without prior written consent of ROHM.
2. The Products may not be disassembled, converted, modified, reproduced or otherwise changed without prior written consent of ROHM.
3. In no event shall you use in any way whatsoever the Products and the related technical information contained in the Products or this document for any military purposes, including but not limited to, the development of mass-destruction weapons.
4. The proper names of companies or products described in this document are trademarks or registered trademarks of ROHM, its affiliated companies or third parties.

**General Precaution**





1. Before you use our Products, you are requested to carefully read this document and fully understand its contents. ROHM shall not be in any way responsible or liable for failure, malfunction or accident arising from the use of any ROHM's Products against warning, caution or note contained in this document.
2. All information contained in this document is current as of the issuing date and subject to change without any prior notice. Before purchasing or using ROHM's Products, please confirm the latest information with a ROHM sales representative.
3. The information contained in this document is provided on an "as is" basis and ROHM does not warrant that all information contained in this document is accurate and/or error-free. ROHM shall not be in any way responsible or liable for any damages, expenses or losses incurred by you or third parties resulting from inaccuracy or errors of or concerning such information.

## Looking for pricing, stock, or lifecycle information?

Click below to explore more details on WIN SOURCE:

-  [View BA4558YFV-MGE2 on WIN SOURCE](#)
-  [Rohm Semiconductor](#) Information

## Optimize Your Supply Chain with WIN SOURCE Solutions

-  Global Sourcing Solution
-  Obsolete Management
-  Cost Control Management
-  Shortage Management
-  Alternative Solution
-  Excess Inventory Management