



**THE DATASHEET OF
AP2822CKATR-G1**



Description

The AP2822 is an integrated high-side power switch that consists of N-Channel MOSFET, charge pump, over current & temperature and other related protection circuits. The switch's low $R_{DS(ON)}$, 85m Ω is designed to meet USB voltage drop requirements. The IC includes soft-start to limit inrush current, over-current protection, load short protection with fold-back, and thermal shutdown to avoid switch failure during hot plug-in. Under voltage lockout (UVLO) function is used to ensure the device remain off unless there is a valid input voltage present. A FLAG output is available to indicate fault conditions to the local USB controller.

The AP2822 is available in the standard package of SOT-23-5.

Features

- Low MOSFET On Resistance: 85m Ω
- Compliant to USB Specifications
- Available 4 Versions of Continuous Load: 0.5A/1.0A/1.5A/2.0A
- Logic Level Enable Pin: Available with Active-high or Active-low Version
- Operating Voltage Range: 2.7V to 5.5V
- Low Supply Current: 68 μ A (Typ.)
- Low Shutdown Current: 1.0 μ A (Max)
- Under-voltage Lockout
- Soft Start-up
- Over-current Protection
- Over Temperature Protection
- Load Short Protection with Fold-back
- No Reverse Current When Power Off
- Deglitched FLAG Output with Open Drain
- With Output Shutdown Pull-low Resistor (For Auto-discharge)
(AP2822A/AP2822B/AP2822C/AP2822D/AP2822E/AP2822F/AP2822G/AP2822H)
- Without Output Shutdown Pull-low Resistor (For No Auto-discharge)
(AP2822AN/AP2822BN/AP2822CN/AP2822DN/AP2822EN/AP2822FN/AP2822GN/AP2822HN)
- **Totally Lead-free & Fully RoHS Compliant (Notes 1 & 2)**
- **Halogen and Antimony Free. "Green" Device (Note 3)**

Notes:

1. No purposely added lead. Fully EU Directive 2002/95/EC (RoHS), 2011/65/EU (RoHS 2) & 2015/863/EU (RoHS 3) compliant.
2. See <https://www.diodes.com/quality/lead-free/> for more information about Diodes Incorporated's definitions of Halogen- and Antimony-free, "Green" and Lead-free.
3. Halogen- and Antimony-free "Green" products are defined as those which contain <900ppm bromine, <900ppm chlorine (<1500ppm total Br + Cl) and <1000ppm antimony compounds.

Pin Assignments

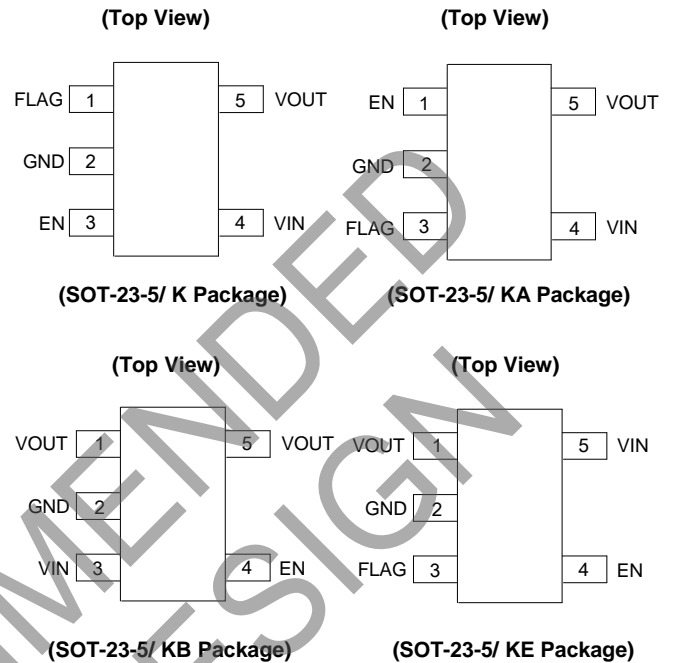

Applications

- USB Power Management
- USB Bus/Self Powered Hubs
- Hot-plug Power Supplies
- Battery-charger Circuits
- Notebooks, Motherboard PCs

Typical Applications Circuit

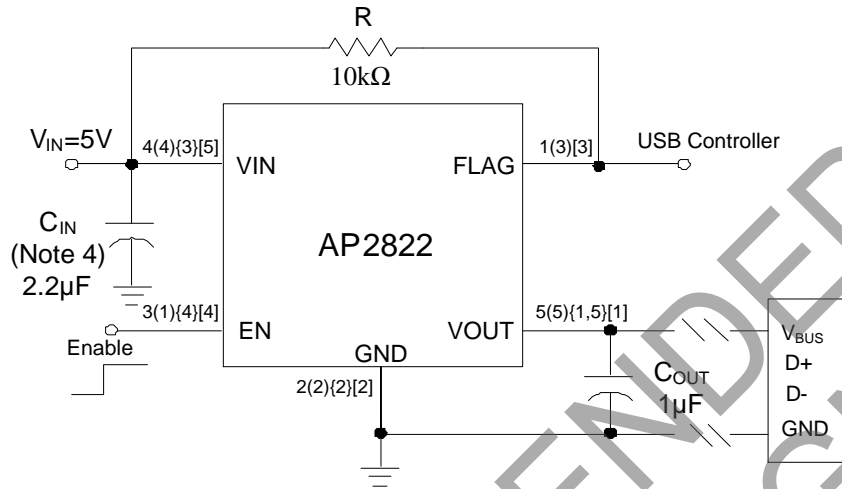

- A(B){C}[D]
 A: SOT-23-5(K Package)
 B: SOT-23-5(KA Package)
 C: SOT-23-5(KB Package)
 D: SOT-23-5(KE Package)

Note 4: 2.2µF input capacitor is enough in most application cases. If the VOUT is short to ground frequently during usage, large size input capacitor is necessary, recommend 22µF.

Pin Descriptions

Pin Number	Pin Name	Function
1(K)	FLAG	Fault flag pin, output with open drain, need a pull-up resistor in application, active low to indicate OCP or OTP
3(KA/KE)		
2	GND	Ground
3(K)	EN	Chip enable control input, active low or high
1(KA)		
4(KB/KE)		
4(K/KA)	VIN	Supply input pin
3(KB)		
5(KE)		
5(K/KA)	VOUT	Switch output voltage
1,5(KB)		
1(KE)		

Functional Block Diagram

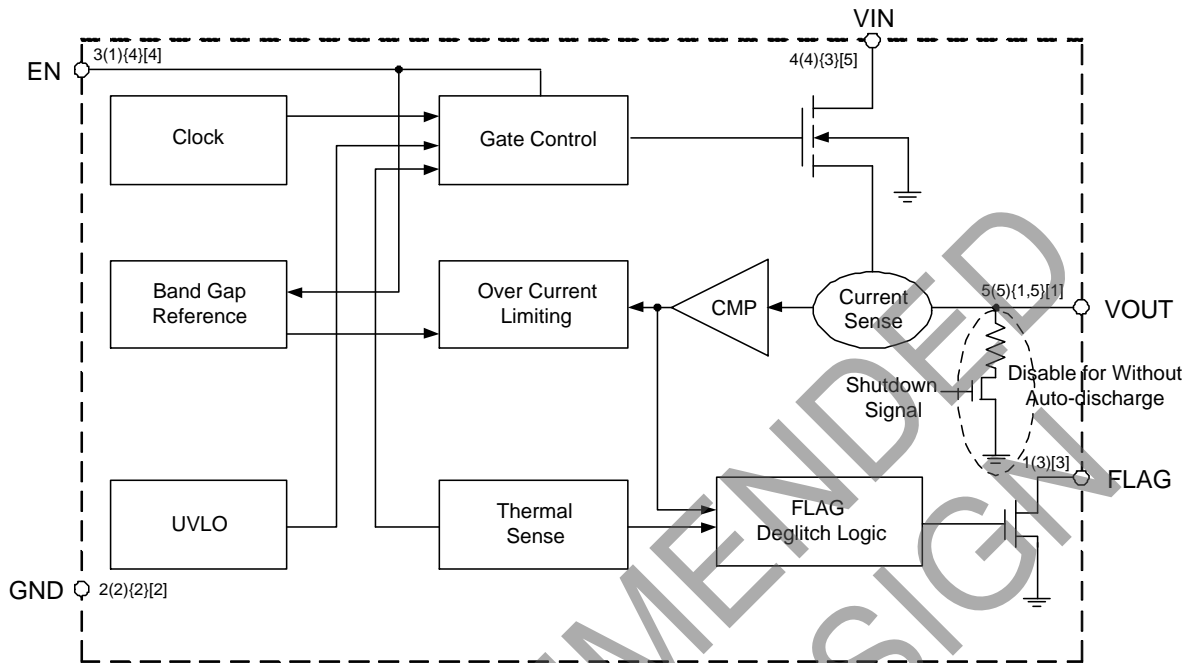

- A(B){C}{D]
 A: SOT-23-5(K Package)
 B: SOT-23-5(KA Package)
 C: SOT-23-5(KB Package)
 D: SOT-23-5(KE Package)

NOT RECOMMENDED FOR NEW DESIGN

Absolute Maximum Ratings (Note 5)

Symbol	Parameter	Rating	Unit
V _{IN}	Power Supply Voltage	6.0	V
T _J	Operating Junction Temperature Range	+150	°C
T _{STG}	Storage Temperature Range	-65 to +150	°C
T _{LEAD}	Lead Temperature (Soldering, 10sec)	+260	°C
θ _{JA}	Thermal Resistance (Junction to Ambient)	200	°C/W
—	ESD (Machine Model)	200	V
—	ESD (Human Body Model)	2000	V

Note 5: Stresses greater than those listed under “Absolute Maximum Ratings” may cause permanent damage to the device. These are stress ratings only, and functional operation of the device at these or any other conditions beyond those indicated under “Recommended Operating Conditions” is not implied. Exposure to “Absolute Maximum Ratings” for extended periods may affect device reliability.

Recommended Operating Conditions

Symbol	Parameter	Min	Max	Unit
V _{IN}	Supply Voltage	2.7	5.5	V
T _A	Operating Ambient Temperature Range	-40	+85	°C

NOT RECOMMENDED FOR NEW DESIGN

Electrical Characteristics ($V_{IN} = 5.0V$, $C_{IN} = 2.2\mu F$, $C_{OUT} = 1.0\mu F$, Typical $T_A = +25^\circ C$, unless otherwise specified)

Symbol	Parameter	Conditions	Min	Typ	Max	Unit
V_{IN}	Supply Voltage	—	2.7	—	5.5	V
$R_{DS(ON)}$	Switch On Resistance	$V_{IN} = 5.0V$, $I_{OUT} = 2.0A$	—	85	110	m Ω
I_{LIMIT}	Current Limit	AP2822A/B(0.5A), $V_{OUT} = 4.0V$	0.7	1.0	1.4	A
		AP2822C/D(1.0A), $V_{OUT} = 4.0V$	1.1	1.5	2.1	
		AP2822E/F(1.5A), $V_{OUT} = 4.0V$	1.65	2.2	2.8	
		AP2822G/H(2.0A), $V_{OUT} = 4.0V$	2.2	2.7	3.2	
I_{SUPPLY}	Supply Current	$V_{IN} = 5.0V$, No Load	—	68	95	μA
I_{SHORT}	Fold-back Short Current	AP2822 A/B/C/D, $V_{OUT} = 0V$	—	0.7	—	A
		AP2822 E/F/G/H, $V_{OUT} = 0V$	—	1.1	—	
$I_{SHUTDOWN}$	Shutdown Supply Current	Chip Disable, Shutdown Mode	—	0.1	1.0	μA
V_{ENH}	Enable High Input Threshold	—	1.6	—	5.5	V
V_{ENL}	Enable Low Input Threshold	—	0	—	1.0	V
I_{EN}	Enable Pin Input Current	Force 0V to 5.0V at EN Pin	-1.0	—	1.0	μA
V_{UVLO}	Under Voltage Lockout Threshold Voltage	V_{IN} Increasing from 0V	2.2	2.5	3.0	V
V_{UVLOHY}	Under Voltage Hysteresis	—	—	0.2	—	V
$I_{REVERSE}$	Reverse Current	Chip Disable, $V_{OUT} > V_{IN}$	—	0.1	1.0	μA
$R_{DISCHARGE}$	Output Pull Low Resistance after Shutdown	With Auto-discharge	—	100	200	Ω
$I_{SHDN_LEAKAGE}$	Output Leakage Current after Shutdown	Without Auto-discharge	—	—	1.0	μA
t_{ON}	Output Turn-on Time	From Enable Active to 90% of Output	—	500	—	μs
t_{DFLG}	FLAG Pin Delay Time	From Over Current Fault Condition to Flag Active	5	10	15	ms
V_{FLG}	FLAG Pin Low Voltage	$I_{SINK} = 5.0mA$	—	35	70	mV
$I_{LEAKAGE}$	FLAG Pin Leakage Current	FLAG Disable, Force 5.0V	—	—	1.0	μA
T_{OTSD}	Thermal Shutdown Temperature	—	—	+150	—	$^\circ C$
T_{HYOTSD}	Thermal Shutdown Hysteresis	—	—	+30	—	
θ_{JC}	Thermal Resistance (Junction to Case)	—	—	93	—	$^\circ C/W$

Performance Characteristics

Supply Current vs. Ambient Temperature

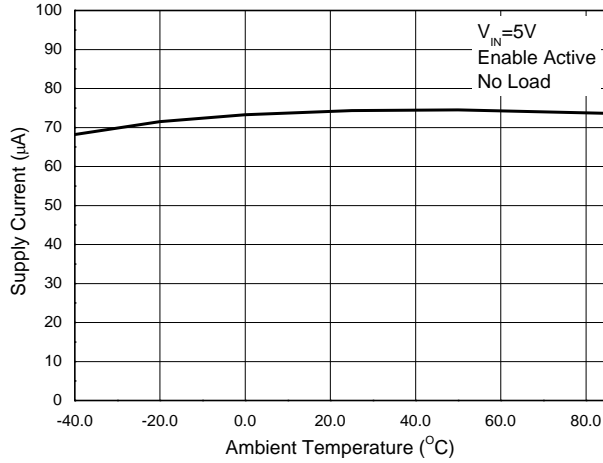

Supply Current vs. Supply Voltage

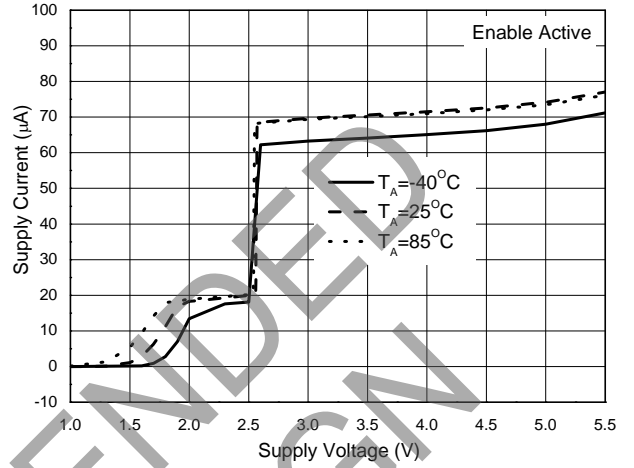

$R_{DS(ON)}$ vs. Ambient Temperature

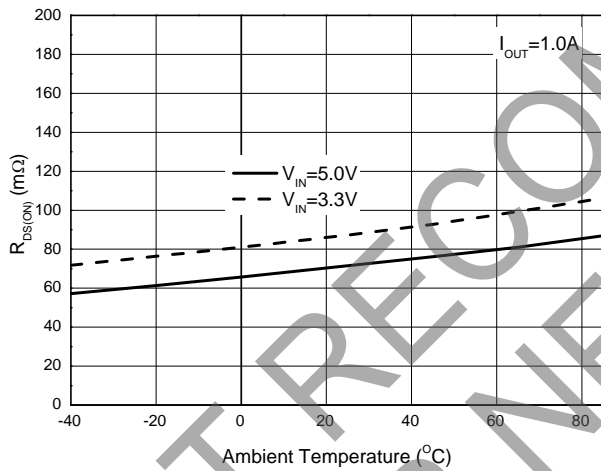

$R_{DS(ON)}$ vs. Supply Voltage

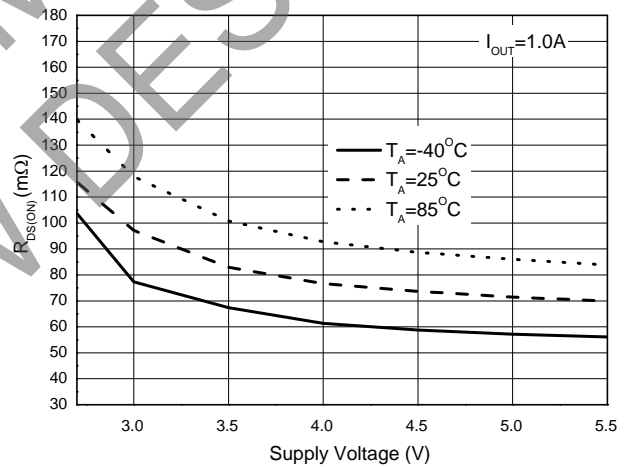

Current Limit vs. Supply Voltage

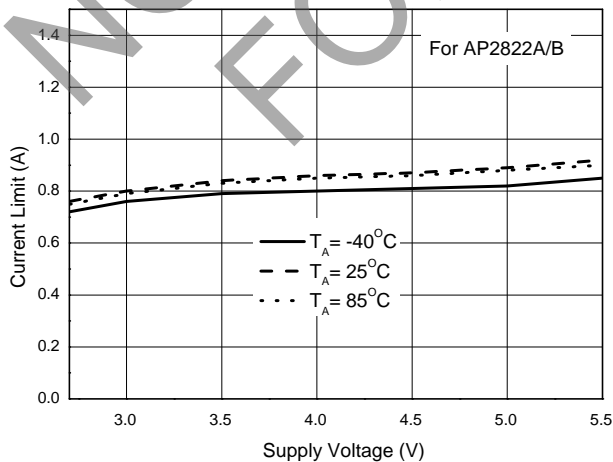

Current Limit vs. Ambient Temperature

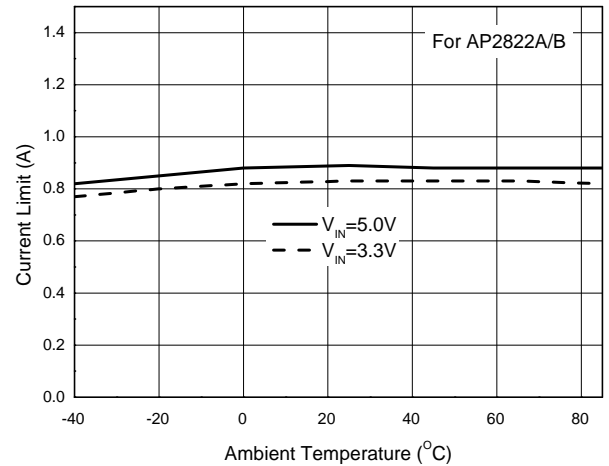

Performance Characteristics (Cont.)

Current Limit vs. Supply Voltage

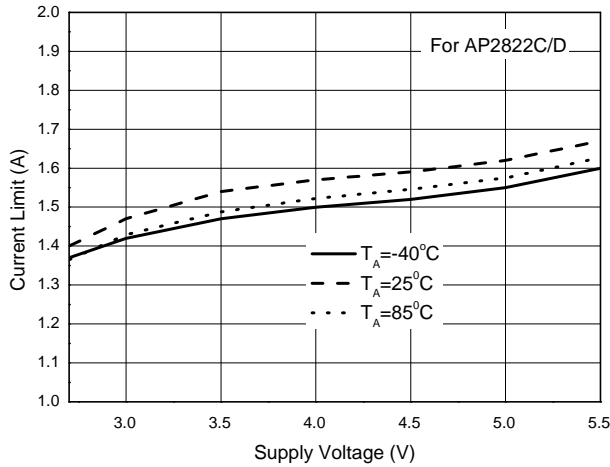

Current Limit vs. Ambient Temperature

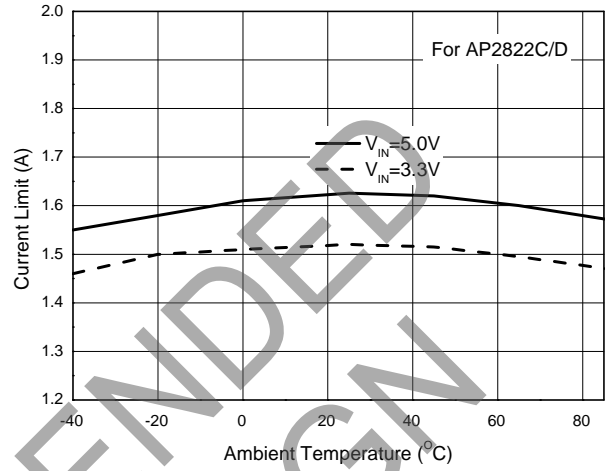

Current Limit vs. Supply Voltage

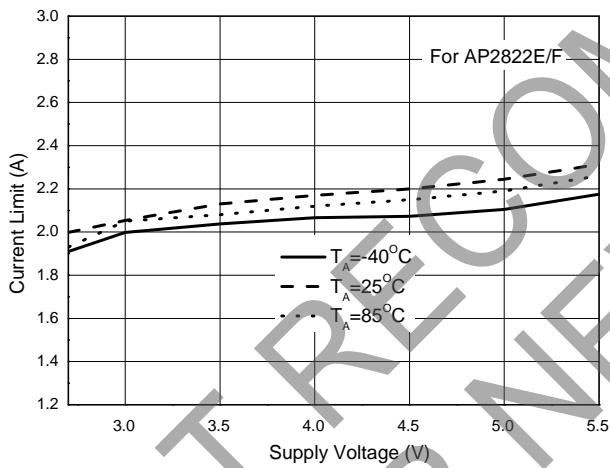

Current Limit vs. Ambient Temperature

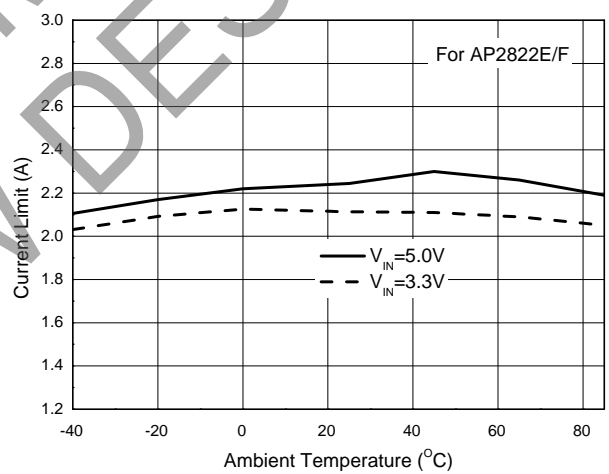

Current Limit vs. Supply Voltage

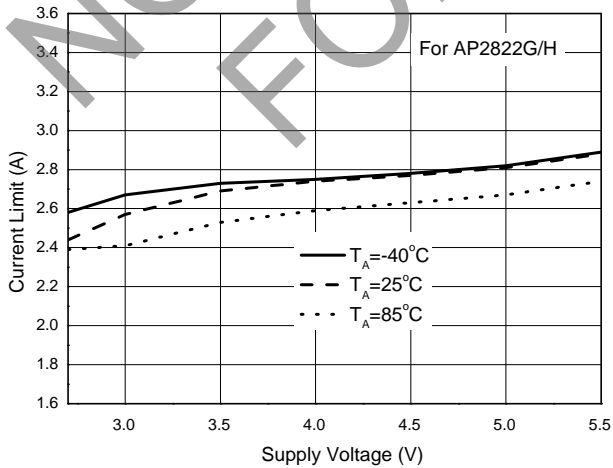

Current Limit vs. Ambient Temperature

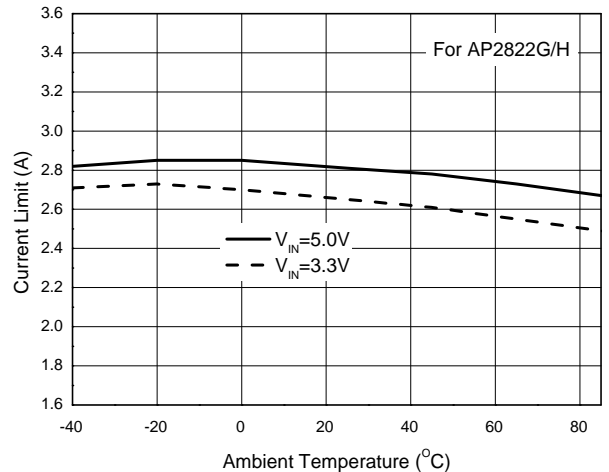

Performance Characteristics (Cont.)

UVLO Voltage vs. Ambient Temperature

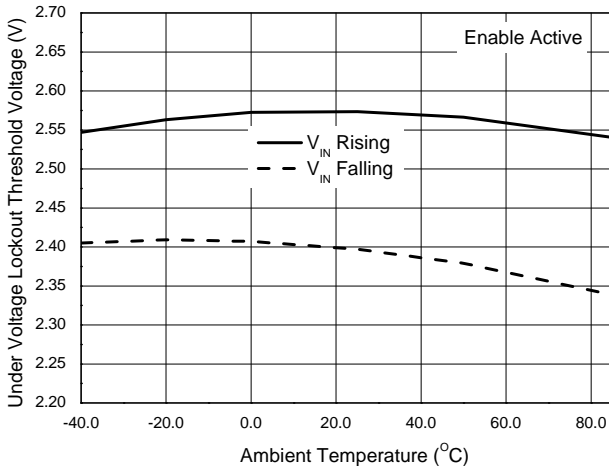

Flag Delay Time during Over Current vs. Ambient Temperature

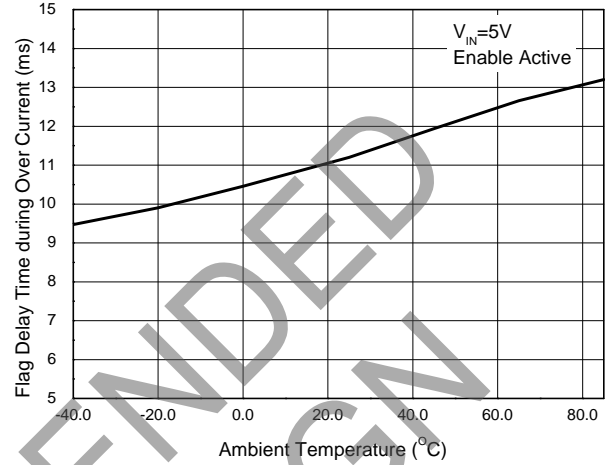

Flag Delay Time during Over Current vs. Supply Voltage

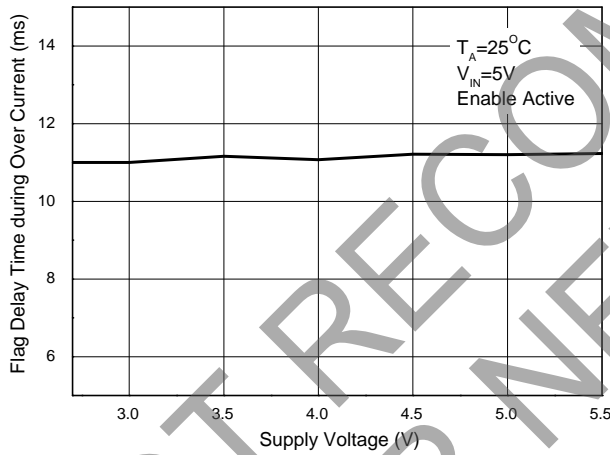

Output Short to GND Current vs. Supply Voltage

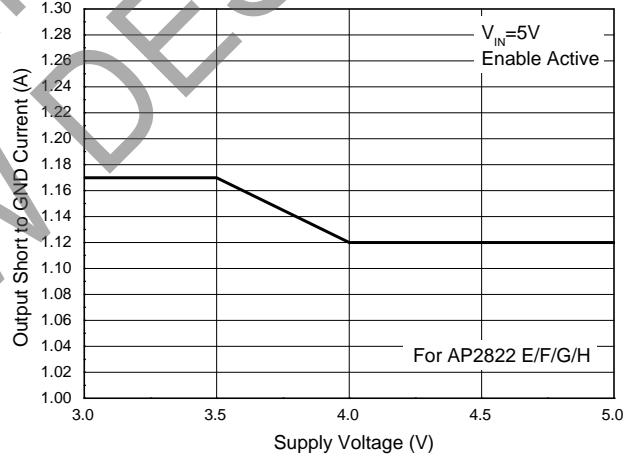

Output Short to GND Current vs. Ambient Temperature

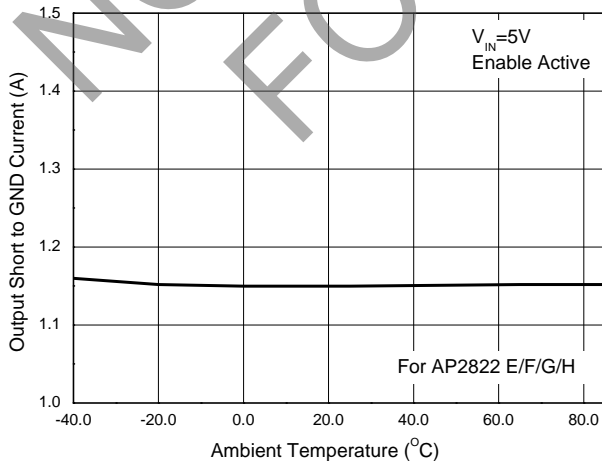

Enable Threshold Voltage vs. Ambient Temperature

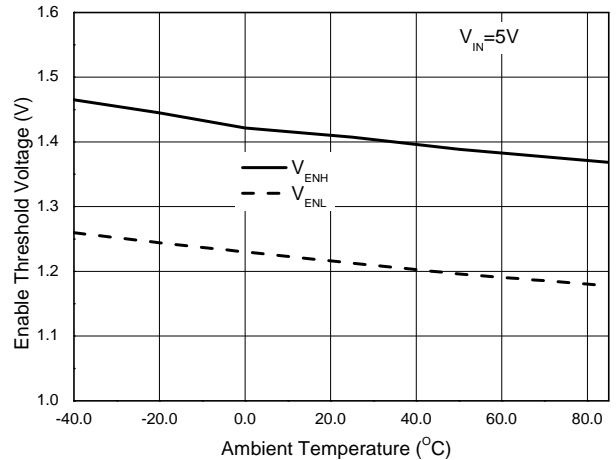

Performance Characteristics (Cont.)

Enable Threshold Voltage vs. Supply Voltage

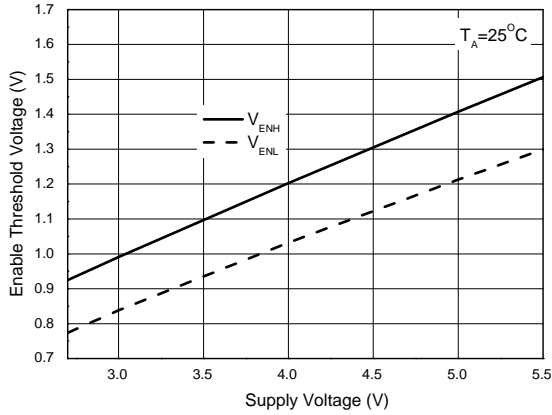

Output Turn On and Rise Time (C_{IN} = 1.0μF, C_{OUT} = 1.0μF, No Load)

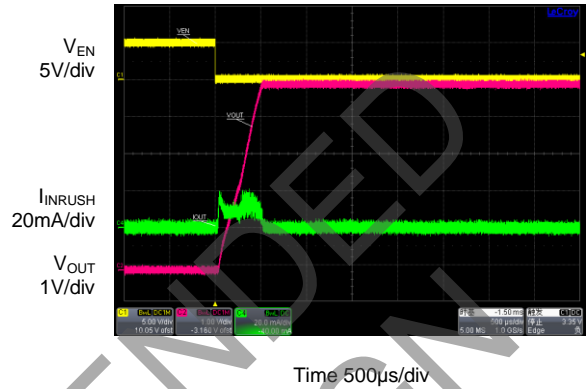

Output Turn On and Rise Time (C_{IN} = 1.0μF, C_{OUT} = 1.0μF, R_L = 3.3Ω)

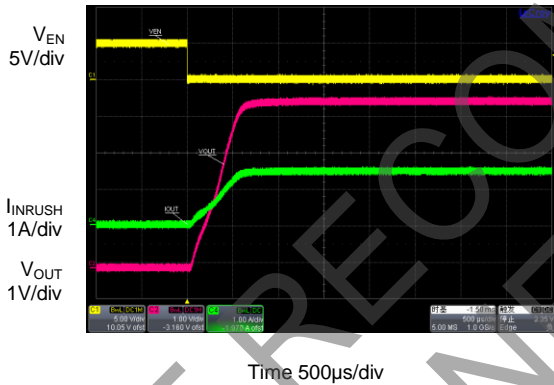

Output Turn On and Rise Time (C_{IN} = 1.0μF, C_{OUT} = 100μF, No Load)

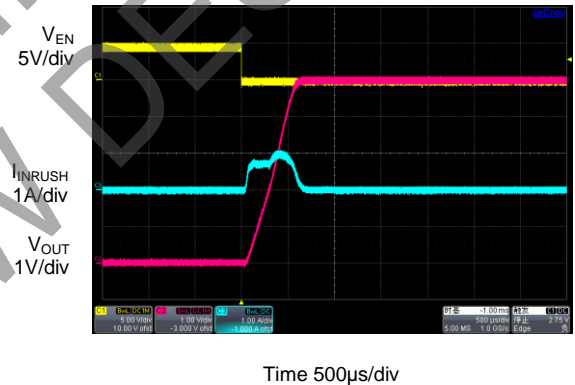

Output Turn Off and Fall Time (V_{IN} = 5V, C_{IN} = 1.0μF, No Load)

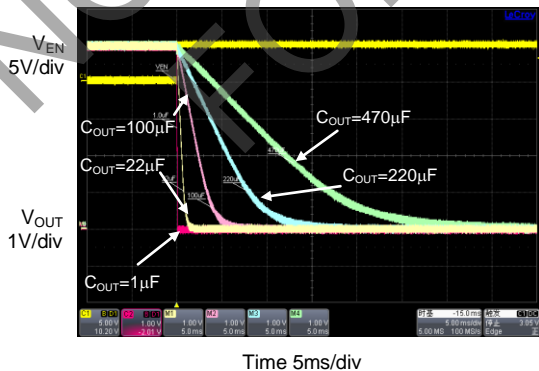

Output Turn Off and Fall Time (V_{IN} = 5V, C_{IN} = 1.0μF, C_{OUT} = 470μF, R_L = 3.3Ω)

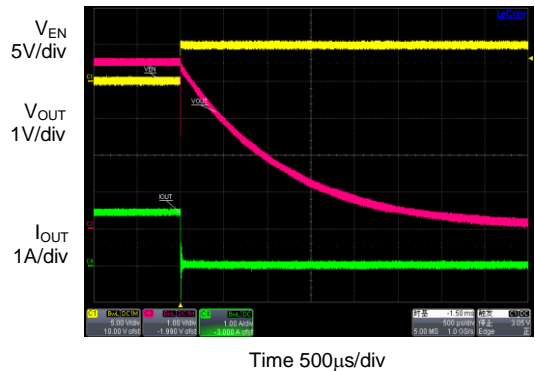

Performance Characteristics (Cont.)

Output Short to GND Current
($V_{IN} = 5V, C_{IN} = 1.0\mu F$)



Time 20ms/div

FLAG Response during Over Current

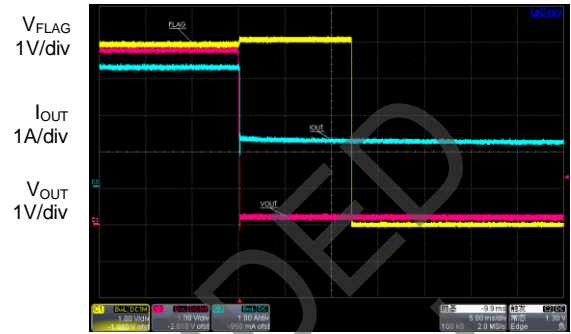

Time 5ms/div

FLAG Response during Over Temperature
($T_A = +125^{\circ}C$)

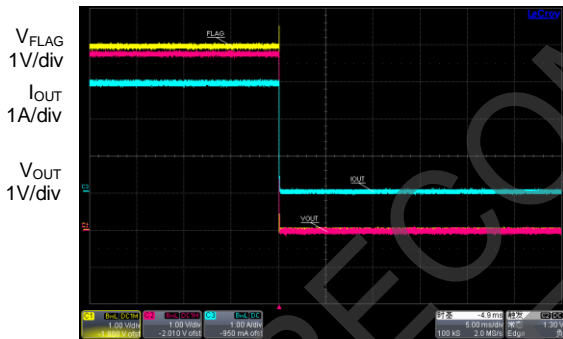

Time 5ms/div

NOT RECOMMENDED FOR NEW DESIGN

Ordering Information

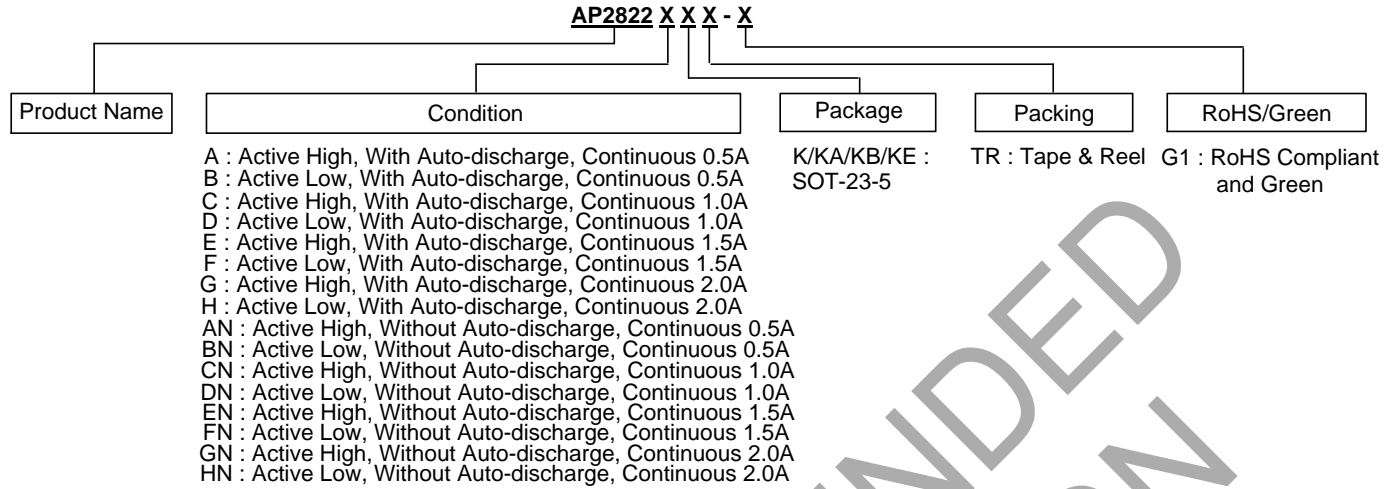

Package	Temperature Range	Condition	Part Number	Marking ID	Packing
SOT-23-5	-40 to +85°C	Active High, With Auto-discharge (Continuous 0.5A)	AP2822AKTR-G1	GCO	3000/Tape & Reel
		Active Low, With Auto-discharge (Continuous 0.5A)	AP2822BKTR-G1	GCR	3000/Tape & Reel
		Active High, With Auto-discharge (Continuous 1.0A)	AP2822CKTR-G1	GCS	3000/Tape & Reel
		Active Low, With Auto-discharge (Continuous 1.0A)	AP2822DKTR-G1	GCT	3000/Tape & Reel
		Active High, With Auto-discharge (Continuous 1.5A)	AP2822EKTR-G1	GCU	3000/Tape & Reel
		Active Low, With Auto-discharge (Continuous 1.5A)	AP2822FKTR-G1	GCV	3000/Tape & Reel
		Active High, With Auto-discharge (Continuous 2.0A)	AP2822GKTR-G1	GCW	3000/Tape & Reel
		Active Low, With Auto-discharge (Continuous 2.0A)	AP2822HKTR-G1	GCZ	3000/Tape & Reel
SOT-23-5	-40 to +85°C	Active High, Without Auto-discharge (Continuous 0.5A)	AP2822ANKTR-G1	GMQ	3000/Tape & Reel
		Active Low, Without Auto-discharge (Continuous 0.5A)	AP2822BNKTR-G1	GMR	3000/Tape & Reel
		Active High, Without Auto-discharge (Continuous 1.0A)	AP2822CNKTR-G1	GMS	3000/Tape & Reel
		Active Low, Without Auto-discharge (Continuous 1.0A)	AP2822DNKTR-G1	GMT	3000/Tape & Reel
		Active High, Without Auto-discharge (Continuous 1.5A)	AP2822ENKTR-G1	GMU	3000/Tape & Reel
		Active Low, Without Auto-discharge (Continuous 1.5A)	AP2822FNKTR-G1	GMV	3000/Tape & Reel
		Active High, Without Auto-discharge (Continuous 2.0A)	AP2822GNKTR-G1	GMW	3000/Tape & Reel
		Active Low, Without Auto-discharge (Continuous 2.0A)	AP2822HNKTR-G1	GMZ	3000/Tape & Reel

Ordering Information (Cont.)

Package	Temperature Range	Condition	Part Number	Marking ID	Packing
SOT-23-5	-40 to +85°C	Active High, With Auto-discharge (Continuous 0.5A)	AP2822AKATR-G1	GDQ	3000/Tape & Reel
		Active Low, With Auto-discharge (Continuous 0.5A)	AP2822BKATR-G1	GDR	3000/Tape & Reel
		Active High, With Auto-discharge (Continuous 1.0A)	AP2822CKATR-G1	GDS	3000/Tape & Reel
		Active Low, With Auto-discharge (Continuous 1.0A)	AP2822DKATR-G1	GDT	3000/Tape & Reel
		Active High, With Auto-discharge (Continuous 1.5A)	AP2822EKATR-G1	GDU	3000/Tape & Reel
		Active Low, With Auto-discharge (Continuous 1.5A)	AP2822FKATR-G1	GDV	3000/Tape & Reel
		Active High, With Auto-discharge (Continuous 2.0A)	AP2822GKATR-G1	GDW	3000/Tape & Reel
		Active Low, With Auto-discharge (Continuous 2.0A)	AP2822HKATR-G1	GDZ	3000/Tape & Reel
SOT-23-5	-40 to +85°C	Active High, Without Auto-discharge (Continuous 0.5A)	AP2822ANKATR-G1	G5Q	3000/Tape & Reel
		Active Low, Without Auto-discharge (Continuous 0.5A)	AP2822BNKATR-G1	G5R	3000/Tape & Reel
		Active High, Without Auto-discharge (Continuous 1.0A)	AP2822CNKATR-G1	G5S	3000/Tape & Reel
		Active Low, Without Auto-discharge (Continuous 1.0A)	AP2822DNKATR-G1	G5T	3000/Tape & Reel
		Active High, Without Auto-discharge (Continuous 1.5A)	AP2822ENKATR-G1	G5U	3000/Tape & Reel
		Active Low, Without Auto-discharge (Continuous 1.5A)	AP2822FNKATR-G1	G5V	3000/Tape & Reel
		Active High, Without Auto-discharge (Continuous 2.0A)	AP2822GNKATR-G1	G5W	3000/Tape & Reel
		Active Low, Without Auto-discharge (Continuous 2.0A)	AP2822HNKATR-G1	G5Z	3000/Tape & Reel
SOT-23-5	-40 to +85°C	Active High, With Auto-discharge (Continuous 0.5A)	AP2822AKBTR-G1	GLA	3000/Tape & Reel
		Active Low, With Auto-discharge (Continuous 0.5A)	AP2822BKBTR-G1	GLB	3000/Tape & Reel
		Active High, With Auto-discharge (Continuous 1.0A)	AP2822CKBTR-G1	GLC	3000/Tape & Reel
		Active Low, With Auto-discharge (Continuous 1.0A)	AP2822DKBTR-G1	GLD	3000/Tape & Reel
		Active High, With Auto-discharge (Continuous 1.5A)	AP2822EKBTR-G1	GLE	3000/Tape & Reel
		Active Low, With Auto-discharge (Continuous 1.5A)	AP2822FKBTR-G1	GLF	3000/Tape & Reel
		Active High, With Auto-discharge (Continuous 2.0A)	AP2822GKBTR-G1	GLG	3000/Tape & Reel
		Active Low, With Auto-discharge (Continuous 2.0A)	AP2822HKBTR-G1	GLH	3000/Tape & Reel

Ordering Information (Cont.)

Package	Temperature Range	Condition	Part Number	Marking ID	Packing
SOT-23-5	-40 to +85°C	Active High, Without Auto-discharge (Continuous 0.5A)	AP2822ANKBTR-G1	GMA	3000/Tape & Reel
		Active Low, Without Auto-discharge (Continuous 0.5A)	AP2822BNKBTR-G1	GMB	3000/Tape & Reel
		Active High, Without Auto-discharge (Continuous 1.0A)	AP2822CNKBTR-G1	GMC	3000/Tape & Reel
		Active Low, Without Auto-discharge (Continuous 1.0A)	AP2822DNKBTR-G1	GMD	3000/Tape & Reel
		Active High, Without Auto-discharge (Continuous 1.5A)	AP2822ENKBTR-G1	GME	3000/Tape & Reel
		Active Low, Without Auto-discharge (Continuous 1.5A)	AP2822FNKBTR-G1	GMF	3000/Tape & Reel
		Active High, Without Auto-discharge (Continuous 2.0A)	AP2822GNKBTR-G1	GMG	3000/Tape & Reel
		Active Low, Without Auto-discharge (Continuous 2.0A)	AP2822HNKBTR-G1	GMH	3000/Tape & Reel
SOT-23-5	-40 to +85°C	Active High, With Auto-discharge (Continuous 0.5A)	AP2822AKETR-G1	GLI	3000/Tape & Reel
		Active Low, With Auto-discharge (Continuous 0.5A)	AP2822BKETR-G1	GLJ	3000/Tape & Reel
		Active High, With Auto-discharge (Continuous 1.0A)	AP2822CKETR-G1	GLK	3000/Tape & Reel
		Active Low, With Auto-discharge (Continuous 1.0A)	AP2822DKETR-G1	GLL	3000/Tape & Reel
		Active High, With Auto-discharge (Continuous 1.5A)	AP2822EKETR-G1	GLM	3000/Tape & Reel
		Active Low, With Auto-discharge (Continuous 1.5A)	AP2822FKETR-G1	GLN	3000/Tape & Reel
		Active High, With Auto-discharge (Continuous 2.0A)	AP2822GKETR-G1	GLO	3000/Tape & Reel
		Active Low, With Auto-discharge (Continuous 2.0A)	AP2822HKETR-G1	GLP	3000/Tape & Reel
SOT-23-5	-40 to +85°C	Active High, Without Auto-discharge (Continuous 0.5A)	AP2822ANKETR-G1	GMI	3000/Tape & Reel
		Active Low, Without Auto-discharge (Continuous 0.5A)	AP2822BNKETR-G1	GMJ	3000/Tape & Reel
		Active High, Without Auto-discharge (Continuous 1.0A)	AP2822CNKETR-G1	GMK	3000/Tape & Reel
		Active Low, Without Auto-discharge (Continuous 1.0A)	AP2822DNKETR-G1	GML	3000/Tape & Reel
		Active High, Without Auto-discharge (Continuous 1.5A)	AP2822ENKETR-G1	GMM	3000/Tape & Reel
		Active Low, Without Auto-discharge (Continuous 1.5A)	AP2822FNKETR-G1	GMN	3000/Tape & Reel
		Active High, Without Auto-discharge (Continuous 2.0A)	AP2822GNKETR-G1	GMO	3000/Tape & Reel
		Active Low, Without Auto-discharge (Continuous 2.0A)	AP2822HNKETR-G1	GMP	3000/Tape & Reel

Marking Information

(1) SOT-23-5

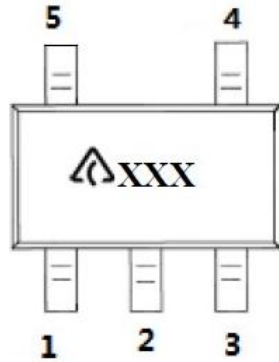

: Logo
XXX: Marking ID (See Ordering Information)

Package Outline Dimensions (All dimensions in mm(inch).)

(1) Package Type: SOT-23-5

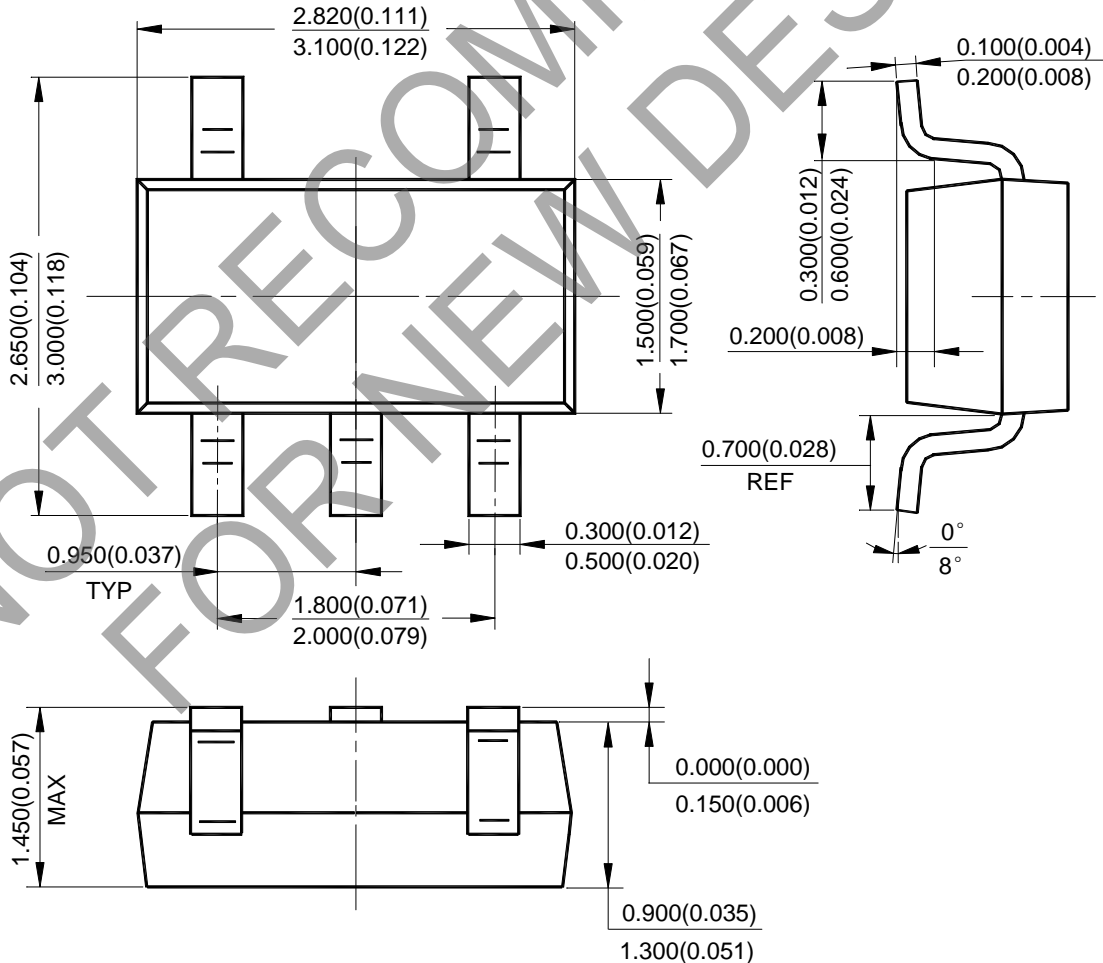

Suggested Pad Layout

(1) Package Type: SOT-23-5

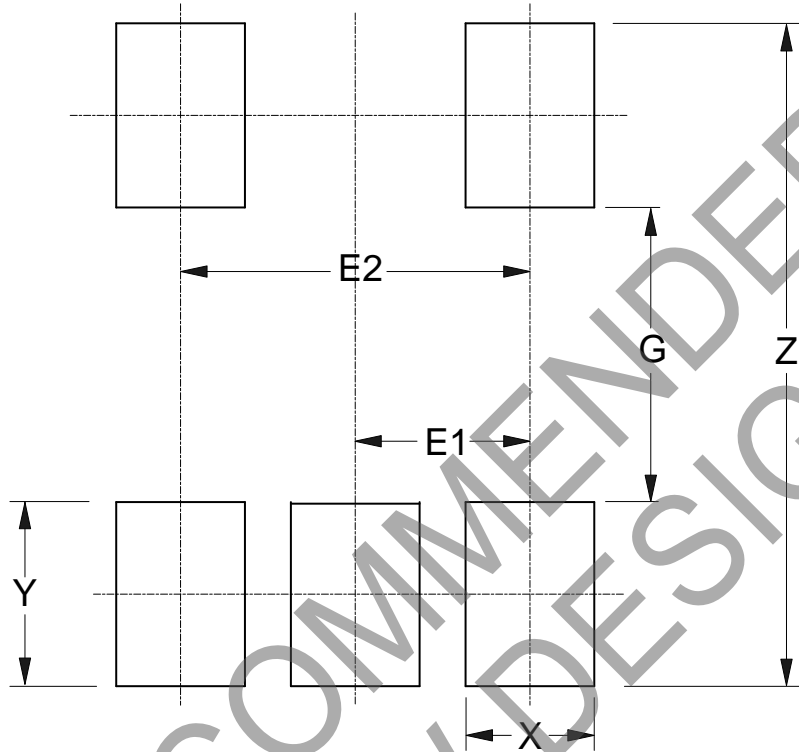

Dimensions	Z (mm)/(inch)	G (mm)/(inch)	X (mm)/(inch)	Y (mm)/(inch)	E1 (mm)/(inch)	E2 (mm)/(inch)
Value	3.600/0.142	1.600/0.063	0.700/0.028	1.000/0.039	0.950/0.037	1.900/0.075

NOT RECOMMENDED FOR NEW DESIGN

IMPORTANT NOTICE

DIODES INCORPORATED MAKES NO WARRANTY OF ANY KIND, EXPRESS OR IMPLIED, WITH REGARDS TO THIS DOCUMENT, INCLUDING, BUT NOT LIMITED TO, THE IMPLIED WARRANTIES OF MERCHANTABILITY AND FITNESS FOR A PARTICULAR PURPOSE (AND THEIR EQUIVALENTS UNDER THE LAWS OF ANY JURISDICTION).

Diodes Incorporated and its subsidiaries reserve the right to make modifications, enhancements, improvements, corrections or other changes without further notice to this document and any product described herein. Diodes Incorporated does not assume any liability arising out of the application or use of this document or any product described herein; neither does Diodes Incorporated convey any license under its patent or trademark rights, nor the rights of others. Any Customer or user of this document or products described herein in such applications shall assume all risks of such use and will agree to hold Diodes Incorporated and all the companies whose products are represented on Diodes Incorporated website, harmless against all damages.

Diodes Incorporated does not warrant or accept any liability whatsoever in respect of any products purchased through unauthorized sales channel. Should Customers purchase or use Diodes Incorporated products for any unintended or unauthorized application, Customers shall indemnify and hold Diodes Incorporated and its representatives harmless against all claims, damages, expenses, and attorney fees arising out of, directly or indirectly, any claim of personal injury or death associated with such unintended or unauthorized application.

Products described herein may be covered by one or more United States, international or foreign patents pending. Product names and markings noted herein may also be covered by one or more United States, international or foreign trademarks.

This document is written in English but may be translated into multiple languages for reference. Only the English version of this document is the final and determinative format released by Diodes Incorporated.

LIFE SUPPORT

Diodes Incorporated products are specifically not authorized for use as critical components in life support devices or systems without the express written approval of the Chief Executive Officer of Diodes Incorporated. As used herein:

- A. Life support devices or systems are devices or systems which:
 - 1. are intended to implant into the body, or
 - 2. support or sustain life and whose failure to perform when properly used in accordance with instructions for use provided in the labeling can be reasonably expected to result in significant injury to the user.
- B. A critical component is any component in a life support device or system whose failure to perform can be reasonably expected to cause the failure of the life support device or to affect its safety or effectiveness.

Customers represent that they have all necessary expertise in the safety and regulatory ramifications of their life support devices or systems, and acknowledge and agree that they are solely responsible for all legal, regulatory and safety-related requirements concerning their products and any use of Diodes Incorporated products in such safety-critical, life support devices or systems, notwithstanding any devices- or systems-related information or support that may be provided by Diodes Incorporated. Further, Customers must fully indemnify Diodes Incorporated and its representatives against any damages arising out of the use of Diodes Incorporated products in such safety-critical, life support devices or systems.

Copyright © 2018, Diodes Incorporated

www.diodes.com

Looking for pricing, stock, or lifecycle information?

Click below to explore more details on WIN SOURCE:

 [View AP2822CKATR-G1 on WIN SOURCE](#)

 [Diodes Incorporated Information](#)

Optimize Your Supply Chain with WIN SOURCE Solutions

-  Global Sourcing Solution
-  Obsolete Management
-  Cost Control Management
-  Shortage Management
-  Alternative Solution
-  Excess Inventory Management