



**THE DATASHEET OF  
AOK60B65M3**



### General Description

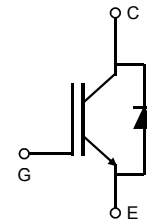
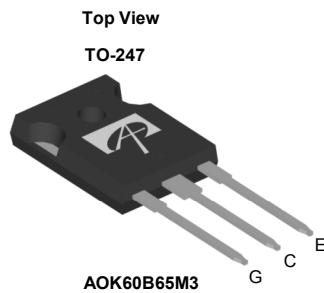
- Latest Alpha IGBT (α IGBT) technology
- 650V breakdown voltage
- Very fast and soft recovery freewheeling diode
- High efficient turn-on di/dt controllability
- Low VCE(SAT) enables high efficiencies
- Low turn-off switching loss and softness
- Very good EMI behavior
- High short-circuit ruggedness

### Applications

- Motor Drives
- Welding Machines
- UPS and Solar Inverters
- Other hard switching applications

### Product Summary

$V_{CE}$	650V
$I_C$ ( $T_C=100^\circ\text{C}$ )	60A
$V_{CE(sat)}$ ( $T_J=25^\circ\text{C}$ )	1.94V



Orderable Part Number	Package Type	Form	Minimum Order Quantity
AOK60B65M3	TO247	Tube	240
<b>Absolute Maximum Ratings <math>T_A=25^\circ\text{C}</math> unless otherwise noted</b>			
Parameter	Symbol	AOK60B65M3	Units
Collector-Emitter Voltage	$V_{CE}$	650	V
Gate-Emitter Voltage	$V_{GE}$	$\pm 30$	V
Continuous Collector Current	$I_C$	$T_C=25^\circ\text{C}$	120
		$T_C=100^\circ\text{C}$	60
Pulsed Collector Current, Limited by $T_{Jmax}$	$I_{CM}$	180	A
Turn off SOA, $V_{CE} \leq 650\text{V}$ , Limited by $T_{Jmax}$	$I_{LM}$	180	A
Continuous Diode Forward Current	$I_F$	$T_C=25^\circ\text{C}$	60
		$T_C=100^\circ\text{C}$	30
Diode Pulsed Current, Limited by $T_{Jmax}$	$I_{FM}$	180	A
Short circuit withstanding time $t_1$ $V_{GE} = 15\text{V}$ , $V_{CC} \leq 400\text{V}$ , $T_J \leq 175^\circ\text{C}$	$t_{SC}$	5	$\mu\text{s}$
Power Dissipation	$P_D$	$T_C=25^\circ\text{C}$	500
		$T_C=100^\circ\text{C}$	250
Junction and Storage Temperature Range	$T_J, T_{STG}$	-55 to 175	$^\circ\text{C}$
Maximum lead temperature for soldering purpose, 1/8" from case for 5 seconds	$T_L$	300	$^\circ\text{C}$
<b>Thermal Characteristics</b>			
Parameter	Symbol	AOK60B65M3	Units
Maximum Junction-to-Ambient	$R_{\theta JA}$	40	$^\circ\text{C/W}$
Maximum IGBT Junction-to-Case	$R_{\theta JC}$	0.3	$^\circ\text{C/W}$
Maximum Diode Junction-to-Case	$R_{\theta JC}$	1	$^\circ\text{C/W}$

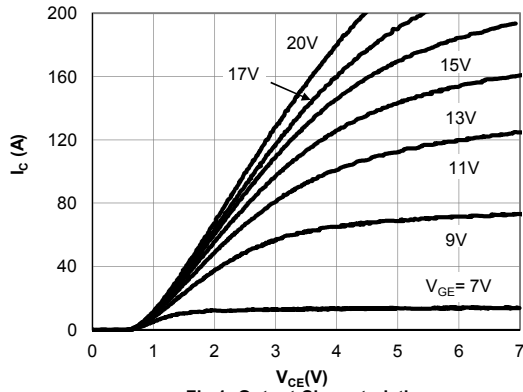
1) Allowed number of short circuits: <1000; time between short circuits: >1s.

**Electrical Characteristics (T<sub>J</sub>=25°C unless otherwise noted)**

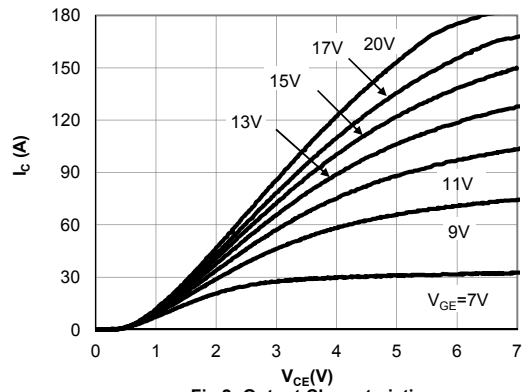
Symbol	Parameter	Conditions	Min	Typ	Max	Units	
<b>STATIC PARAMETERS</b>							
$BV_{CES}$	Collector-Emitter Breakdown Voltage	$I_C=1mA, V_{GE}=0V, T_J=25^\circ C$	650	-	-	V	
$V_{CE(sat)}$	Collector-Emitter Saturation Voltage	$V_{GE}=15V, I_C=60A$	$T_J=25^\circ C$	-	1.94	2.45	V
			$T_J=125^\circ C$	-	2.35	-	
			$T_J=175^\circ C$	-	2.6	-	
$V_F$	Diode Forward Voltage	$V_{GE}=0V, I_C=60A$	$T_J=25^\circ C$	-	1.91	2.4	V
			$T_J=125^\circ C$	-	2.15	-	
			$T_J=175^\circ C$	-	2.1	-	
$V_{GE(th)}$	Gate-Emitter Threshold Voltage	$V_{CE}=5V, I_C=1mA$	-	4.8	-	V	
$I_{CES}$	Zero Gate Voltage Collector Current	$V_{CE}=650V, V_{GE}=0V$	$T_J=25^\circ C$	-	-	10	μA
			$T_J=125^\circ C$	-	-	1000	
			$T_J=175^\circ C$	-	-	15000	
$I_{GES}$	Gate-Emitter leakage current	$V_{CE}=0V, V_{GE}=\pm 30V$	-	-	±100	nA	
$g_{FS}$	Forward Transconductance	$V_{CE}=20V, I_C=60A$	-	35	-	S	
<b>DYNAMIC PARAMETERS</b>							
$C_{ies}$	Input Capacitance	$V_{GE}=0V, V_{CC}=25V, f=1MHz$	-	2800	-	pF	
$C_{oes}$	Output Capacitance		-	330	-	pF	
$C_{res}$	Reverse Transfer Capacitance		-	118	-	pF	
$Q_g$	Total Gate Charge	$V_{GE}=15V, V_{CC}=520V, I_C=60A$	-	106	-	nC	
$Q_{ge}$	Gate to Emitter Charge		-	35	-	nC	
$Q_{gc}$	Gate to Collector Charge		-	41	-	nC	
$I_{C(SC)}$	Short circuit collector current	$V_{GE}=15V, V_{CC}=400V,$ $t_{sc} \leq 5\mu s, T_J \leq 175^\circ C$	-	222	-	A	
$R_g$	Gate resistance	$V_{GE}=0V, V_{CC}=0V, f=1MHz$	-	14	-	Ω	
<b>SWITCHING PARAMETERS, (Load Inductive, T<sub>J</sub>=25°C)</b>							
$t_{D(on)}$	Turn-On Delay Time	$T_J=25^\circ C$ $V_{GE}=15V, V_{CC}=400V, I_C=60A,$ $R_G=5\Omega$	-	44	-	ns	
$t_r$	Turn-On Rise Time		-	84	-	ns	
$t_{D(off)}$	Turn-Off Delay Time		-	166	-	ns	
$t_f$	Turn-Off Fall Time		-	75	-	ns	
$E_{on}$	Turn-On Energy		-	2.6	-	mJ	
$E_{off}$	Turn-Off Energy		-	1.3	-	mJ	
$E_{total}$	Total Switching Energy		-	3.9	-	mJ	
$t_{rr}$	Diode Reverse Recovery Time		$T_J=25^\circ C$	-	346	-	ns
$Q_{rr}$	Diode Reverse Recovery Charge		$I_F=60A, di/dt=200A/\mu s, V_{CC}=400V$	-	1.3	-	μC
$I_{rm}$	Diode Peak Reverse Recovery Current			-	7.5	-	A
<b>SWITCHING PARAMETERS, (Load Inductive, T<sub>J</sub>=175°C)</b>							
$t_{D(on)}$	Turn-On Delay Time	$T_J=175^\circ C$ $V_{GE}=15V, V_{CC}=400V, I_C=60A,$ $R_G=5\Omega$	-	42	-	ns	
$t_r$	Turn-On Rise Time		-	83	-	ns	
$t_{D(off)}$	Turn-Off Delay Time		-	208	-	ns	
$t_f$	Turn-Off Fall Time		-	77	-	ns	
$E_{on}$	Turn-On Energy		-	2.9	-	mJ	
$E_{off}$	Turn-Off Energy		-	1.9	-	mJ	
$E_{total}$	Total Switching Energy		-	4.8	-	mJ	
$t_{rr}$	Diode Reverse Recovery Time		$T_J=175^\circ C$	-	557	-	ns
$Q_{rr}$	Diode Reverse Recovery Charge		$I_F=60A, di/dt=200A/\mu s, V_{CC}=400V$	-	3.1	-	μC
$I_{rm}$	Diode Peak Reverse Recovery Current			-	11	-	A

THIS PRODUCT HAS BEEN DESIGNED AND QUALIFIED FOR THE CONSUMER MARKET. APPLICATIONS OR USES AS CRITICAL COMPONENTS IN LIFE SUPPORT DEVICES OR SYSTEMS ARE NOT AUTHORIZED. AOS DOES NOT ASSUME ANY LIABILITY ARISING OUT OF SUCH APPLICATIONS OR USES OF ITS PRODUCTS. AOS RESERVES THE RIGHT TO IMPROVE PRODUCT DESIGN, FUNCTIONS AND RELIABILITY WITHOUT NOTICE.

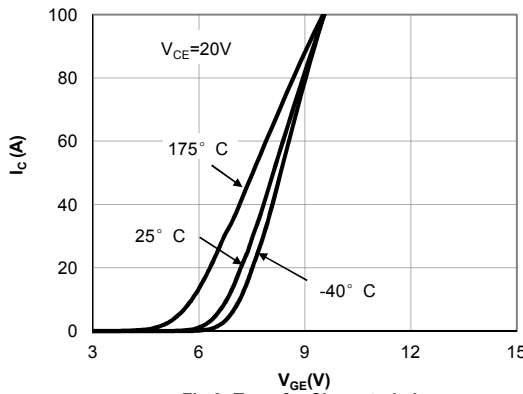
**TYPICAL ELECTRICAL AND THERMAL CHARACTERISTICS**



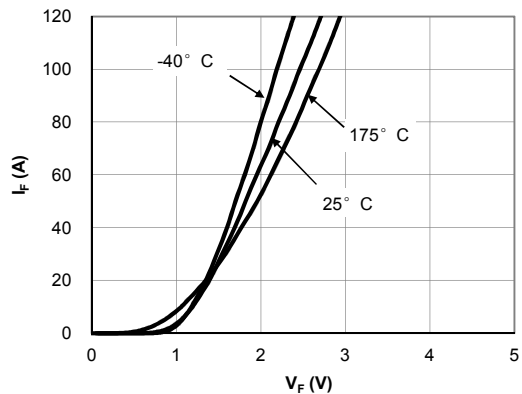
**Fig 1: Output Characteristic**  
( $T_j=25^\circ\text{C}$ )



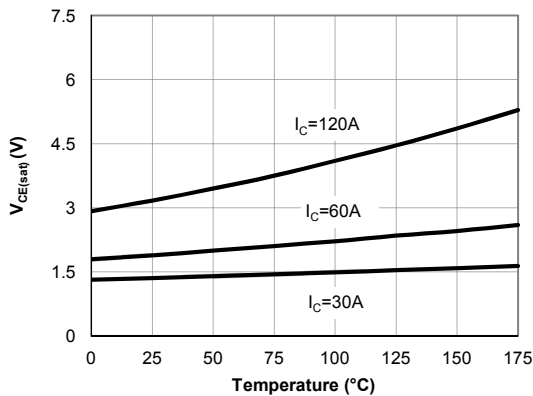
**Fig 2: Output Characteristic**  
( $T_j=175^\circ\text{C}$ )



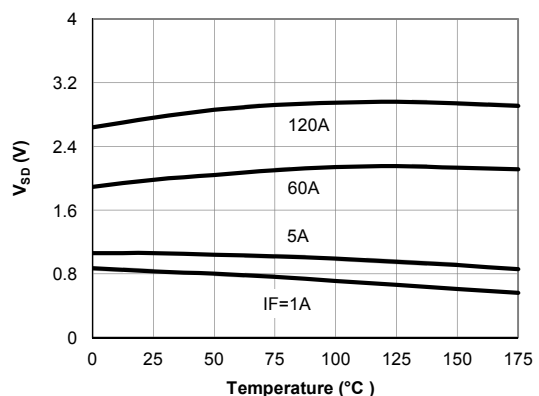
**Fig 3: Transfer Characteristic**



**Fig 4: Diode Characteristic**

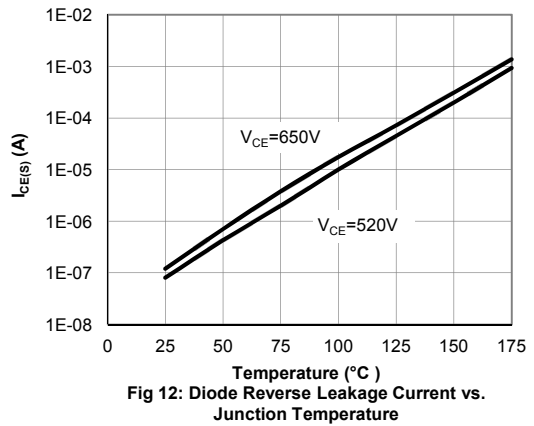
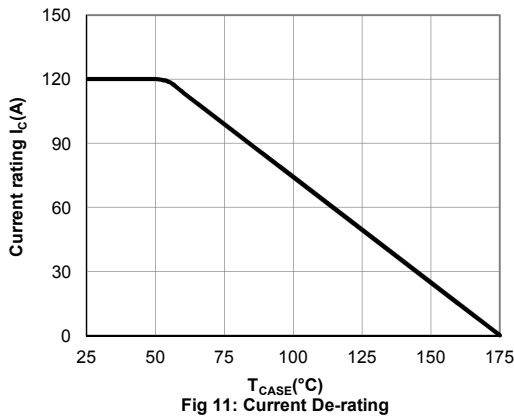
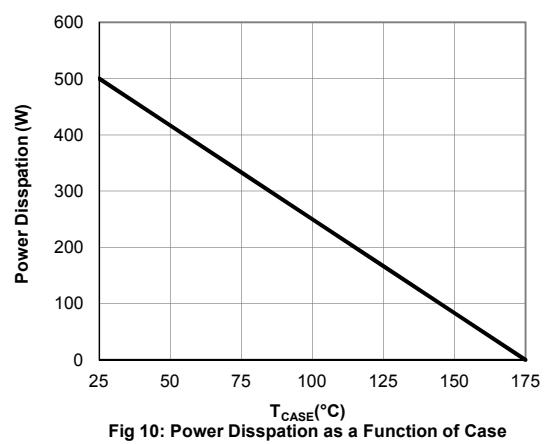
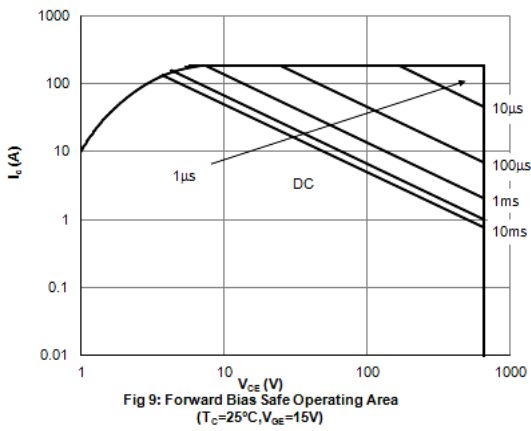
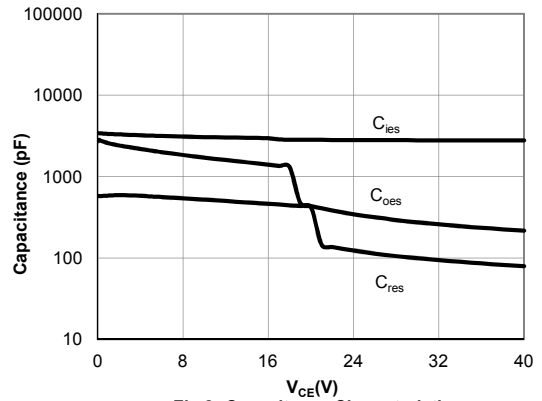
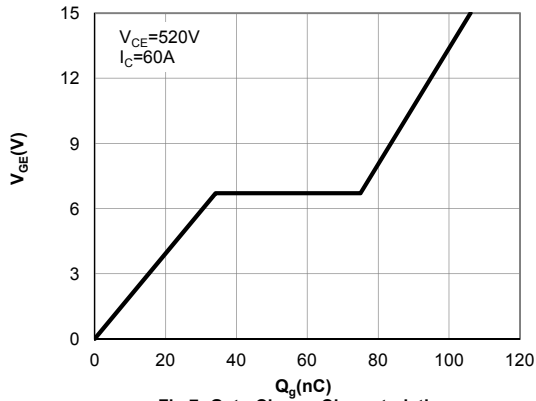


**Fig 5: Collector-Emitter Saturation Voltage vs. Junction Temperature**

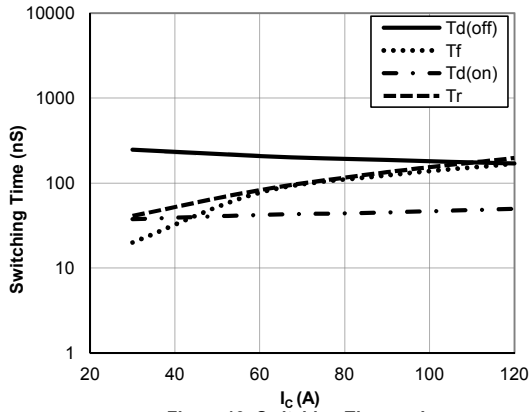


**Fig 6: Diode Forward voltage vs. Junction Temperature**

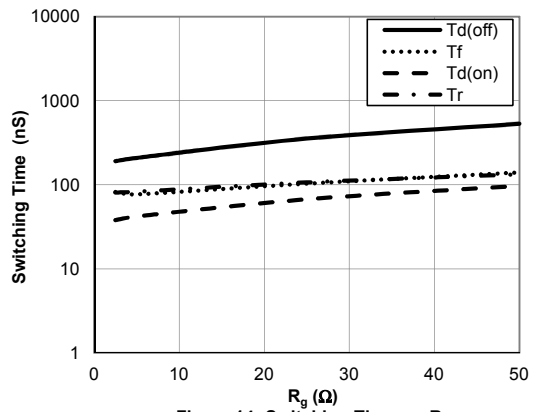
**TYPICAL ELECTRICAL AND THERMAL CHARACTERISTICS**



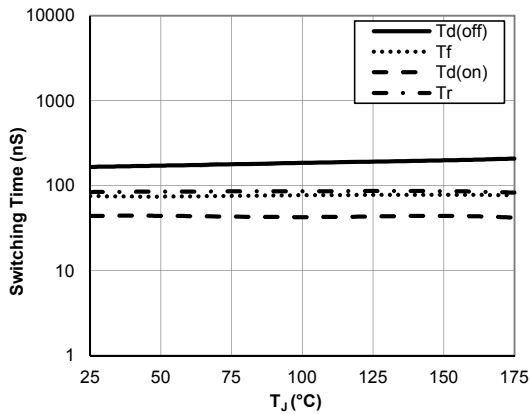
**TYPICAL ELECTRICAL AND THERMAL CHARACTERISTICS**



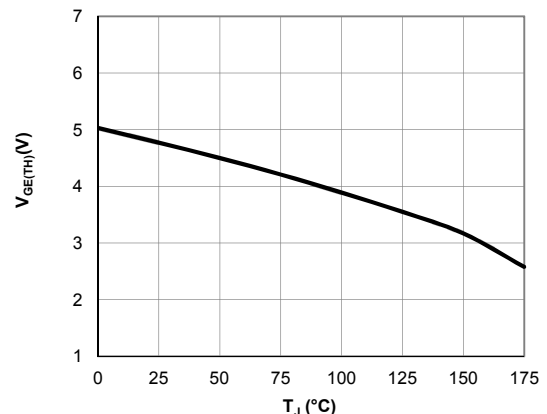
**Figure 13: Switching Time vs.  $I_C$**   
( $T_J=175^\circ\text{C}, V_{GE}=15\text{V}, V_{CE}=400\text{V}, R_g=5\Omega$ )



**Figure 14: Switching Time vs.  $R_g$**   
( $T_J=175^\circ\text{C}, V_{GE}=15\text{V}, V_{CE}=400\text{V}, I_C=60\text{A}$ )

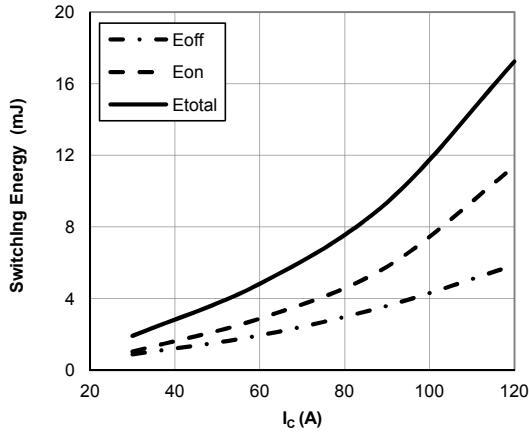


**Figure 15: Switching Time vs.  $T_J$**   
( $V_{GE}=15\text{V}, V_{CE}=400\text{V}, I_C=60\text{A}, R_g=5\Omega$ )

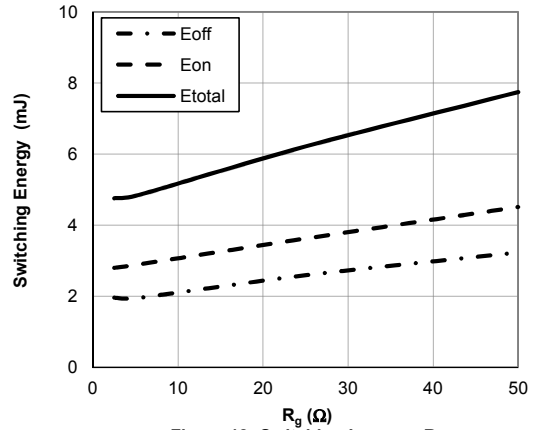


**Figure 16:  $V_{GE(TH)}$  vs.  $T_J$**

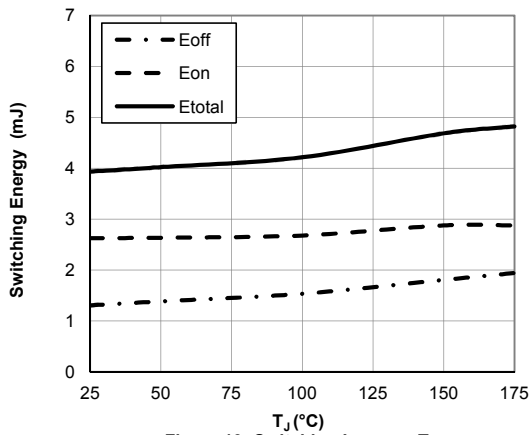
**TYPICAL ELECTRICAL AND THERMAL CHARACTERISTICS**



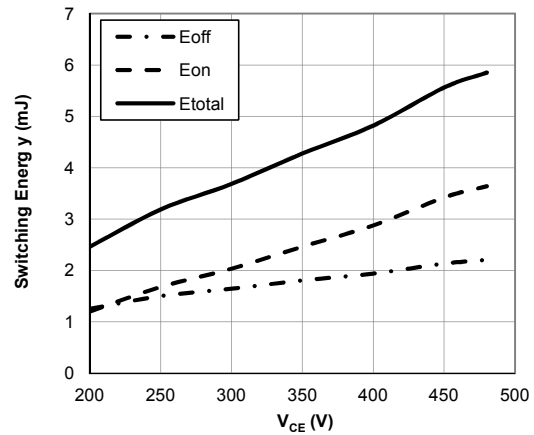
**Figure 17: Switching Loss vs.  $I_C$**   
( $T_J=175^\circ\text{C}, V_{GE}=15\text{V}, V_{CE}=400\text{V}, R_g=5\Omega$ )



**Figure 18: Switching Loss vs.  $R_g$**   
( $T_J=175^\circ\text{C}, V_{GE}=15\text{V}, V_{CE}=400\text{V}, I_C=60\text{A}$ )

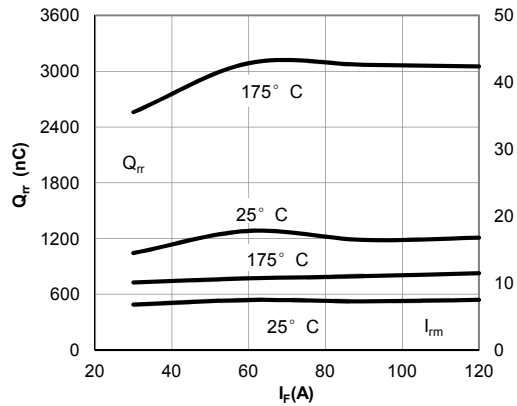


**Figure 19: Switching Loss vs.  $T_J$**   
( $V_{GE}=15\text{V}, V_{CE}=400\text{V}, I_C=60\text{A}, R_g=5\Omega$ )

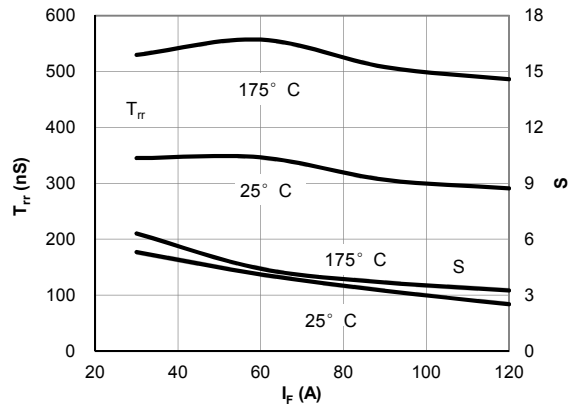


**Figure 20: Switching Loss vs.  $V_{CE}$**   
( $T_J=175^\circ\text{C}, V_{GE}=15\text{V}, I_C=60\text{A}, R_g=5\Omega$ )

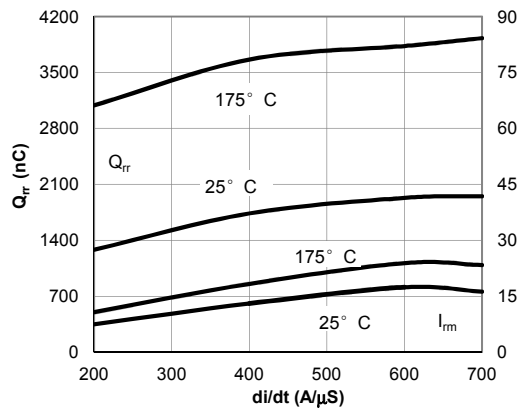
**TYPICAL ELECTRICAL AND THERMAL CHARACTERISTICS**



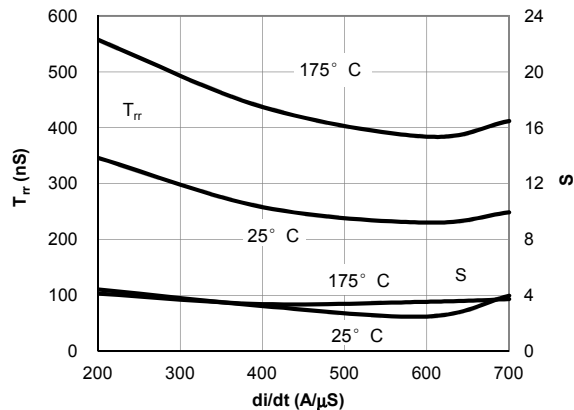
**Fig 21: Diode Reverse Recovery Charge and Peak Current vs. Conduction Current**  
( $V_{GE}=15V, V_{CE}=400V, di/dt=200A/\mu s$ )



**Fig 22: Diode Reverse Recovery Time and Softness Factor vs. Conduction Current**  
( $V_{GE}=15V, V_{CE}=400V, di/dt=200A/\mu s$ )

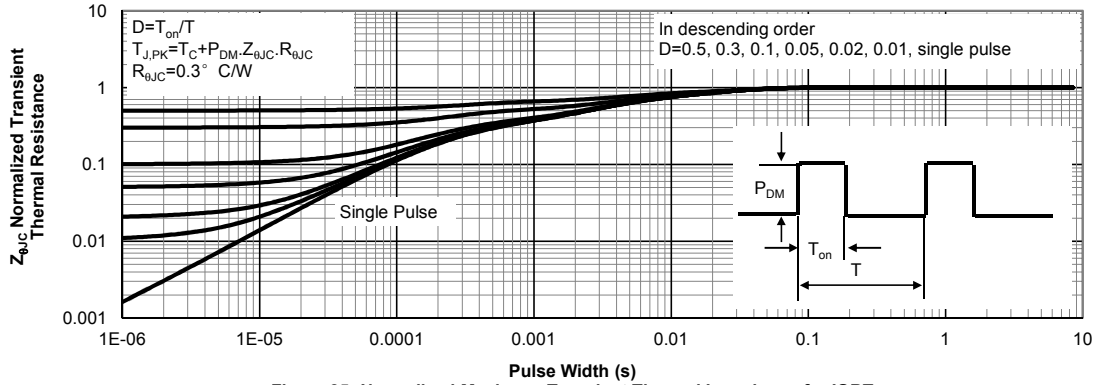


**Fig 23: Diode Reverse Recovery Charge and Peak Current vs. di/dt**  
( $V_{GE}=15V, V_{CE}=400V, I_f=60A$ )

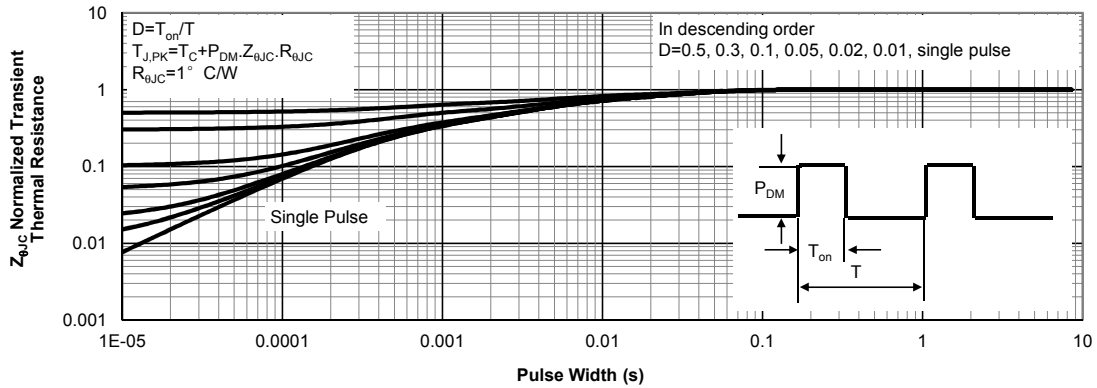


**Fig 24: Diode Reverse Recovery Time and Softness Factor vs. di/dt**  
( $V_{GE}=15V, V_{CE}=400V, I_f=60A$ )

**TYPICAL ELECTRICAL AND THERMAL CHARACTERISTICS**

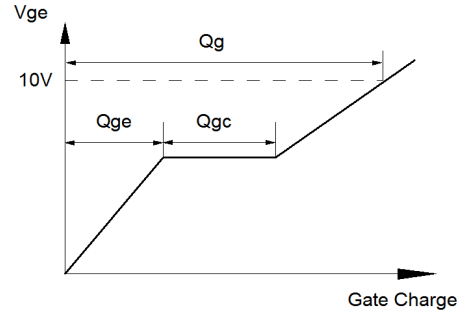
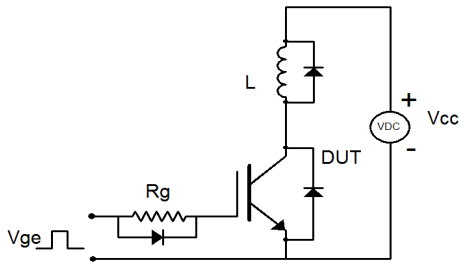


**Figure 25: Normalized Maximum Transient Thermal Impedance for IGBT**

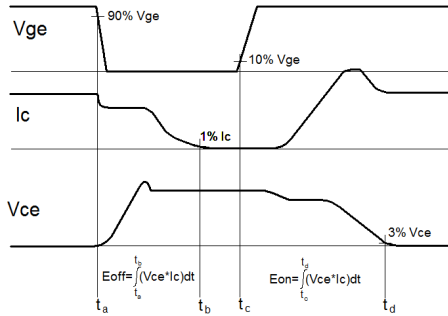
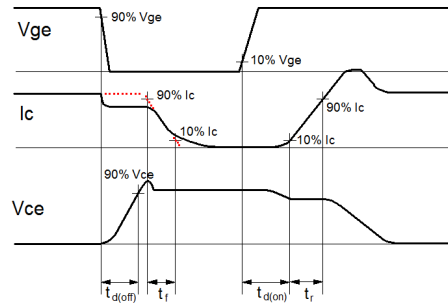
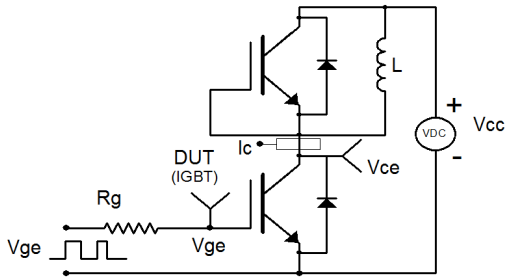


**Figure 26: Normalized Maximum Transient Thermal Impedance for Diode**

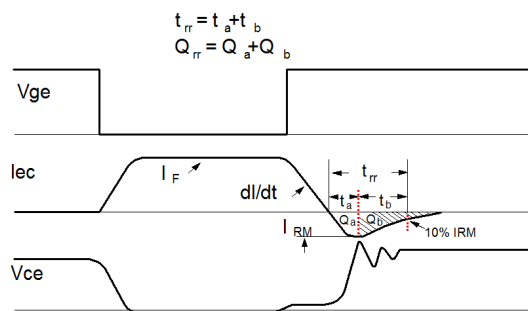
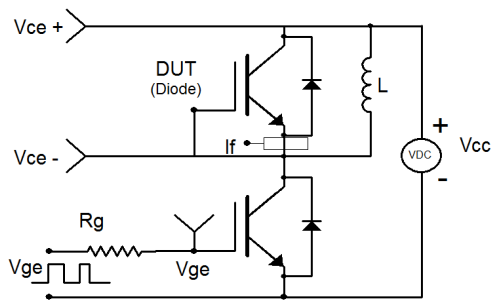
Gate Charge Test Circuit & Waveform



Inductive Switching Test Circuit & Waveforms



Diode Recovery Test Circuit & Waveforms



## Looking for pricing, stock, or lifecycle information?

Click below to explore more details on WIN SOURCE:

- ⊖ [View AOK60B65M3 on WIN SOURCE](#)
- ⊖ [Alpha & Omega Semiconductor Inc. Information](#)

## Optimize Your Supply Chain with WIN SOURCE Solutions

- ✓ Global Sourcing Solution
- ✓ Obsolete Management
- ✓ Cost Control Management
- ✓ Shortage Management
- ✓ Alternative Solution
- ✓ Excess Inventory Management