



**THE DATASHEET OF
ACMD-7617-TR1**



ACMD-7617

UMTS Band 1 Duplexer



Data Sheet

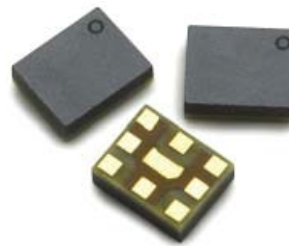

Description

The Avago ACMD-7617 is a highly miniaturized duplexer designed for use in Digital Enhanced Cordless Telecommunications (DECT) applications operating in UMTS Band 1 (1920 – 1980 MHz UL, 2110 – 2170 MHz DL).

Low Insertion Loss in the Tx channel minimizes current drain from the power amplifier, while low Rx channel Insertion Loss improves receiver sensitivity.

The ACMD-7617 enhances the sensitivity and dynamic range of handset receivers by providing high isolation of the transmitted signal from the receiver input and high rejection of transmit-generated noise in the receive band.

The ACMD-7617 is designed with Avago Technologies' innovative Film Bulk Acoustic Resonator (FBAR) technology, which makes possible ultra-small, high-Q filters at a fraction of their usual size. The excellent power handling capability of FBAR bulk-mode resonators supports the high output power levels used in mobile communications applications, while adding virtually no distortion.

The ACMD-7617 also utilizes Avago Technologies' advanced Microcap bonded-wafer, chip scale packaging technology. This process allows the filters to be assembled into a molded chip-on-board module with an overall size of only 2.0 x 2.5 mm and maximum height of 0.95 mm. The ACMD-7617 is compatible with standard 2.0 x 2.5 mm duplexer PCB footprints.

Functional Block Diagram

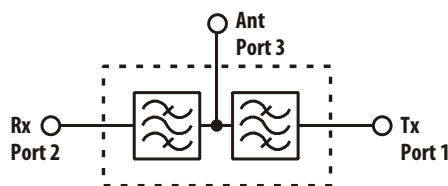

Features

- Miniature Size
 - 2.0 x 2.5 mm Max size
 - 0.95 mm Max Height
 - Standard 2 x 2.5 mm PCB footprint
- High Power Rating
 - 30 dBm Abs Max Tx Power in Tx Band
- Environmental
 - RoHS 6 Compliant
 - Halogen free
 - TBBPA Free

Specifications

- Rx Band Performance, -20 to +90° C
 - Insertion Loss: 2.2 dB Max
 - Rx Noise Blocking: 50 dB Min
- Tx Band Performance, -20 to +90° C
 - Insertion Loss: 2.5 dB Max
 - Tx Interferer Blocking: 55 dB Min

Applications

Digital Enhanced Cordless Telecommunications (DECT) systems operating in the UMTS Band 1 frequency range.

ACMD-7617 Electrical Specifications [2], $Z_0 = 50 \Omega$, T_C [1] as indicated

Symbol	Parameter	Units	-20° C		+25° C			+90° C	
			Min	Max	Min	Typ [3]	Max	Min	Max
Antenna Port to Receive Port									
S23	Insertion Loss in Receive Band (2110 – 2170 MHz)	dB		2.2		1.4	2.2		2.2
S22	Return Loss (SWR) of Receive Port in Receive Band (2110 – 2170 MHz)	dB	9	(2.1)	9	20 (1.2)	(2.1)	9	(2.1)
S23	Attenuation, 10 – 1920 MHz	dB	30		30	38		30	
S23	Attenuation in Transmit Band (1920 – 1980 MHz)	dB	48		48	67		48	
S23	Attenuation, 1980 – 2025 MHz	dB	35		35	50		35	
S23	Attenuation, 2255 – 2400 MHz	dB	30		30	50		30	
S23	Attenuation in Bluetooth Band (2400 – 2483.5 MHz)	dB	35		35	55		35	
S23	Attenuation, 4030 – 4150 MHz	dB	15		15	31		15	
S23	Attenuation, 5950 – 6130 MHz	dB	15		15	20		15	
Transmit Port to Antenna Port									
S31	Insertion Loss in UMTS Tx Channel Center [4]	dB							
	1922.4 MHz			2.5		1.9	2.3		2.3
	1924.4 MHz			2.3		1.5	2.1		2.1
	1926.4 – 1971.6 MHz			2.1		1.3	2.0		2.0
	1973.6 MHz			2.0		1.3	2.0		2.1
	1975.6 MHz			2.0		1.3	2.0		2.3
	1977.6 MHz			2.0		1.3	2.0		2.5
S11	Return Loss (SWR) of Transmit Port in Transmit Band (1920 – 1980 MHz)	dB	9	(2.1)	9	20 (1.2)	(2.1)	9	(2.1)
S31	Attenuation, 10 – 1574 MHz	dB	30		30	45		30	
S31	Attenuation in GPS Rx Band (1574.42 – 1576.42 MHz)	dB	35		35	38		35	
S31	Attenuation, 1800 – 1900 MHz	dB	27		27	41		27	
S31	Attenuation, 2010 – 2025 MHz	dB	28		28	52		28	
S31	Attenuation in Receive Band (2110 – 2170 MHz)	dB	45		45	51		45	
S31	Attenuation in Bluetooth Band (2400 – 2483.5 MHz)	dB	30		30	38		30	
S31	Attenuation in Transmit 2 nd Harmonic Band (3840 – 3960 MHz)	dB	30		30	39		30	
S31	Attenuation in Transmit 3 rd Harmonic Band (5760 – 5940 MHz)	dB	5		5	16		5	
Antenna Port									
S33	Return Loss (SWR) of Ant Port in Rx Band (2110 – 2170 MHz)	dB	9	(2.1)	9	21 (1.2)	(2.1)	9	(2.1)
S33	Return Loss (SWR) of Ant Port in Tx Band (1920 – 1980 MHz)	dB	9	(2.1)	9	20 (1.2)	(2.1)	9	(2.1)
Isolation Transmit Port to Receive Port									
S21	Tx-Rx Isolation in Receive Band (2110 – 2170 MHz)	dB	50		50	61		50	
S21	Tx-Rx Isolation in Transmit Band (1920 – 1980 MHz)	dB	55		55	64		55	

Notes:

- T_C is the case temperature and is defined as the temperature of the underside of the Duplexer where it makes contact with the circuit board.
- Min/Max specifications are guaranteed at the indicated temperature with the input power to the Tx port equal to or less than +29 dBm over all Tx frequencies unless otherwise noted.
- Typical data is the average value of the parameter over the indicated band at the specified temperature. Typical values may vary over time.
- Integrated Insertion Loss over 3.8 MHz UMTS channel(s).

Absolute Maximum Ratings^[1]

Parameter	Unit	Value
Storage temperature	°C	-65 to +125
Maximum RF Input Power to Tx Port		
1920–1980 MHz	dBm	+30
All other frequencies		+25

Maximum Recommended Operating Conditions^[2]

Parameter	Unit	Value
Operating temperature, T _c ^[3]	°C	-40 to +100
Maximum CW RF Input Power to Tx Port		
1920–1980 MHz	dBm	+28
All other frequencies		+23

Notes:

1. Operation in excess of any one of these conditions may result in permanent damage to the device.
2. The device will function over the recommended range without degradation in reliability or permanent change in performance, but is not guaranteed to meet electrical specifications.
3. T_c is defined as case temperature, the temperature of the underside of the duplexer where it makes contact with the circuit board.

ACMD-7617 Typical Performance at $T_c = 25^\circ\text{C}$

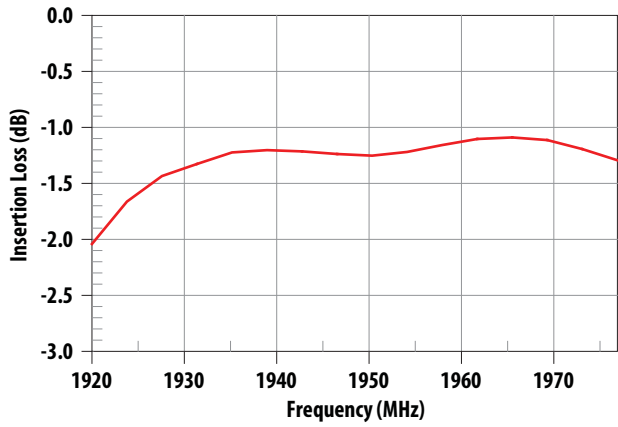

Figure 1. Tx-Ant Insertion Loss

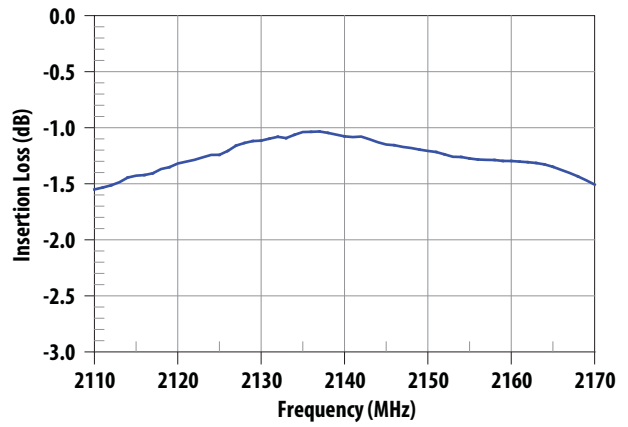

Figure 2. Ant-Rx Insertion Loss

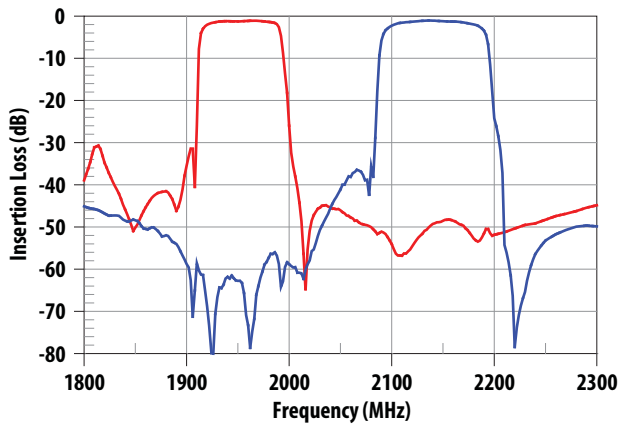

Figure 3. Tx Rejection in Rx Band and Rx Rejection in Tx Band

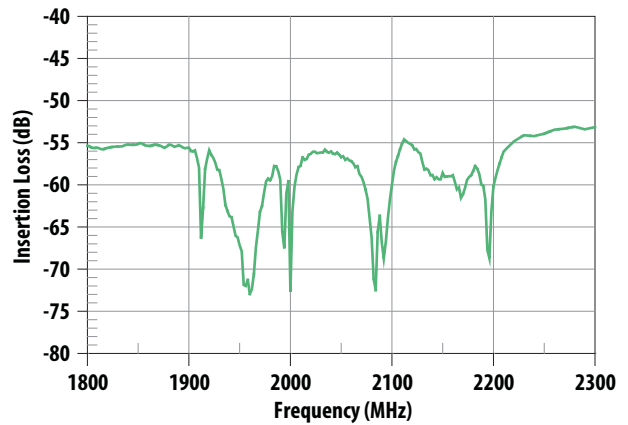

Figure 4. Tx-Rx Isolation

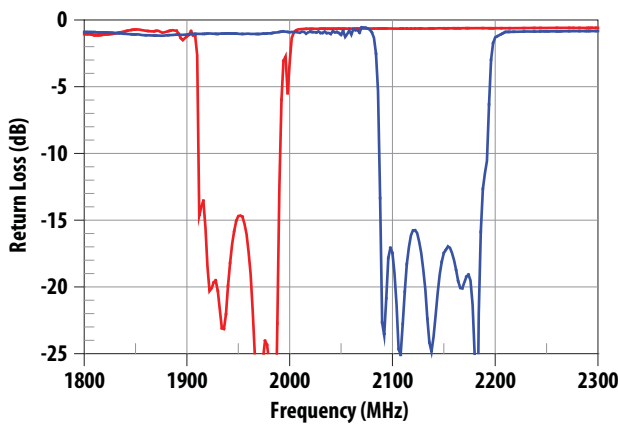

Figure 5. Tx and Rx Port Return Loss

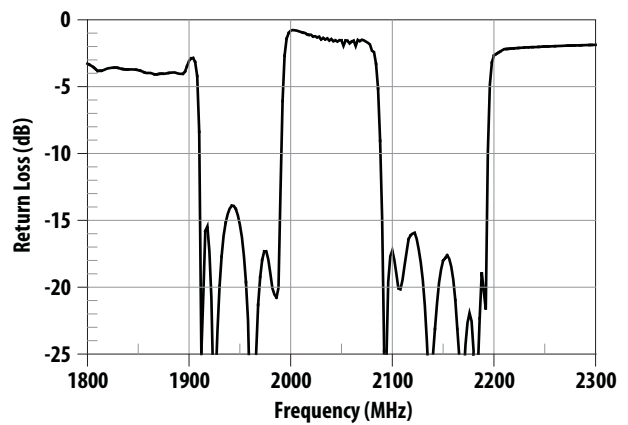

Figure 6. Antenna Port Return Loss

ACMD-7617 Typical Performance at $T_C = 25^\circ\text{C}$

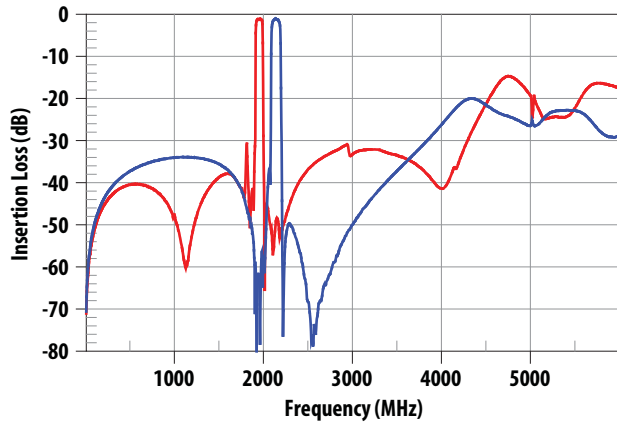

Figure 7. Tx-Ant and Ant-Rx Wideband Insertion Loss

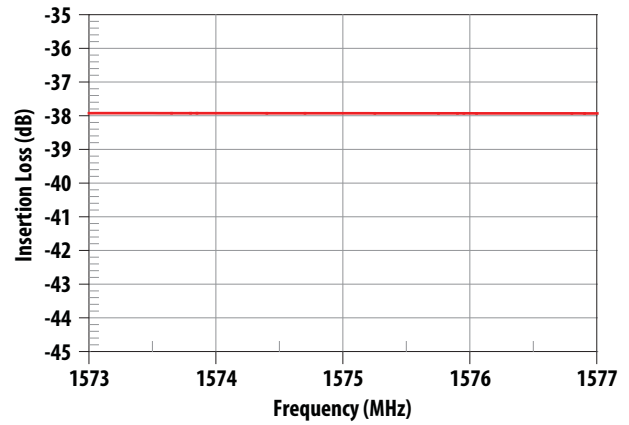

Figure 8. Tx-Ant Rejection in GPS Band

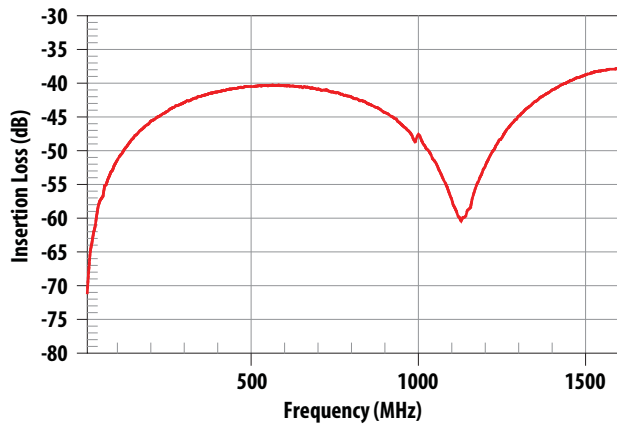

Figure 9. Tx-Ant Low Frequency Rejection

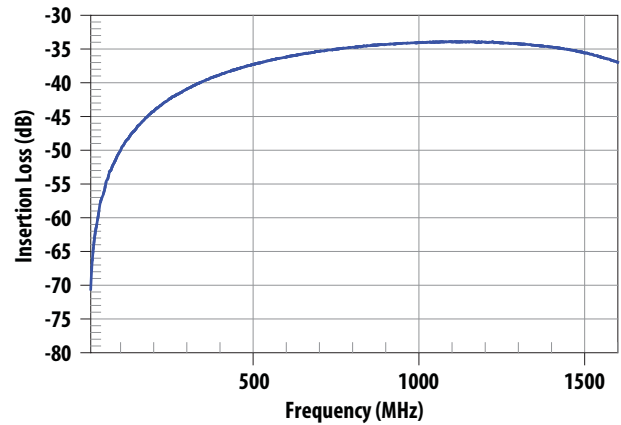

Figure 10. Ant-Rx Low Frequency Rejection

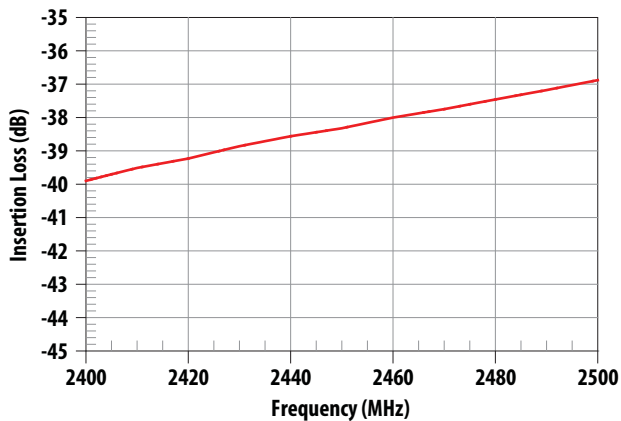

Figure 11. Tx-Ant Rejection in Bluetooth Band

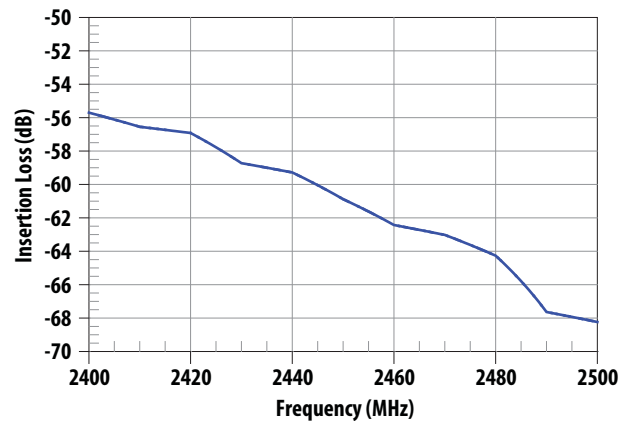

Figure 12. Ant-Rx Rejection in Bluetooth Band

ACMD-7617 Typical Performance at $T_c = 25^\circ\text{C}$

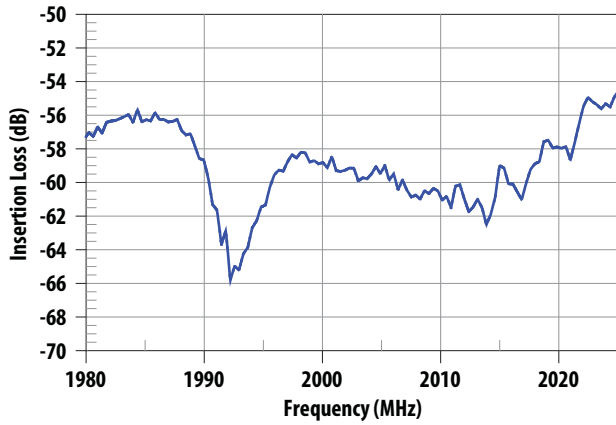

Figure 13. Ant-Rx Rejection, 1980 –2025 MHz

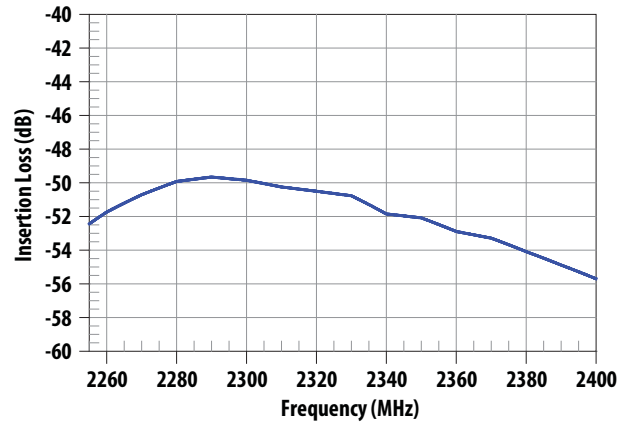

Figure 14. Ant-Rx Rejection, 2255 –2400 MHz

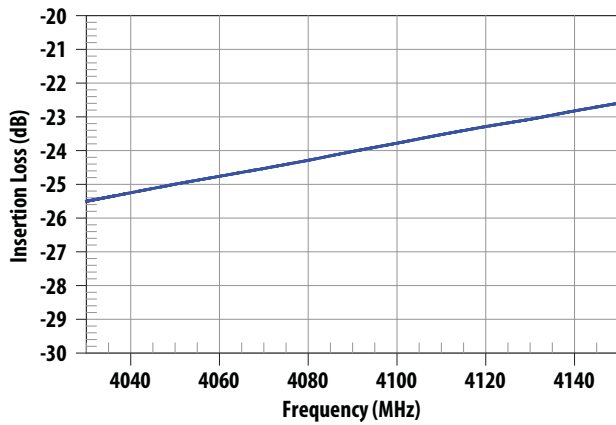

Figure 15. Ant-Rx Rejection, 4030 –4150 MHz

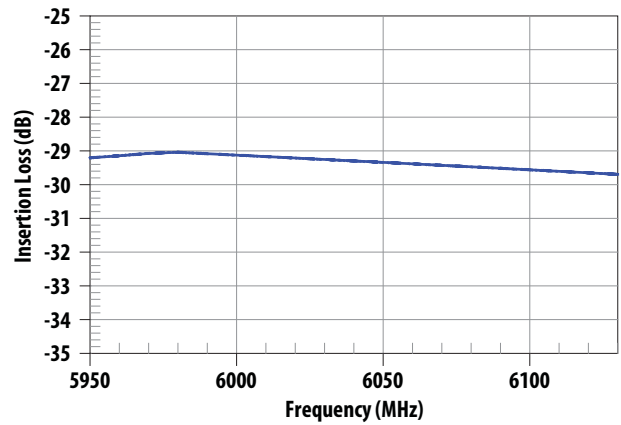

Figure 16. Ant-Rx Rejection, 5950 –6130 MHz

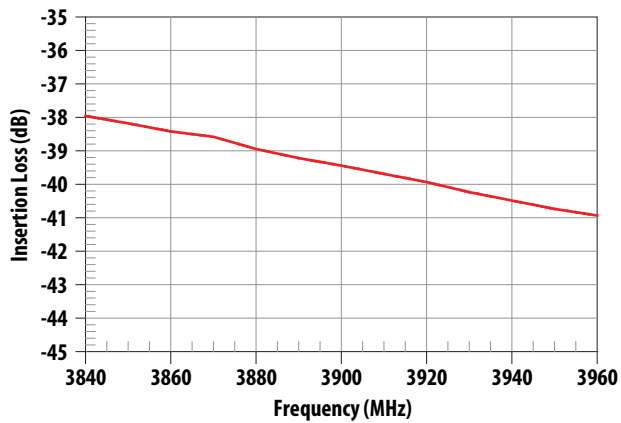

Figure 17. Tx-Ant Rejection at Tx Second Harmonic

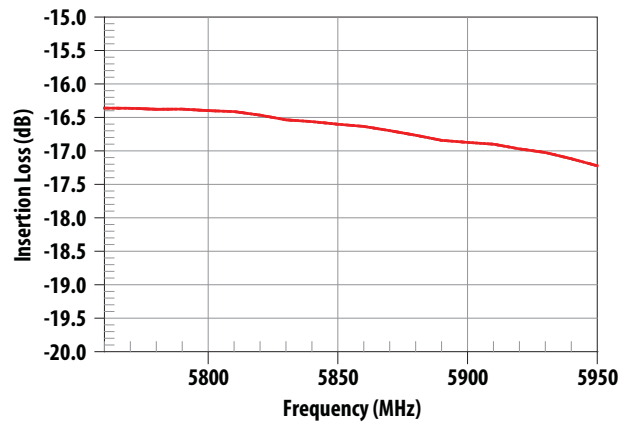

Figure 18. Tx-Ant Rejection at Tx Third Harmonic

ACMD-7617 Typical Performance at $T_c = 25^\circ\text{C}$

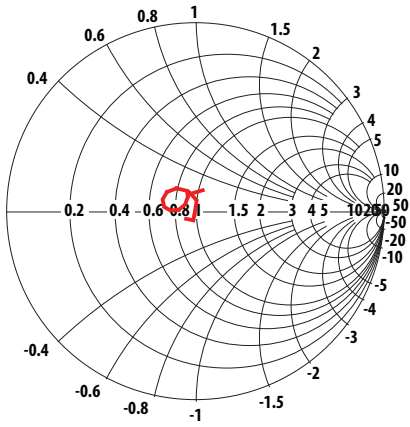

Figure 19. Tx Port Impedance in Tx Band

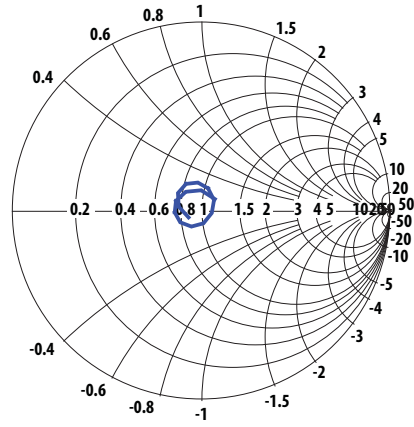

Figure 20. Rx Port Impedance in Rx Band

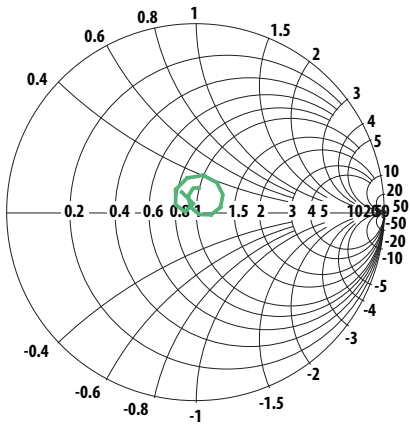

Figure 21. Ant Port Impedance in Tx Band

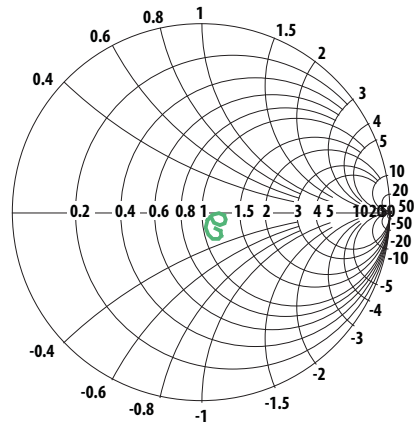
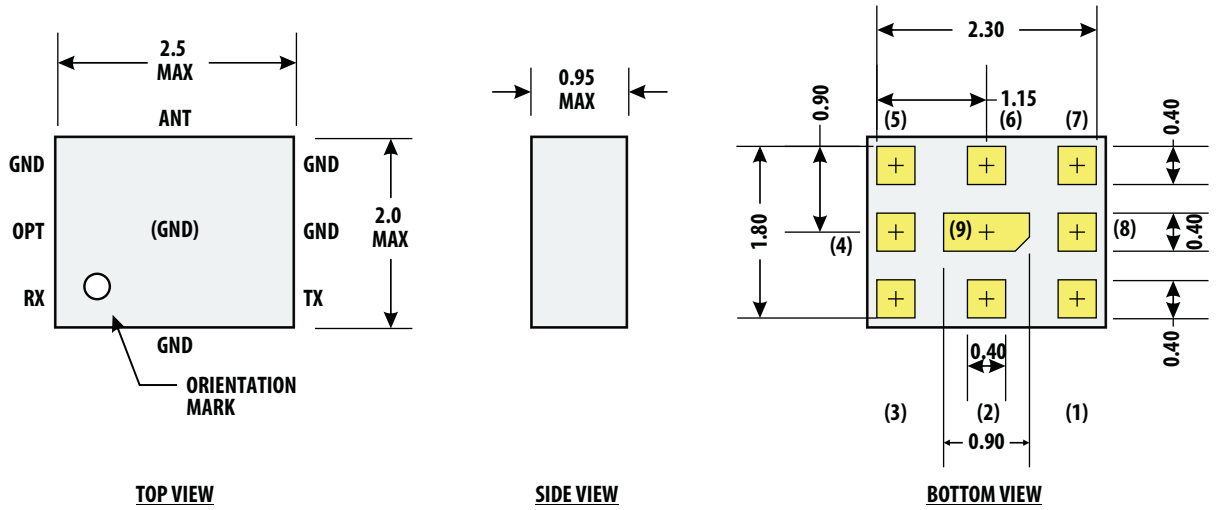

Figure 22. Ant Port Impedance in Rx Band

ACMD-7617



Notes:

1. Dimensions in millimeters
Tolerance: X.X ± 0.1 mm
X.XX ± 0.05 mm
2. Dimensions nominal unless otherwise noted
3. Angles 45° nominal
4. I/O Pads (3 ea)
Size: 0.40 X 0.40 mm
Spacing to ground metal: 0.30 mm
5. Contact areas are gold plated

Pin Connections:

- | | |
|---------------|----------------------------|
| 1 | Rx (or Rx(+)) |
| 2, 4, 5, 7, 9 | Gnd |
| 3 | Tx |
| 6 | Ant |
| 8 | Optional: Gnd, NC or Rx(-) |

Figure 23. Package Outline Drawing

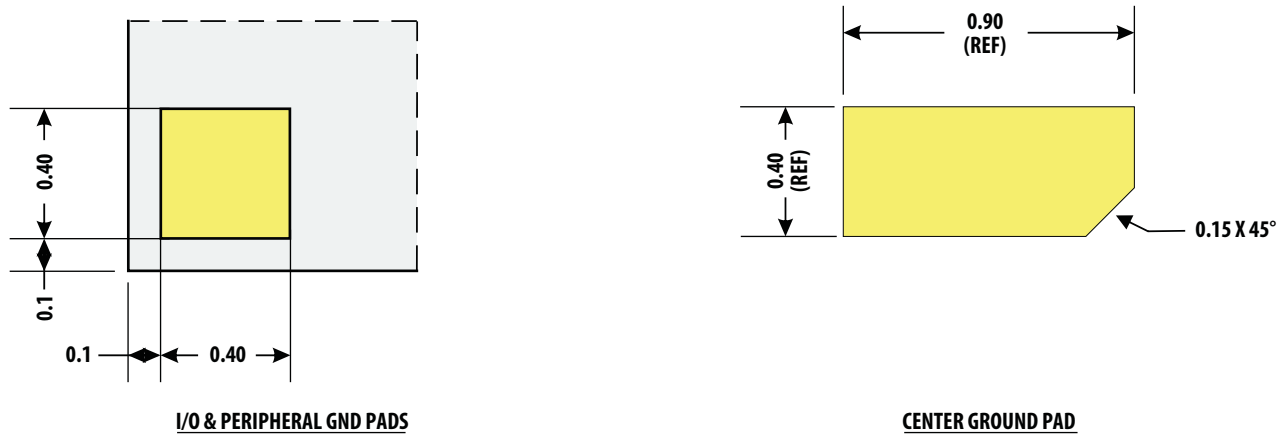

Figure 24. Pad Detail

ACMD-7617

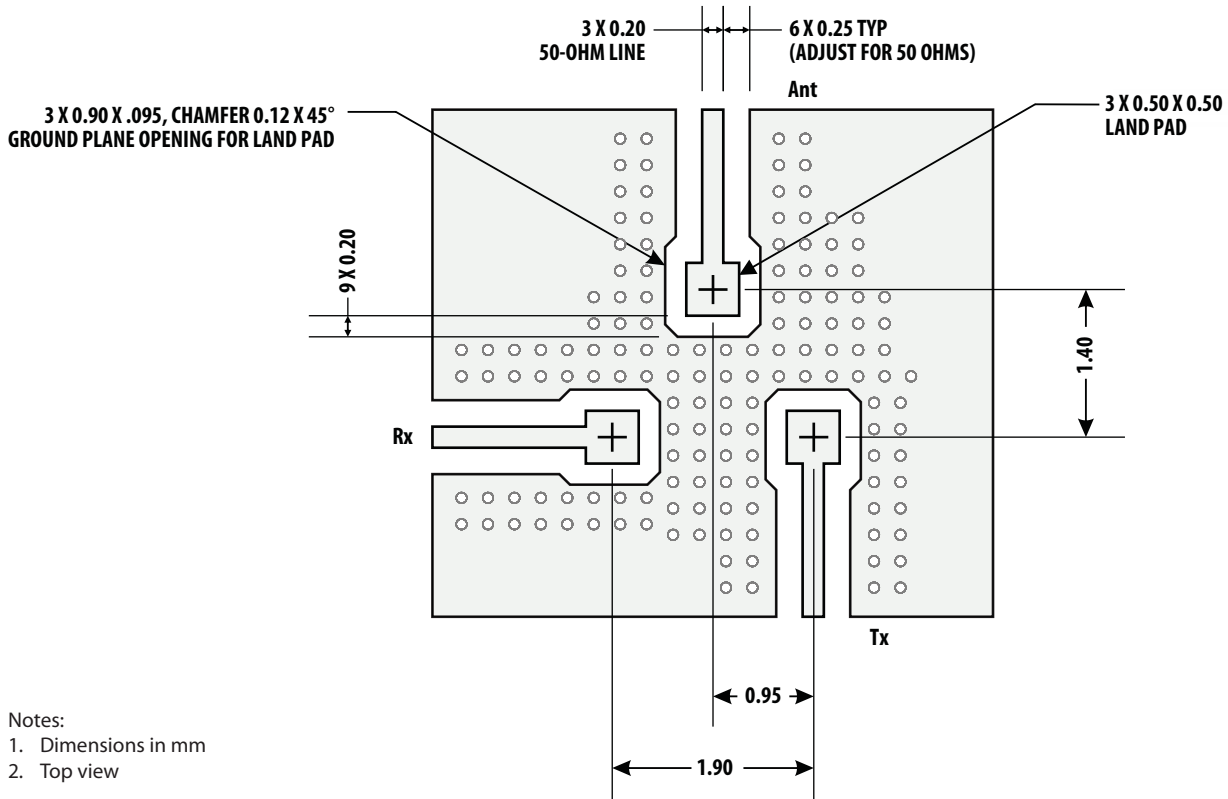

Figure 25. Suggested PCB Layout

A PCB layout using the principles illustrated in the figure above is recommended to optimize performance of the ACMD-7617.

Note: Pin 8 grounded in this example.

The transmission line dimensions shown are designed to achieve an impedance of 50 ohms for an 80 μm thick PCB layer with a dielectric constant of 3.4. If other PCB materials or thicknesses are used, the 0.25 mm gap spacing may need to be adjusted to retain a Zo of 50 ohms.

It is important to maximize isolation between the Tx and Rx ports.

High isolation is achieved by: (1) maintaining a continuous ground plane around the I/O connections and duplexer mounting area, and (2) surrounding the I/O ports with sufficient ground vias to enclose the connections in a “Faraday cage.”

The ground vias under the ACMD-7617 mounting area are also needed to provide adequate heat sinking for the device.

ACMD-7617

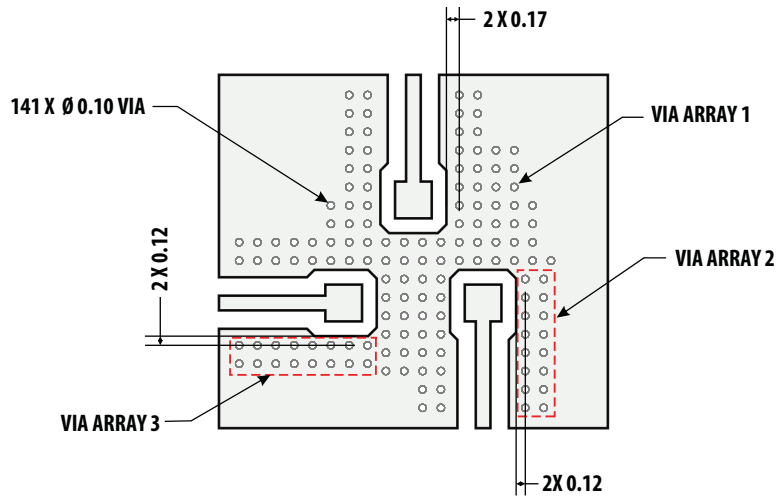

- Notes:
1. Dimensions in mm
 2. Top view
 3. Via arrays: horiz pitch = 0.25, vert pitch = 0.25

Figure 26. PCB Layout, Via Detail

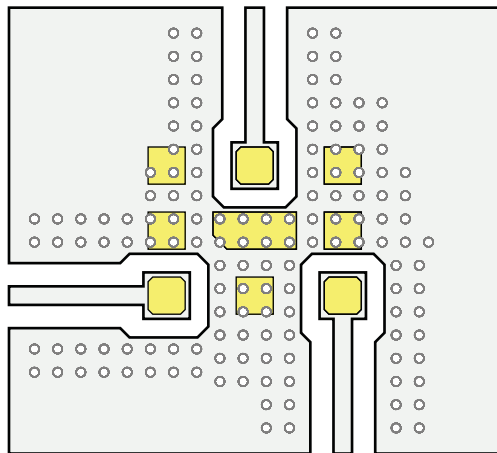

- Note:
1. Top view

Figure 27. ACMD-7617 Superposed on PCB Layout

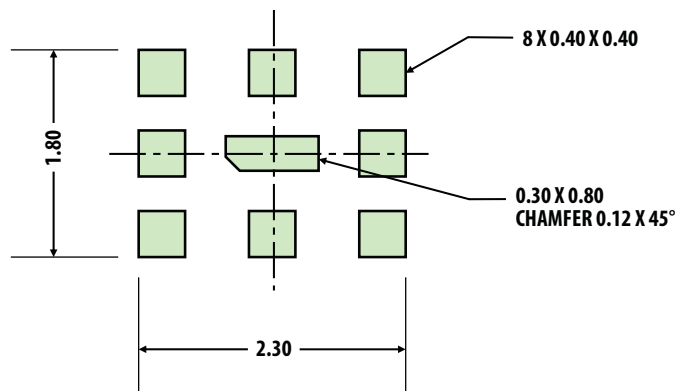

- Notes:
1. Dimensions in mm
 2. Top view
 3. Chamfer or radius all corners 0.05 mm min

Figure 28. Recommended Solder Stencil

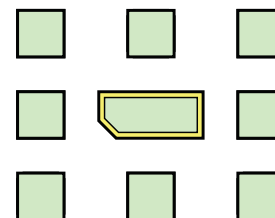

- Notes:
1. Top view
 2. Peripheral clearance of stencil aperture for center device pad is 0.05 mm. All other apertures match device pad 1:1

Figure 29. Solder Stencil Superposed on ACMD-7617

ACMD-7617

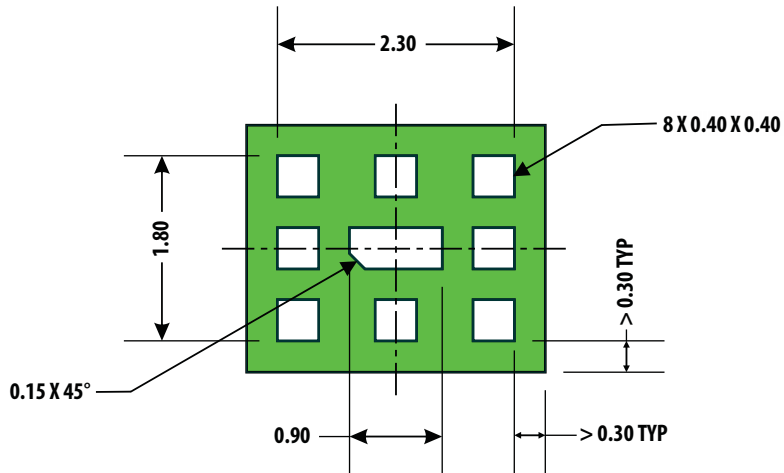

- Notes:
1. Dimensions in mm
 2. Top view

Figure 30. Recommended Solder Mask

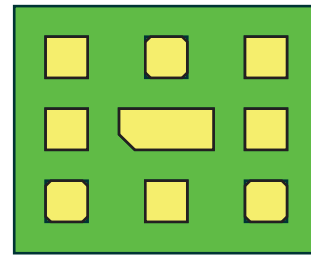

- Notes:
1. Top view
 2. Mask apertures match device pads 1:1

Figure 31. Solder Mask Superposed on ACMD-7617

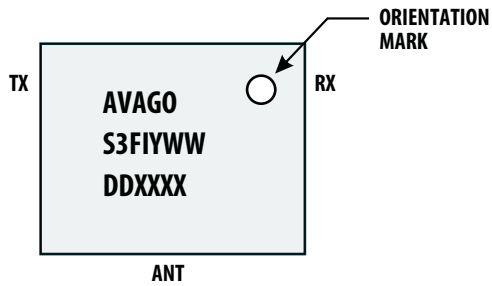

- S = ACMD-7617
- FI = Mfg Information
- Y = Year
- WW = Work Week
- DD = Date Code
- XXXX = Assembly Lot

Figure 32. Product Marking and Pin Orientation

ACMD-7617

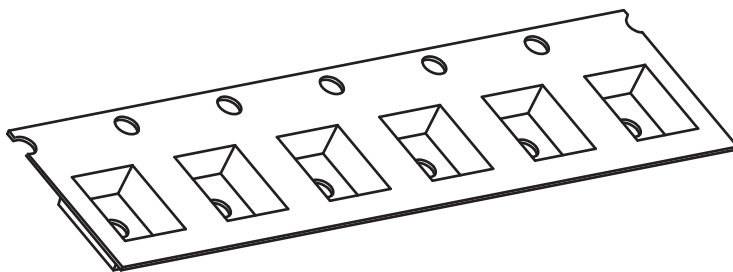
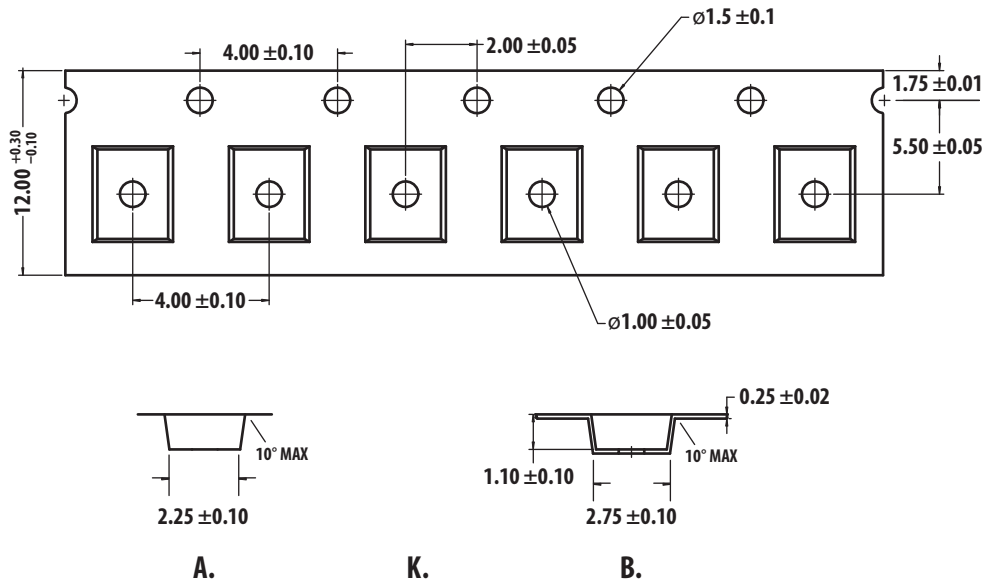

Figure 33. SMD Tape Packing

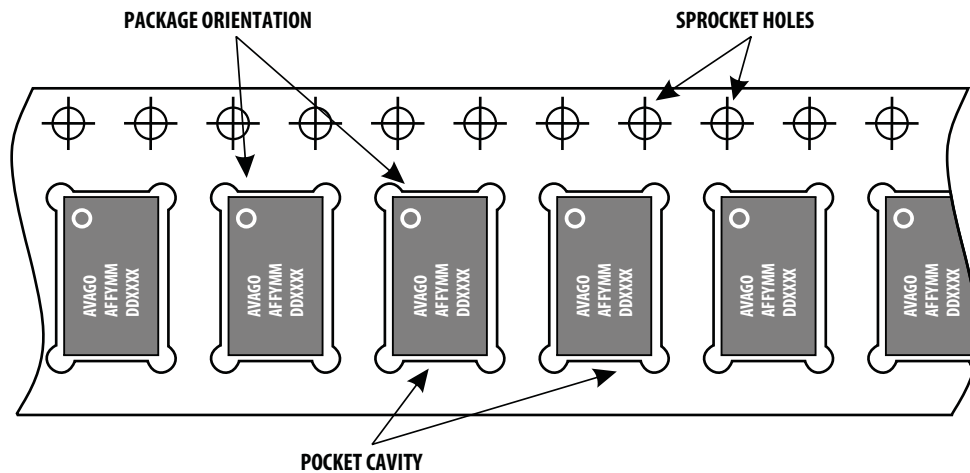

Figure 34. Unit Orientation in SMT Tape

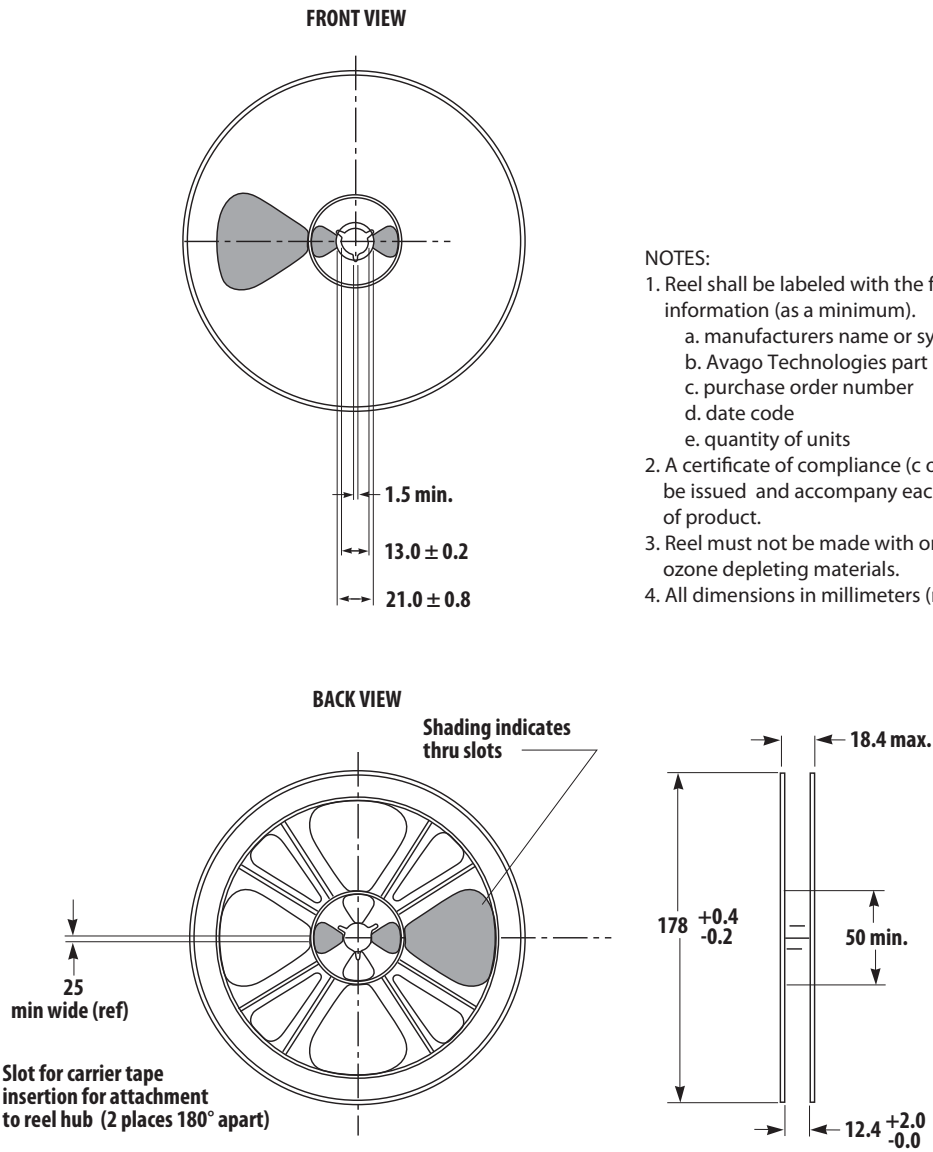

Figure 35. SMT Reel Drawing

ACMD-7617

Package Moisture Sensitivity

Feature	Test Method	Performance
Moisture Sensitivity Level (MSL) at 260° C	JESD22-A113D	Level 3

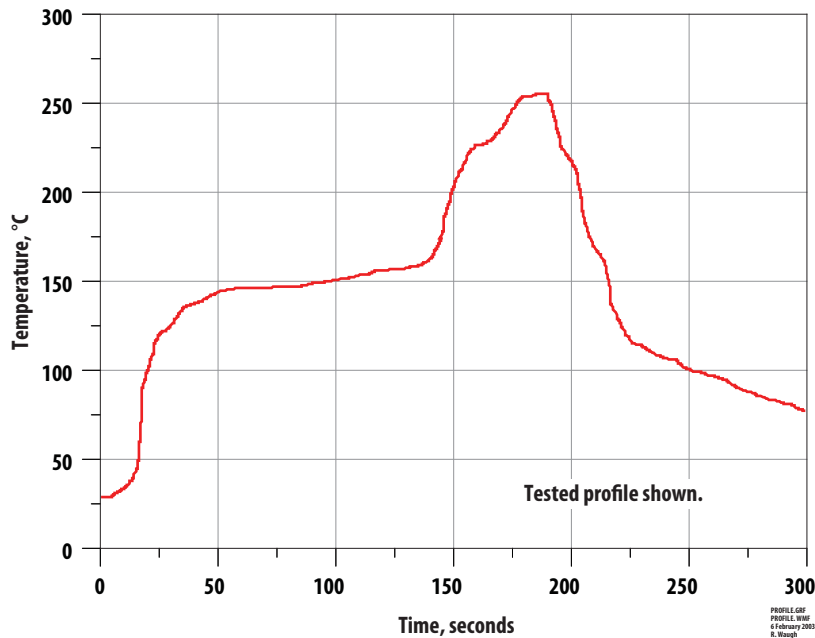

Figure 36. Verified SMT Solder Profile

Ordering Information

Part Number	No. of Devices	Container
ACMD-7617-BLK	100	Tape Strip or Anti-static Bag
ACMD-7617-TR1	3000	178 mm (7-inch) Reel

For product information and a complete list of distributors, please go to our web site: www.avagotech.com

Avago, Avago Technologies, and the A logo are trademarks of Avago Technologies in the United States and other countries. Data subject to change. Copyright © 2005-2011 Avago Technologies. All rights reserved.
AV02-2912EN - May 26, 2011

AVAGO
TECHNOLOGIES

Looking for pricing, stock, or lifecycle information?

Click below to explore more details on WIN SOURCE:

 [View ACMD-7617-TR1 on WIN SOURCE](#)

 [Broadcom Limited Information](#)

Optimize Your Supply Chain with WIN SOURCE Solutions

-  Global Sourcing Solution
-  Obsolete Management
-  Cost Control Management
-  Shortage Management
-  Alternative Solution
-  Excess Inventory Management