



**THE DATASHEET OF
AAT2430AIDX-T1**



Sixteen-Channel White LED Driver Solution with LED Current and Timing Control**General Description**

The AAT2430A is a highly integrated, high efficiency white LED backlight solution for large size LCD panels used in LCD TVs. By controlling external power MOSFETs (such as the Skyworks' AAT2491 high-voltage TrenchDMOS array), the AAT2430A facilitates 16 current sink channels to provide precision, constant-current drive for strings of white LEDs, where the number of series-connected LEDs per string is only limited by the system LED voltage supply. Current in each backlight string and string-to-string matching is controlled using I-Precise™ sensing and control circuitry, a novel on-chip method to accurately control drain current in external discrete power MOSFETs independent of their construction and without the need for precision sense resistors.

A 15MHz SPI compatible interface allows fast, independent digital control of each current sink. Full scale LED current is programmed using an external resistor. DOT correction may be applied globally to all sink channels with 8-bit resolution. Both phase delay and grayscale clock (GS Clock) PWM on-time are user programmable with 12-bit resolution for each current sink channel. Timing and synchronization are determined by externally applied V_{SYNC} and GS Clock signals.

The AAT2430A provides latched fault handling and fault reporting through the SPI interface and fault flag output pin. The fault detection system reports open or short circuit LED strings and over-temperature events. The short circuit LED detection threshold is user programmable.

The LED string supply voltage may be regulated by using the voltage or current mode current sense feedback signal to the LED voltage regulator. This analog signal represents the highest V_F string of LEDs. Thermal protection circuitry shuts down the device in the event of an over-temperature condition.

The AAT2430A is available in the Pb-free, thermally enhanced 64-pin 9mm x 9mm QFN and 64-pin 14mm x 14mm LQFP packages.

Features

- V_{IN} Range: 10.8V – 28V
- 16 Programmable LED Current Sinks
 - ±1.5% Accuracy @ 25°C
 - ±1.5% Matching @ 25°C
- SPI Interface
 - Digitally Programmable Individual Channels
 - Up to 15MHz Clock Speed
 - Read/Write Registers
- High Resolution Digital Control for Individual Channels
 - 12-Bit Resolution Grayscale PWM Brightness
 - 12-Bit Resolution Channel Phase Delay
 - 8-Bit Resolution Global Current Setting (Dot Correction)
- V_{SYNC} PWM and Delay Synchronization
- Integrated Fault Protection
 - Open Circuit LED(s)
 - Programmable Short LED Threshold
 - Over-Temperature Protection
- 3D Feedback Function
- 9mm x 9mm 64-pin QFN Package with 0.5mm pitch or 14mm x 14mm 64-pin Low Profile QFP Package with 0.8mm pitch

Applications

- Large Size LCD TVs, Panels
- White LED Backlight, Dynamic Edge LCD TV Backlight

AAT2430A

Sixteen-Channel White LED Driver Solution with LED Current and Timing Control

Ordering Information

Package	Marking ¹	Part Number (Tape and Reel) ²
QFN99-64	W6XYY	AAT2430AIDX-T1
LQFP1414-64	XXYY 2430A	AAT2430AISX-T1



Skyworks Green™ products are compliant with all applicable legislation and are halogen-free.

For additional information, refer to *Skyworks Definition of Green™*, document number SQ04-0074.

Package Information

Dimensions subject to change without notice.

QFN99-64

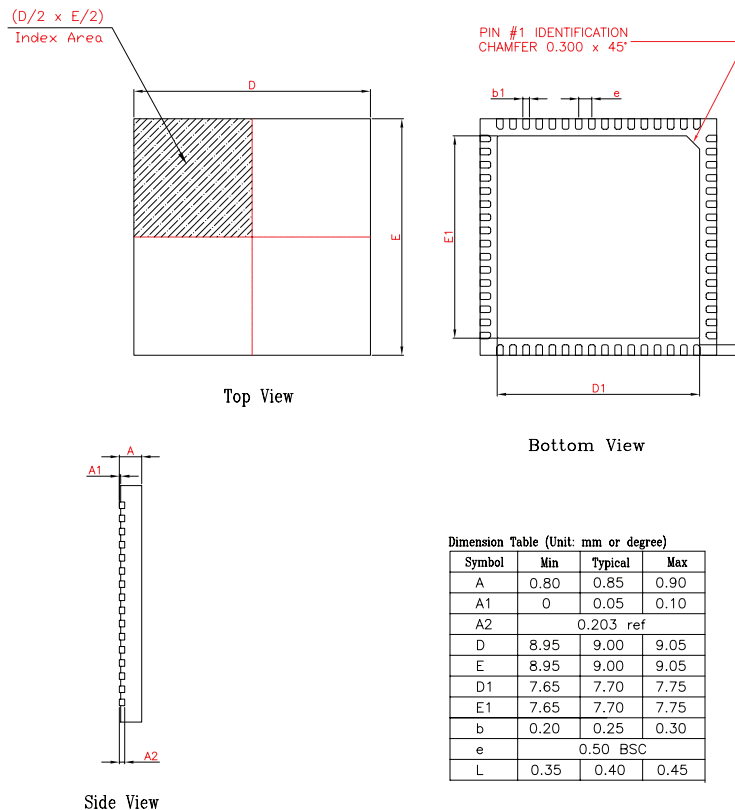

All dimensions in millimeters.

1. XYY, XXYY = assembly and date code.
 2. Sample stock is generally held on part numbers listed in **BOLD**.
 3. The leadless package family, which includes QFN, TQFN, DFN, TDFN and STDFN, has exposed copper (unplated) at the end of the lead terminals due to the manufacturing process. A solder fillet at the exposed copper edge cannot be guaranteed and is not required to ensure a proper bottom solder connection.

AAT2430A

Sixteen-Channel White LED Driver Solution with LED Current and Timing Control

LQFP1414-64

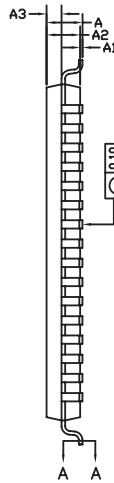
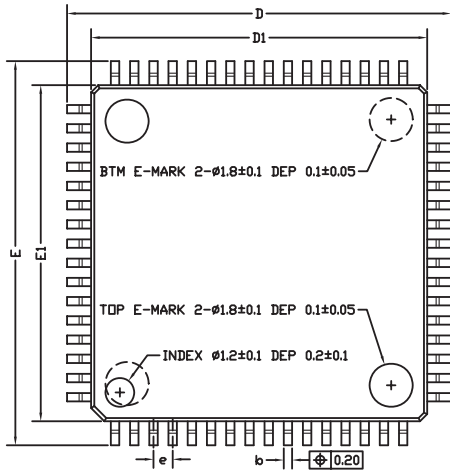

SYMBOL	MIN	NOM	MAX
A	—	—	1.60
A1	0.05	—	0.15
A2	1.35	1.40	1.45
A3	0.59	0.64	0.69
b	0.31	—	0.44
b1	0.30	0.35	0.40
c	0.13	—	0.18
c1	0.12	0.127	0.134
D	15.80	16.00	16.20
D1	13.90	14.00	14.10
E	15.80	16.00	16.20
E1	13.90	14.00	14.10
e	0.70	0.80	0.90
L	0.45	0.60	0.75
L1	1.00REF		
L2	0.25BSC		
R1	0.08	—	—
R2	0.08	—	0.20
S	0.20	—	—
θ	0°	3.5°	7°
$\theta 1$	0°	—	—
$\theta 2$	11°	12°	13°
$\theta 3$	11°	12°	13°

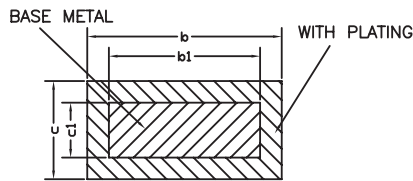

Section A-A

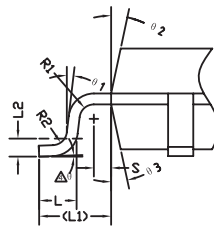

NOTES:

ALL DIMENSIONS MEET JEDEC STANDARD MS-026 BEB DO NOT INCLUDE MOLD FLASH OR PROTRUSIONS.

All dimensions in millimeters.

Copyright © 2012 Skyworks Solutions, Inc. All Rights Reserved.

Information in this document is provided in connection with Skyworks Solutions, Inc. ("Skyworks") products or services. These materials, including the information contained herein, are provided by Skyworks as a service to its customers and may be used for informational purposes only by the customer. Skyworks assumes no responsibility for errors or omissions in these materials or the information contained herein. Skyworks may change its documentation, products, services, specifications or product descriptions at any time, without notice. Skyworks makes no commitment to update the materials or information and shall have no responsibility whatsoever for conflicts, incompatibilities, or other difficulties arising from any future changes.

No license, whether express, implied, by estoppel or otherwise, is granted to any intellectual property rights by this document. Skyworks assumes no liability for any materials, products or information provided hereunder, including the sale, distribution, reproduction or use of Skyworks products, information or materials, except as may be provided in Skyworks Terms and Conditions of Sale.

THE MATERIALS, PRODUCTS AND INFORMATION ARE PROVIDED "AS IS" WITHOUT WARRANTY OF ANY KIND, WHETHER EXPRESS, IMPLIED, STATUTORY, OR OTHERWISE, INCLUDING FITNESS FOR A PARTICULAR PURPOSE OR USE, MERCHANTABILITY, PERFORMANCE, QUALITY OR NON-INFRINGEMENT OF ANY INTELLECTUAL PROPERTY RIGHT; ALL SUCH WARRANTIES ARE HEREBY EXPRESSLY DISCLAIMED. SKYWORKS DOES NOT WARRANT THE ACCURACY OR COMPLETENESS OF THE INFORMATION, TEXT, GRAPHICS OR OTHER ITEMS CONTAINED WITHIN THESE MATERIALS. SKYWORKS SHALL NOT BE LIABLE FOR ANY DAMAGES, INCLUDING BUT NOT LIMITED TO ANY SPECIAL, INDIRECT, INCIDENTAL, STATUTORY, OR CONSEQUENTIAL DAMAGES, INCLUDING WITHOUT LIMITATION, LOST REVENUES OR LOST PROFITS THAT MAY RESULT FROM THE USE OF THE MATERIALS OR INFORMATION, WHETHER OR NOT THE RECIPIENT OF MATERIALS HAS BEEN ADVISED OF THE POSSIBILITY OF SUCH DAMAGE.



Skyworks products are not intended for use in medical, lifesaving or life-sustaining applications, or other equipment in which the failure of the Skyworks products could lead to personal injury, death, physical or environmental damage. Skyworks customers using or selling Skyworks products for use in such applications do so at their own risk and agree to fully indemnify Skyworks for any damages resulting from such improper use or sale.

Customers are responsible for their products and applications using Skyworks products, which may deviate from published specifications as a result of design defects, errors, or operation of products outside of published parameters or design specifications. Customers should include design and operating safeguards to minimize these and other risks. Skyworks assumes no liability for applications assistance, customer product design, or damage to any equipment resulting from the use of Skyworks products outside of stated published specifications or parameters.

Skyworks, the Skyworks symbol, and "Breakthrough Simplicity" are trademarks or registered trademarks of Skyworks Solutions, Inc., in the United States and other countries. Third-party brands and names are for identification purposes only, and are the property of their respective owners. Additional information, including relevant terms and conditions, posted at www.skyworksinc.com, are incorporated by reference.

Looking for pricing, stock, or lifecycle information?

Click below to explore more details on WIN SOURCE:

-  [View AAT2430AIDX-T1 on WIN SOURCE](#)
-  [Skyworks Solutions Inc. Information](#)

Optimize Your Supply Chain with WIN SOURCE Solutions

-  Global Sourcing Solution
-  Obsolete Management
-  Cost Control Management
-  Shortage Management
-  Alternative Solution
-  Excess Inventory Management