

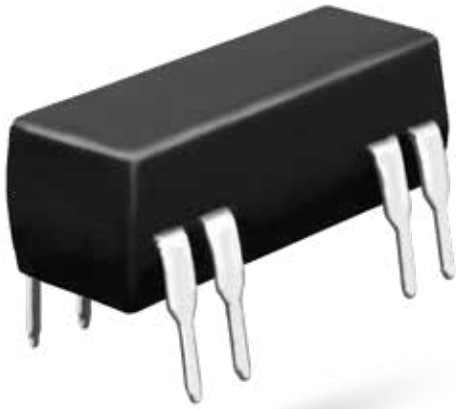

THE DATASHEET OF
8L02-05-10



8L SERIES/SPARTAN DIP REED RELAYS



8L Series Economy DIP Reed Relays

The Coto 8L Spartan Series relays combine Coto quality and economy in the industry standard 14 pin molded DIP package. This series will cross to all competitive DIP packages and is ideal for telecom, security, and other general purpose applications.

8L Series Features

- ▶ Drop-in low cost replacement for industry standard DIP packages
- ▶ Contact forms; 1A, 2A and 1C available
- ▶ Available coils in 5V, 12V and 24V
- ▶ Molded thermoset body on integral lead frame design
- ▶ Hermetically Sealed Contacts
- ▶ Optional Electrostatic Shield and Coil Suppression Diode
- ▶ UL File #E67117 - Contact factory for details
- ▶ RoHS compliant

DIMENSIONS

in Inches (Millimeters)

Model 8L01, 8L02 & 8L41

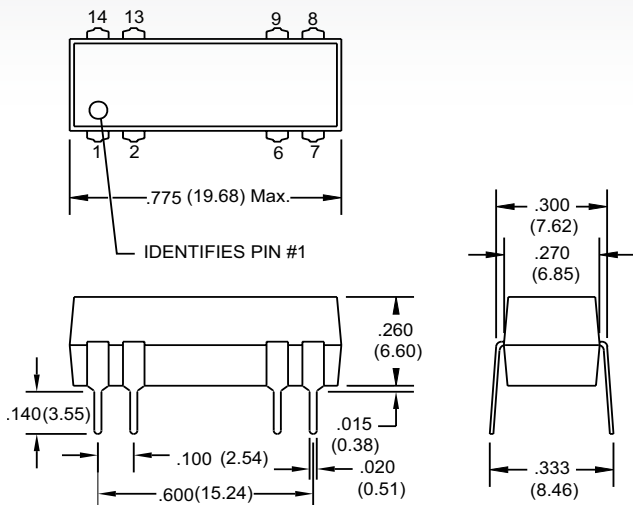

Model 8L61

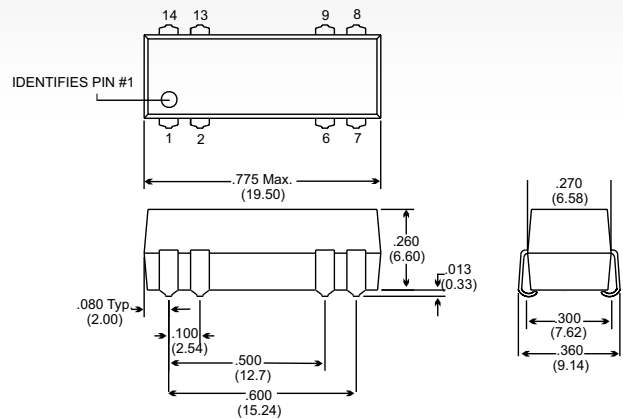

Alternate Package #1 for 8L01, 8L02 & 8L41

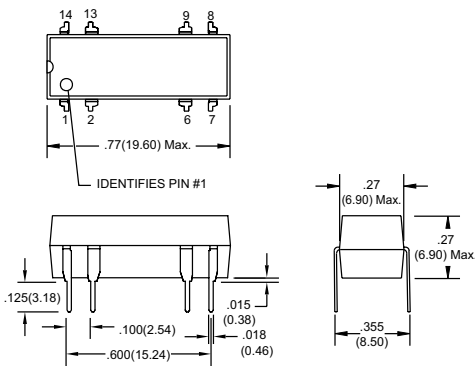

Alternate Package #2 for 8L01, 8L02 & 8L41

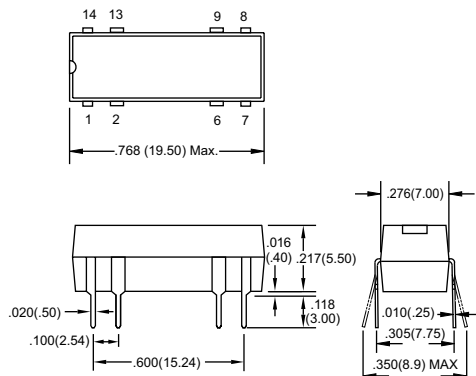

Ordering Information

Part Number	8LXX-XX-XX1
Model Number	8L01 8L41 8L61
Coil Voltage	05=5 volts 12=12 volts 24=24 volts
Diode Option³	0=No Diode 1=Diode
Shield Option⁴	0=No Shield 1=Electrostatic Shield

Ordering Information

Part Number	8LXX-XX-XX
Model Number	8L02
Coil Voltage	05=5 volts 12=12 volts 24=24 volts
Diode Option³	0=No Diode 1=Diode
Shield Option⁴	0=No Shield 1=Electrostatic Shield

06292019

MODEL NUMBER			8L01 ^{2,3,4}			8L02 ^{2,3,4}			8L41 ^{2,3,4}			8L61 ^{2,3,4,5}		
Parameters	Test Conditions	Units	1 Form A			2 Form A			1 Form C			1 Form C		
COIL SPECS.														
Nom. Coil Voltage		VDC	5	12	24	5	12	24	5	12	24	5	12	24
Max. Coil Voltage		VDC	6.5	15	32	6.5	15	32	6.5	15	32	6.5	15	32
Coil Resistance	+/- 10%, 25° C	Ω	500	500	2150	200	500	2000	200	500	2000	200	500	2000
Operate Voltage	Must Operate by	VDC - Max.	3.8	9.6	19.2	3.8	9.6	19.2	3.8	9.6	19.2	3.8	9.6	19.2
Release Voltage	Must Release by	VDC - Min.	0.5	1.0	2.0	0.5	1.0	2.0	0.5	1.0	2.0	0.5	1.0	2.0
CONTACT RATINGS														
Switching Voltage	Max DC/Peak AC Resist.	Volts	200			200			100			100		
Switching Current	Max DC/Peak AC Resist.	Amps	0.5			0.5			0.25			0.25		
Carry Current	Max DC/Peak AC Resist.	Amps	1.0			1.0			0.5			0.5		
Contact Rating	Max DC/Peak AC Resist.	Watts	10			10			3			3		
Life Expectancy-Typical ¹	Signal Level 1.0V, 10mA	x 10 ⁶ Ops.	500			500			100			100		
Static Contact Resistance (max. init.)	50mV, 10mA	Ω	0.150			0.150			0.200			0.200		
Dynamic Contact Resistance (max. init.)	50mV, 50mA at 100 Hz, 1.5 msec	Ω	N/A			N/A			N/A			N/A		
RELAY SPECIFICATIONS														
Insulation Resistance (minimum)	Between all Isolated Pins at 100V, 25°C, 40% RH	Ω	10 ¹⁰			10 ¹⁰			10 ⁹			10 ⁹		
Capacitance - Typical Across Open Contacts	No Shield	pF	0.5			0.5			1.5			1.5		
	Shield Floating	pF	1.0			0.5			1.5			1.5		
	Shield Guarding	pF	0.5			0.2			1.0			1.0		
Open Contact to Coil	No Shield	pF	1.5			1.5			1.5			1.5		
	Shield Floating	pF	2.0			2.0			2.0			2.0		
	Shield Guarding	pF	0.5			0.5			0.5			0.5		
Contact to Shield	No Shield	pF	2.0			1.5			2.0			2.0		
	Shield Floating		2.0			1.5			2.0			2.0		
	Shield Guarding		2.0			1.5			2.0			2.0		
Dielectric Strength (minimum)	Between Contacts	VDC/peak AC	250			250			200			200		
	Contacts to Shield	VDC/peak AC	1500			1500			1500			1500		
	Contacts/Shield to Coil	VDC/peak AC	1500			1500			1500			1500		
Operate Time - including bounce - Typical	At Nominal Coil Voltage, 30 Hz Square Wave	msec.	0.5			0.5			1.0			1.0		
Release Time - Typical	No Suppression	msec.	0.5			0.5			1.0			1.0		

Top View:
Dot stamped on top of relay refers to pin #1 location
Grid = .1"x.1" (2.54mm x 2.54mm)

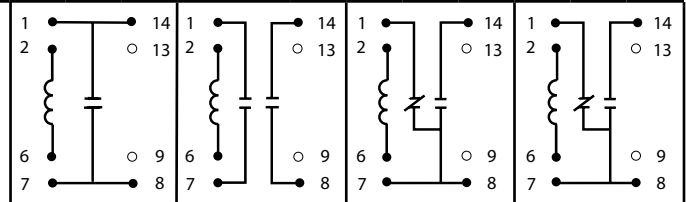

Notes:

- ¹ Consult factory for life expectancy at other switching loads.
- ² Molded depression on top of relay refers to pin #1 location.
- ³ Optional coil suppression diode across pins 2(+) and 6(-).
- ⁴ Optional ES Shield is tied to pin 9.
- ⁵ Surface mount processing temperature: 260°C max for 1 minute dwell time. Temperature measured on lead where lead exits molded package.

Environmental Ratings:

Storage Temp: -35°C to +100°C; *Operating Temp:* -20°C to +85°C;
Solder Temp: 270°C max; 10 sec. max
All electrical parameters measured at 25°C unless otherwise specified.
Vibration: 20 G's to 2000 Hz; *Shock:* 50 G's

06292019

Looking for pricing, stock, or lifecycle information?

Click below to explore more details on WIN SOURCE:

 [View 8L02-05-10 on WIN SOURCE](#)

 [Coto Technology](#) Information

Optimize Your Supply Chain with WIN SOURCE Solutions

-  Global Sourcing Solution
-  Obsolete Management
-  Cost Control Management
-  Shortage Management
-  Alternative Solution
-  Excess Inventory Management