



**THE DATASHEET OF  
BFC238566182**





## AC and Pulse Metallized Polypropylene Film Capacitors MKP Radial Potted Type

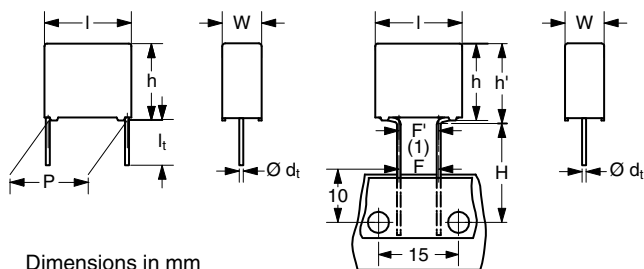

Dimensions in mm  
(1)  $|F - F'| < 0.3 \text{ mm}$   
 $F = 7.5 + 0.6/-0.1 \text{ mm}$

### FEATURES

7.5 mm bent back pitch, 10 mm and 15 mm lead pitch. Low contact resistance. Low loss dielectric. Small dimensions for high density packaging. Supplied loose in box and taped on reel.

RoHS compliant product.

### ENCAPSULATION

Flame retardant plastic case and epoxy resin  
UL-class 94 V-0

### CLIMATIC TESTING CLASS ACC. TO IEC 60068-1

55/110/56

### CAPACITANCE RANGE (E24 SERIES)

0.00047 to 0.033  $\mu\text{F}$

### CAPACITANCE TOLERANCE

$\pm 5 \%$

### LEADS

Tinned wire

### RATED (DC) TEMPERATURE

85 °C

### RATED (AC) TEMPERATURE

85 °C

### MAXIMUM APPLICATION TEMPERATURE

110 °C

### MAXIMUM OPERATING TEMPERATURE FOR LIMITED TIME

125 °C

### PERFORMANCE GRADE

Grade 1 (long life)

### STABILITY GRADE

Grade 2

### DETAIL SPECIFICATION

For more detailed data and test requirements contact:  
[dc-film@vishay.com](mailto:dc-film@vishay.com)

### APPLICATIONS

Where steep pulses occur e.g. SMPS (switch mode power supplies). Electronic lighting e.g. ballast. Motor control circuits.

### REFERENCE SPECIFICATIONS

IEC 60384-17

### MARKING

C-value; tolerance; rated voltage; code for dielectric material; manufacturer location; manufacturer's type; manufacturer's logo; year and week

### DIELECTRIC

Polypropylene film

### ELECTRODES

Metallized

### CONSTRUCTION

Internal serial construction

### RATED (DC) VOLTAGE

1600 V, 2000 V

### RATED (AC) VOLTAGE

550 V, 700 V

### RATED PEAK-TO-PEAK VOLTAGE

1600 V, 2000 V

# MKP 385



Vishay BCcomponents AC and Pulse Metallized Polypropylene Film Capacitors  
MKP Radial Potted Type

## COMPOSITION OF CATALOG NUMBER

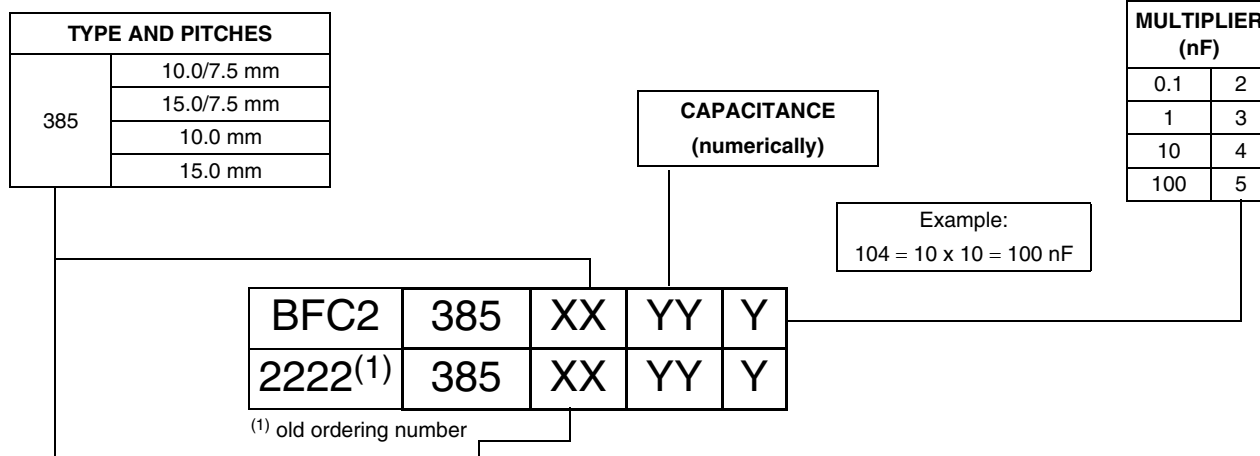

TYPE	PACKAGING	LEAD CONFIGURATION	PREFERRED TYPES				
			C-TOL.	1600 V		2000 V	
385	Loose in box	lead length 3.5 + 1/- 0.5 mm or 3.5 ± 0.3 mm	± 5 %	00	50	60	80
	Taped on reel <sup>(1)</sup>	H = 18.5 mm; P <sub>0</sub> = 12.7 mm reel diameter = 500 mm	± 5 %	02	52	62	82
	Taped on reel (bent back to 7.5 mm) <sup>(1)</sup>	H = 16.0 mm; P <sub>0</sub> = 15.0 mm reel diameter = 500 mm	± 5 %	03	53	63	83
	Ammopack <sup>(1)</sup>	H = 18.5 mm; P <sub>0</sub> = 12.7 mm	± 5 %	06	56	66	86
	Ammopack (bent back to 7.5 mm) <sup>(1)</sup>	H = 16.0 mm; P <sub>0</sub> = 15.0 mm	± 5 %	08	58	68	88
				<b>ON REQUEST</b>			
385	Loose in box	lead length 5.0 ± 1.0 mm	± 5 %	01	51	61	81
	Loose in box	lead length 25.0 ± 2.0 mm	± 5 %	04	54	64	84
	Taped on reel (bent back to 7.5 mm) <sup>(1)</sup>	H = 16.0 mm; P <sub>0</sub> = 15.0 mm reel diameter = 356 mm	± 5 %	05	55	65	85
	Loose in box	lead length 3.2 + 0.3/- 0.6 mm	± 5 %	07	57	67	87

**Note**

<sup>(1)</sup> For detailed tape specifications refer to "Packaging Information" [www.vishay.com/doc?28139](http://www.vishay.com/doc?28139) or end of catalog

## SPECIFIC REFERENCE DATA (1600 Vdc)

DESCRIPTION	VALUE	
	at 10 kHz	at 100 kHz
Tangent of loss angle:	≤ 5 x 10 <sup>-4</sup>	≤ 15 x 10 <sup>-4</sup>
Rated voltage pulse slope (dU/dt) <sub>R</sub> P = 10 mm and 10 mm bent back to 7.5 mm P = 15 mm and 15 mm bent back to 7.5 mm	> 4000 V/μs > 2000 V/μs	
R between leads, for C ≤ 1 μF at 500 V; 1 min	> 100 000 MΩ	
R between leads and case; 500 V; 1 min	> 30 000 MΩ	
Ionization (AC) voltage (typical value) at 20 pC peak discharge	> 600 V	
Withstanding (DC) voltage (cut off current 10 mA); rise time 100 V/s	2560 V; 1 min	
Withstanding (DC) voltage between leads and case	2840 V; 1 min	
Maximum application temperature	110 °C	



AC and Pulse Metallized Polypropylene Film Capacitors Vishay BCcomponents  
MKP Radial Potted Type

$U_{Rdc} = 1600\text{ V}$ ;  $U_{Rac} = 550\text{ V}$ ;  $U_{p-p} = 1600\text{ V}$ ;  $C\text{-tol.} = \pm 5\%$

C ( F)	Dimensions w x h (h') x l (mm)	Mass (g) <sup>(1)</sup>	CATALOG NUMBER BFC2 385 XXYYY AND PACKAGING							
			LOOSE IN BOX		REEL			AMMOPACK		C VALUE
			Leads 3.5 + 1/ - 0.5 mm <sup>(2)</sup>	Leads 25.0 ± 2.0 mm	Original Pitch	Pitch = 7.5 mm (bent back)		Original pitch	Pitch = 7.5 mm (bent back)	
						Ø 500 mm	Ø 365 mm			
XX (SPQ)	XX (SPQ)	XX (SPQ)	XX (SPQ)	XX (SPQ)	XX (SPQ)	XX (SPQ)	..YYY			
<b>Pitch = 10 ± 0.4 mm; d<sub>t</sub> = 0.60 ± 0.06 mm</b>					<b>Pitch = 10.0 mm</b>	<b>Pitch = 7.5 mm (bent back)</b>		<b>Pitch = 10.0 mm</b>	<b>Pitch = 7.5 mm (bent back)</b>	
0.002	4.0 x 10.0 (12.0) x 12.5	0.66								202
0.0022			50...	54...	52...	53...	-	56...	58...	222
0.0024			(1000)	(1250)	(1400)	(2000)		(950)	(1300)	242
0.0027										272
0.003										302
0.0033	5.0 x 11.0 (13.0) x 12.5	0.90								332
0.0036			50...	54...	52...	53...	-	56...	58...	362
0.0039			(1000)	(1250)	(1000)	(1900)		(750)	(1000)	392
0.0043										432
0.0047										472
0.0051	6.0 x 12.0 (14.0) x 12.5	1.1								512
0.0056			50...	54...	52...	53...	-	56...	58...	562
0.0062			(750)	(750)	(900)	(1500)		(600)	(850)	622
0.0068										682
<b>Pitch = 15 ± 0.4 mm; d<sub>t</sub> = 0.60 ± 0.06 mm</b>					<b>Pitch = 15.0 mm</b>	<b>Pitch = 7.5 mm (bent back)</b>				
0.0039	5.0 x 11.0 (13.0) x 17.5	1.1								392
0.0043										432
0.0047			00...	04...	02...	03...	05...			472
0.0051			(1250)	(1000)	(1100)	950	(550)			512
0.0056										562
0.0062										622
0.0068										682
0.0075			50...	54...	52...	53...	55...			752
0.0082			(1250)	(1000)	(1100)	(950)	(550)			822
0.0091			6.0 x 12.0 (14.0) x 17.5	1.4						
0.010	50...	54...			52...	53...	55...			103
0.011	(1000)	(1000)			(900)	(800)	(450)			113
0.012										123
<b>Pitch = 15 ± 0.4 mm; d<sub>t</sub> = 0.80 ± 0.08 mm</b>					<b>Pitch = 15.0 mm</b>	<b>Pitch = 7.5 mm (bent back)</b>				
0.013	7.0 x 13.5 (15.5) x 17.5	2.0								133
0.015			50...	54...	52...	53...	55...			153
0.016			(1000)	(500)	(800)	(700)	(400)			163
0.018	8.5 x 15.0 (17.0) x 17.5	2.5								183
0.020			50...	54...	52...	53...	55...			203
0.022			(1000)	(500)	(650)	(550)	(300)			223
0.024										243
0.027	10.0 x 16.5 (18.5) x 17.5	3.3								273
0.030			50...	54...	52...	53...	55...			303
0.033			(500)	(500)	(600)	(500)	(250)			333

**Notes**

<sup>(1)</sup> Net weight for short lead component

<sup>(2)</sup> l<sub>t</sub> = 3.5 ± 0.3 mm for pitch = 15 mm

• SPQ = Standard Packing Quantity

# MKP 385



Vishay BCcomponents AC and Pulse Metallized Polypropylene Film Capacitors  
MKP Radial Potted Type

## SPECIFIC REFERENCE DATA (2000 Vdc)

DESCRIPTION	VALUE	
	at 10 kHz	at 100 kHz
Tangent of loss angle:	$\leq 5 \times 10^{-4}$	$\leq 15 \times 10^{-4}$
Rated voltage pulse slope $(dU/dt)_R$ P = 10 mm and 10 mm bent back to 7.5 mm P = 15 mm and 15 mm bent back to 7.5 mm	$> 4000 \text{ V}/\mu\text{s}$ $> 2000 \text{ V}/\mu\text{s}$	
R between leads, for $C \leq 1 \mu\text{F}$ at 500 V; 1 min	$> 100\,000 \text{ M}\Omega$	
R between leads and case; 500 V; 1 min	$> 30\,000 \text{ M}\Omega$	
Ionization (AC) voltage (typical value) at 20 pC peak discharge	$> 750 \text{ V}$	
Withstanding (DC) voltage (cut off current 10 mA); rise time 100 V/s	3200 V; 1 min	
Withstanding (DC) voltage between leads and case	2840 V; 1 min	
Maximum application temperature	110 °C	

$U_{Rdc} = 2000 \text{ V}$ ;  $U_{Rac} = 700 \text{ V}$ ;  $U_{p-p} = 2000 \text{ V}$ ; C-tol. =  $\pm 5 \%$

C ( F)	Dimensions w x h (h') x l (mm)	Mass (g) <sup>(1)</sup>	CATALOG NUMBER BFC2 385 XXYYY AND PACKAGING							
			LOOSE IN BOX		REEL		AMMOPACK		C VALUE	
			Leads 3.5 + 1/ - 0.5 mm (2)	Leads 25.0 ± 2.0 mm	Original pitch	Pitch = 7.5 mm (bent back)		Original pitch		Pitch = 7.5 mm (bent back)
						Ø 500 mm	Ø 365 mm		XX (SPQ)	
			XX (SPQ)	XX (SPQ)	XX (SPQ)	XX (SPQ)	XX (SPQ)	XX (SPQ)	XX (SPQ)	..YYY
			Pitch = 10 ± 0.4 mm; d <sub>t</sub> = 0.60 ± 0.06 mm			Pitch = 10.0 mm	Pitch = 7.5 mm (bent back)	Pitch = 10.0 mm	Pitch = 7.5 mm	
0.00047	4.0 x 10.0 (12.0) x 12.5	0.66	60... (1000)	64... (1250)	62... (1400)	63... (2000)	-	66... (950)	68... (1300)	471
0.00051										511
0.00056										561
0.00062										621
0.00068										681
0.00075										751
0.00082										821
0.00091										911
0.001										102
0.0011										112
0.0012										122
0.0013										132
0.0015										152
0.0016	162									
0.0018	5.0 x 11.0 (13.0) x 12.5	0.90	60... (1000)	64... (1000)	62... (1100)	63... (1900)	-	66... (750)	68... (1000)	182
0.002										202
0.0022										222
0.0024										242
0.0027	6.0 x 12.0 (14.0) x 12.5	1.1	60... (750)	64... (750)	62... (900)	63... (1500)	-	66... (600)	68... (850)	272
0.003										302
0.0033										332
0.0036										362

### Notes

<sup>(1)</sup> Net weight for short lead component

<sup>(2)</sup> l<sub>t</sub> = 3.5 ± 0.3 mm for pitch = 15 mm

• SPQ = Standard Packing Quantity



AC and Pulse Metallized Polypropylene Film Capacitors Vishay BCcomponents  
MKP Radial Potted Type

C ( F)	Dimensions w x h (h') x l (mm)	Mass (g) <sup>(1)</sup>	CATALOG NUMBER BFC2 385 XXYYY AND PACKAGING																														
			LOOSE IN BOX		REEL			AMMOPACK		C VALUE																							
			Leads 3.5 + 1/ - 0.5 mm <sup>(2)</sup>	Leads 25.0 ± 2.0 mm	Original pitch	Pitch = 7.5 mm (bent back)		Original pitch	Pitch = 7.5 mm (bent back)																								
						Ø 500 mm	Ø 365 mm																										
XX (SPQ)	XX (SPQ)	XX (SPQ)	XX (SPQ)	XX (SPQ)	XX (SPQ)	XX (SPQ)	..YYY																										
<b>Pitch = 15 ± 0.4 mm; d<sub>t</sub> = 0.60 ± 0.06 mm</b>					<b>Pitch = 15.0</b>	<b>Pitch = 7.5 mm (bent back)</b>																											
0.00047 0.00051 0.00056 0.00062 0.00068 0.00075 0.00082 0.00091 0.0010 0.0011 0.0012 0.0013 0.0015 0.0016 0.0018	5.0 x 11.0 (13.0) x 17.5	1.1	80... (1250)	84... (1000)	82... (1100)	83... (950)	85... (550)	-	471 511 561 621 681 751 821 911 102 112 122 132 152 162 182																								
<b>Pitch = 15 ± 0.4 mm; d<sub>t</sub> = 0.60 ± 0.06 mm</b>											<b>Pitch = 15.0</b>	<b>Pitch = 7.5 mm (bent back)</b>																					
0.0020 0.0022 0.0024 0.0027 0.0030 0.0033 0.0036									5.0 x 11.0 (13.0) x 17.5	1.1	80... (1250)	84... (1000)	82... (1100)	83... (950)	85... (550)	-	202 222 242 272 302 332 362																
0.0039 0.0043 0.0047																	6.0 x 12.0 (14.0) x 17.5	1.4	60... (1250)	64... (1000)	62... (1100)	63... (950)	65... (550)	-	392 432 472								
0.0051 0.0056 0.0062 0.0068																									6.0 x 12.0 (14.0) x 17.5	1.4	60... (1000)	64... (1000)	62... (900)	63... (800)	65... (450)	-	512 562 622 682
<b>Pitch = 15 ± 0.4 mm; d<sub>t</sub> = 0.80 ± 0.08 mm</b>																																	
0.0075 0.0082 0.0091 0.010																	7.0 x 13.5 (15.5) x 17.5	2	60... (1000)	64... (500)	62... (800)	63... (700)	65... (400)	-									752 822 912 103
0.011 0.012 0.013																									8.5 x 15.0 (17.0) x 17.5	2.5	60... (1000)	64... (500)	62... (650)	63... (550)	65... (300)	-	113 123 133
0.015 0.016 0.018 0.020									10.0 x 16.5 (18.5) x 17.5	3.3	60... (500)	64... (500)	62... (600)	63... (500)	65... (250)	-																	153 163 183 203

**Notes**

- <sup>(1)</sup> Net weight for short lead component
- <sup>(2)</sup> l<sub>t</sub> = 3.5 ± 0.3 mm for pitch = 15 mm
- SPQ = Standard Packing Quantity

## MKP 385



### Vishay BCcomponents AC and Pulse Metallized Polypropylene Film Capacitors MKP Radial Potted Type

#### MOUNTING

##### Normal use

The capacitors are designed for mounting on printed-circuit boards. The capacitors packed in bandoliers are designed for mounting on printed-circuit boards by means of automatic insertion machines.

For detailed tape specifications refer to “Packaging Information” [www.vishay.com/doc?28139](http://www.vishay.com/doc?28139) or end of catalog

##### Specific Method of Mounting to Withstand Vibration and Shock

In order to withstand vibration and shock tests, it must be ensured that the stand-off pips are in good contact with the printed-circuit board. The capacitors shall be mechanically fixed by the leads.

##### Space Requirements on Printed-Circuit Board

The maximum length and width of film capacitors is shown in the drawing:

- Eccentricity as in drawing. The maximum eccentricity is smaller than or equal to the lead diameter of the product concerned.
- Product height with seating plane as given by “IEC 60717” as reference:  $h_{max.} \leq h + 0.3 \text{ mm}$ .

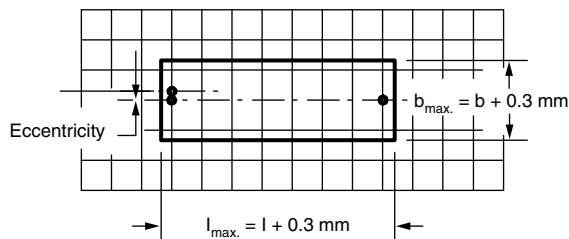

##### Storage Temperature

- Storage temperature:  $T_{stg} = -25 \text{ }^{\circ}\text{C}$  to  $+40 \text{ }^{\circ}\text{C}$  with RH maximum 80 % without condensation

##### Ratings and Characteristics Reference Conditions

Unless otherwise specified, all electrical values apply to an ambient free temperature of  $23 \text{ }^{\circ}\text{C} \pm 1 \text{ }^{\circ}\text{C}$ , an atmospheric pressure of 86 kPa to 106 kPa and a relative humidity of  $50 \% \pm 2 \%$ .

For reference testing, a conditioning period shall be applied over  $96 \text{ h} \pm 4 \text{ h}$  by heating the products in a circulating air oven at the rated temperature and a relative humidity not exceeding 20 %.



AC and Pulse Metallized Polypropylene Film Capacitors Vishay BCcomponents  
MKP Radial Potted Type

**CHARACTERISTICS**

Capacitance as a function of ambient temperature (typical curve) (1 kHz)

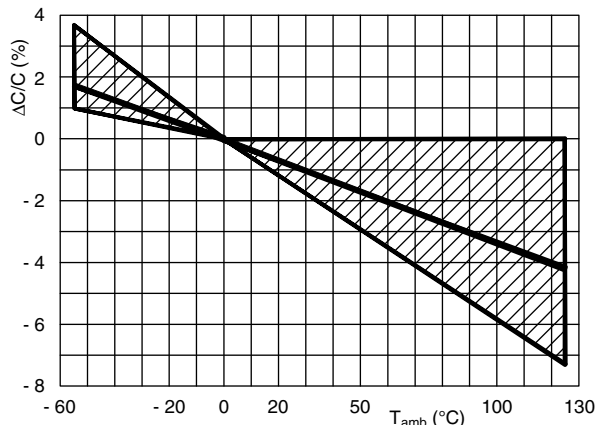

Impedance as a function of frequency (typical curve)

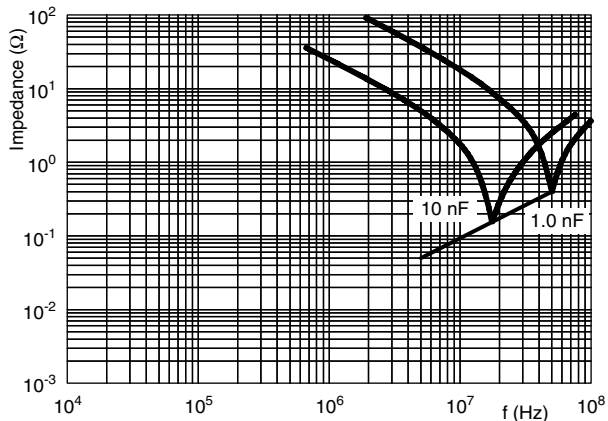

Max. DC and AC voltage as a function of temperature

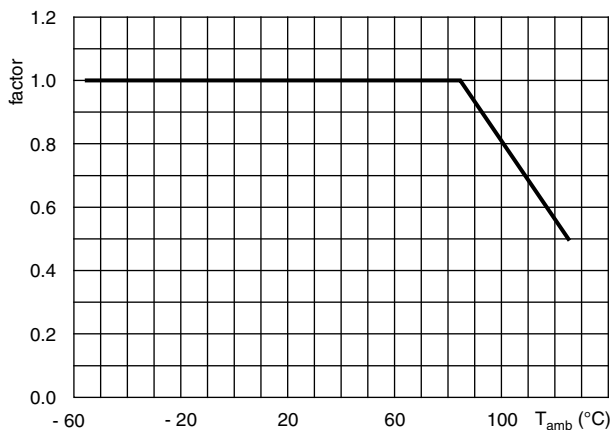

Max. RMS voltage as a function of frequency

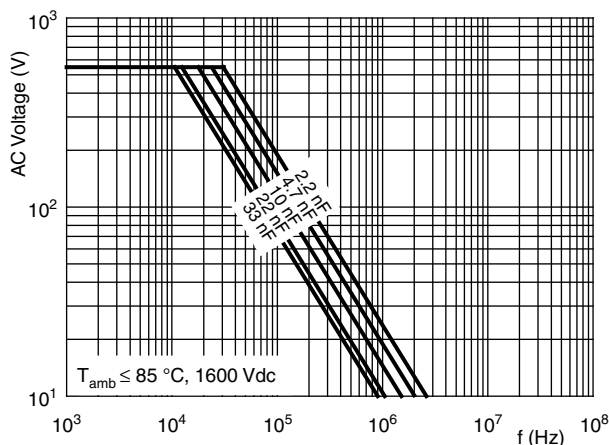

Max. RMS voltage as a function of frequency

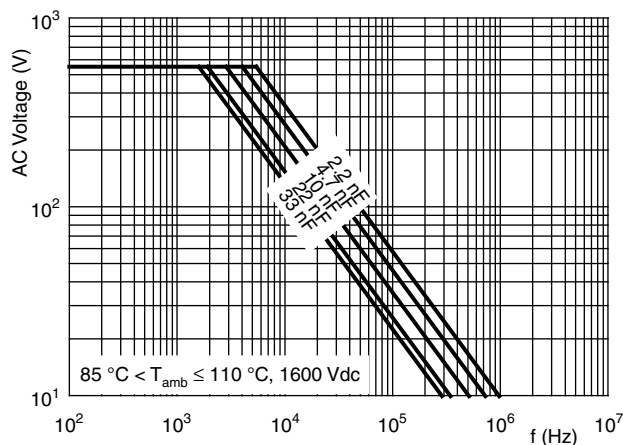

# MKP 385

Vishay BCcomponents AC and Pulse Metallized Polypropylene Film Capacitors  
MKP Radial Potted Type



Max. RMS voltage as a function of frequency

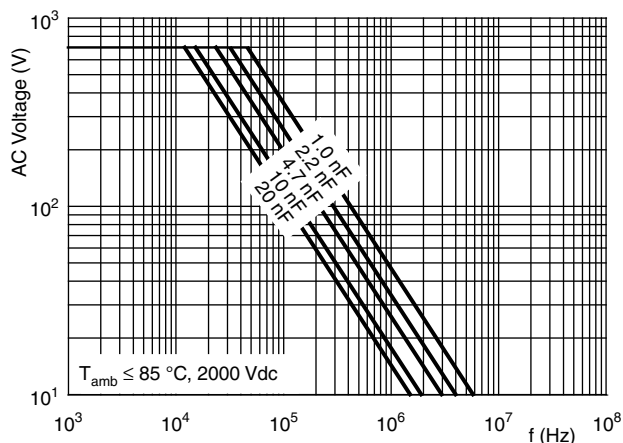

Max. RMS voltage as a function of frequency

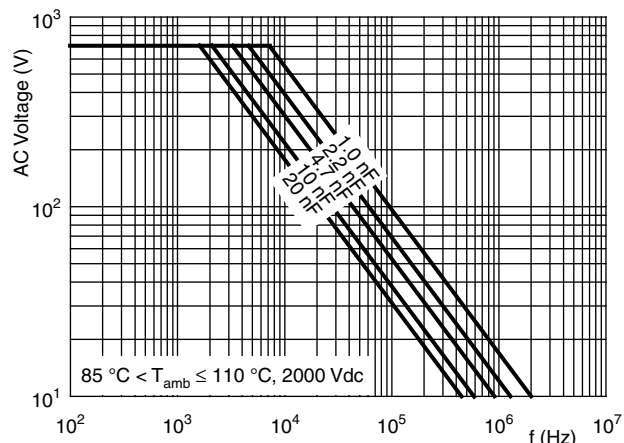

Insulation resistance as a function of ambient temperature (typical curve)

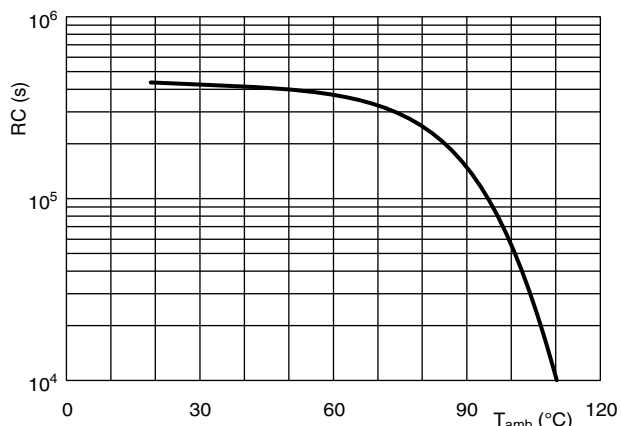

Maximum allowed component temperature rise ( $\Delta T$ ) as a function of ambient temperature ( $T_{amb}$ )

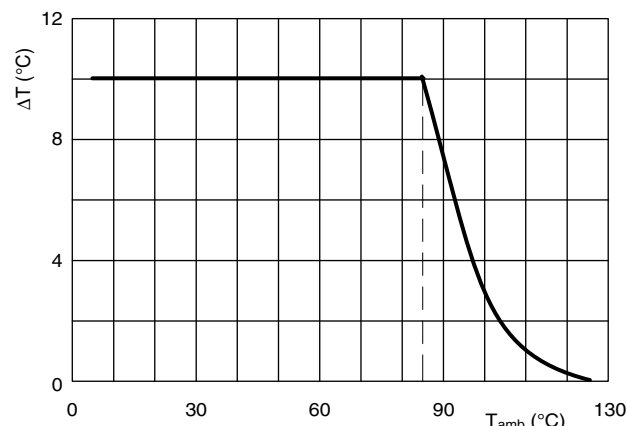

Tangent of loss angle as a function of frequency (typical curve)

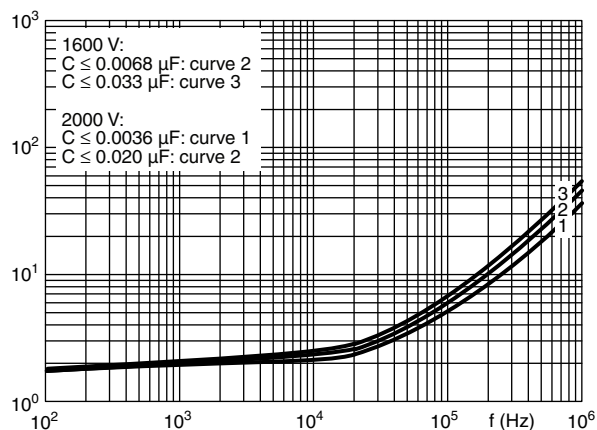



AC and Pulse Metallized Polypropylene Film Capacitors Vishay BCcomponents  
MKP Radial Potted Type

**HEAT CONDUCTIVITY (G) AS A FUNCTION OF ORIGINAL PITCH AND CAPACITOR BODY THICKNESS IN mW/°C**

W <sub>max.</sub> (mm)	HEAT CONDUCTIVITY (mW/°C)	
	PITCH 10 mm	PITCH 15 mm
4.0	6.5	-
5.0	7.5	10
6.0	9.0	11
7.0	-	12
8.5	-	16
10.0	-	18

**POWER DISSIPATION AND MAXIMUM COMPONENT TEMPERATURE RISE**

The power dissipation must be limited in order not to exceed the maximum allowed component temperature rise as a function of the free air ambient temperature.

The power dissipation can be calculated according type detail specification “HQN-384-01/101: Technical Information Film Capacitors” with the typical tgδ of the curves.

The component temperature rise (ΔT) can be measured (see section “Measuring the Component Temperature” for more details) or calculated by  $\Delta T = P/G$ :

- ΔT = Component temperature rise (°C)
- P = Power dissipation of the component (mW)
- G = Heat conductivity of the component (mW/°C)

**MEASURING THE COMPONENT TEMPERATURE**

A thermocouple must be attached to the capacitor body as in:

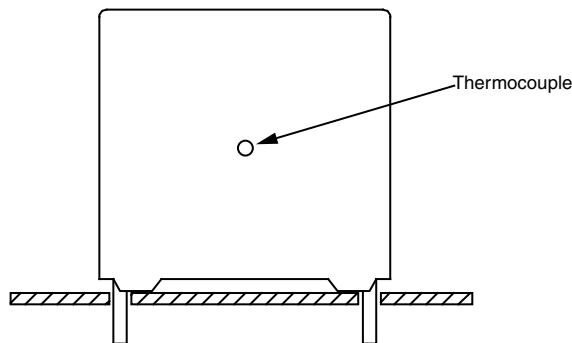

The temperature is measured in unloaded ( $T_{amb}$ ) and maximum loaded condition ( $T_c$ ).

The temperature rise is given by  $\Delta T = T_c - T_{amb}$ .

To avoid radiation or convection, the capacitor should be tested in a wind-free box.

# MKP 385



## Vishay BCcomponents AC and Pulse Metallized Polypropylene Film Capacitors MKP Radial Potted Type

### APPLICATION NOTE AND LIMITING CONDITIONS

These capacitors are not suitable for mains applications as across-the-line capacitors without additional protection, as described hereunder. These mains applications are strictly regulated in safety standards and therefore electromagnetic interference suppression capacitors conforming the standards must be used.

To select the capacitor for a certain application, the following conditions must be checked:

1. The peak voltage ( $U_p$ ) shall not be greater than the rated DC voltage ( $U_{Rdc}$ )
2. The peak-to-peak voltage ( $U_{p-p}$ ) shall not be greater than the maximum ( $U_{p-p}$ ) to avoid the ionisation inception level
3. The voltage peak slope ( $dU/dt$ ) shall not exceed the rated voltage pulse slope in an RC-circuit at rated voltage and without ringing. If the pulse voltage is lower than the rated DC voltage, the rated voltage pulse slope may be multiplied by  $U_{Rdc}$  and divided by the applied voltage.

For all other pulses following equation must be fulfilled:

$$2 \times \int_0^T \left( \frac{dU}{dt} \right)^2 \times dt < U_{Rdc} \times \left( \frac{dU}{dt} \right)_{rated}$$

T is the pulse duration

4. The maximum component surface temperature rise must be lower than the limits (see figure max allowed component temp rise)
5. Since in circuits used at voltages over 280 V peak-to-peak the risk for an intrinsically active flammability after a capacitor breakdown (short circuit) increases, it is recommended that the power to the component is limited to 100 times the values mentioned in the table: "Heat conductivity"
6. When using these capacitors as across-the-line capacitor in the input filter for mains applications or as series connected with an impedance to the mains the applicant must guarantee that the following conditions are fulfilled in any case (spikes and surge voltages from the mains included).

### Voltage Conditions for 6 Above

ALLOWED VOLTAGES	$T_{amb} \leq 85 \text{ }^\circ\text{C}$	$85 \text{ }^\circ\text{C} < T_{amb} \leq 110 \text{ }^\circ\text{C}$	$110 \text{ }^\circ\text{C} < T_{amb} \leq 125 \text{ }^\circ\text{C}$
Maximum continuous RMS voltage	$U_{Rac}$	$0.7 \times U_{Rac}$	$0.5 \times U_{Rac}$
Maximum temporary RMS-overvoltage (< 24 h)	$1.25 \times U_{Rac}$	$0.875 \times U_{Rac}$	$0.625 \times U_{Rac}$
Maximum peak voltage ( $V_{o-p}$ ) (< 2 s)	$1.6 \times U_{Rdc}$	$1.1 \times U_{Rdc}$	$0.8 \times U_{Rdc}$

### EXAMPLE

C = 4n7 1600 V used for the voltage signal shown in next figure.

$U_{p-p} = 1000 \text{ V}$ ;  $U_p = 900 \text{ V}$ ;  $T_1 = 12 \text{ } \mu\text{s}$ ;  $T_2 = 64 \text{ } \mu\text{s}$ ;  $T_3 = 4 \text{ } \mu\text{s}$

The ambient temperature is 80 °C. In case of failure, the oscillation is blocked.

Checking the conditions:

1. The peak voltage  $U_p = 900 \text{ V}$  is lower than 1600 Vdc
2. The peak-to-peak voltage 1000 V is lower than  $2 \sqrt{2} \times 550 \text{ Vac} = 1600 U_{p-p}$
3. The voltage pulse slope  $dU/dt = 1000 \text{ V} / 4 \text{ } \mu\text{s} = 250 \text{ V}/\mu\text{s}$ . This is lower than 4000 V/ $\mu\text{s}$  (see specific reference data for each version)
4. The dissipated power is 35 mW as calculated with Fourier terms and typical tg $\delta$ .  
The temperature rise for  $w_{max} = 6.0$  and pitch = 10 mm will be  $35 \text{ mW} / 9 \text{ mW}/^\circ\text{C} = 3.9 \text{ }^\circ\text{C}$   
This is lower than 10 °C temperature rise at 80 °C, acc. figure.
5. Oscillation is blocked
6. Not applicable

Voltage signal:

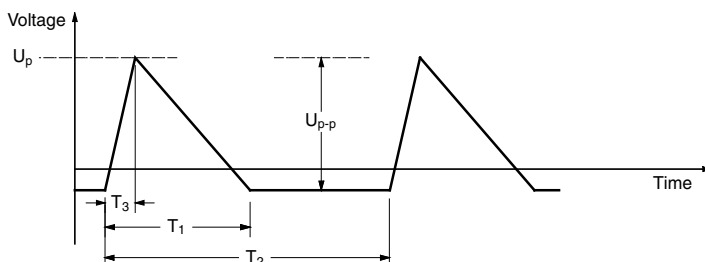



AC and Pulse Metallized Polypropylene Film Capacitors Vishay BCcomponents  
MKP Radial Potted Type

**INSPECTION REQUIREMENTS**

**General Notes:**

Sub-clause numbers of tests and performance requirements refer to the “Sectional Specification, Publication IEC 60384-17 and Specific Reference Data”.

**Group C Inspection Requirements**

SUB-CLAUSE NUMBER AND TEST	CONDITIONS	PERFORMANCE REQUIREMENTS
<b>SUB-GROUP C1A PART OF SAMPLE OF SUB-GROUP C1</b>		
4.1 Dimensions (detail)		As specified in chapters “General Data” of this specification
4.3.1 Initial measurements	Capacitance Tangent of loss angle at 100 kHz	
4.3 Robustness of terminations	Tensile: Load 10 N; 10 s Bending: Load 5 N; 4 x 90°	No visible damage
4.4 Resistance to soldering heat	Method: 1A Solder bath: 280 °C ± 5 °C Duration: 10 s	
4.14 Component solvent resistance	Isopropylalcohol at room temperature Method: 2 Immersion time: 5 ± 0.5 min Recovery time: Min. 1 h, max. 2 h	
4.4.2 Final measurements	Visual examination  Capacitance  Tangent of loss angle	No visible damage Legible marking  $ \Delta C/C  \leq 1\% + 5 \text{ pF}$ of the value measured initially  Increase of $\tan \delta: \leq 0.0005$ Compared to values measured in 4.3.1
<b>SUB-GROUP C1B PART OF SAMPLE OF SUB-GROUP C1</b>		
4.6.1 Initial measurements	Capacitance Tangent of loss angle at 100 kHz	
4.15 Solvent resistance of the marking	Isopropylalcohol at room temperature Method: 1 Rubbing material: cotton wool Immersion time: 5 ± 0.5 min	No visible damage Legible marking
4.6 Rapid change of temperature	$\theta A = - 55 \text{ }^\circ\text{C}$ $\theta B = + 105 \text{ }^\circ\text{C}$ 5 cycles Duration $t = 30 \text{ min}$	
4.6.1 Inspection	Visual examination	
4.7 Vibration	Mounting: See section “Mounting” of this specification Procedure B4 Frequency range: 10 Hz to 55 Hz Amplitude: 0.75 mm or Acceleration 98 m/s <sup>2</sup> (whichever is less severe) Total duration 6 h	No visible damage

# MKP 385



## Vishay BCcomponents AC and Pulse Metallized Polypropylene Film Capacitors MKP Radial Potted Type

SUB-CLAUSE NUMBER AND TEST	CONDITIONS	PERFORMANCE REQUIREMENTS
4.7.2 Final inspection 4.9 Shock 4.9.3 Final measurements	Visual examination Mounting: See section "Mounting" of this specification Pulse shape: Half sine Acceleration: 490 m/s <sup>2</sup> Duration of pulse: 11 ms Visual examination  Capacitance  Tangent of loss angle  Insulation resistance	No visible damage  No visible damage  For C $ \Delta C/C  \leq 2\%$ or of the value measured in 4.6.1. Increase of $\tan \delta: \leq 0.0005$ Compared to values measured in 4.6.1 As specified in section "Insulating Resistance" of this specification
<b>SUB-GROUP C1 COMBINED SAMPLE OF SPECIMENS OF SUB-GROUPS C1A AND C1B</b>		
4.10 Climatic sequence 4.10.2 Dry heat 4.10.3 Damp heat cyclic Test Db, first cycle 4.10.4 Cold 4.10.6 Damp heat cyclic Test Db, remaining cycles 4.10.6.2 Final measurements	Temperature: + 105 °C Duration: 16 h  Temperature: - 55 °C Duration: 2 h  Voltage proof = $U_{Rdc}$ for 1 min within 15 min after removal from testchamber Visual examination  Capacitance  Tangent of loss angle  Insulation resistance	No breakdown of flash-over  No visible damage Legible marking $ \Delta C/C  \leq 2\%$ of the value measured in 4.4.2 or 4.9.3 Increase of $\tan \delta: \leq 0.005$ Compared to values measured in 4.3.1 or 4.6.1 $\geq 50\%$ of values specified in section "Insulation Resistance" of this specification
<b>SUB-GROUP C2</b>		
4.11 Damp heat steady state 4.11.1 Initial measurements 4.11.3 Final measurements	56 days, 40 °C, 90 % to 95 % RH no load Capacitance Tangent of loss angle at 1 kHz Voltage proof = $U_{Rdc}$ for 1 min within 15 min after removal from testchamber Visual examination  Capacitance  Tangent of loss angle  Insulation resistance	No breakdown of flash-over  No visible damage Legible marking $ \Delta C/C  \leq 1\% + 5\text{ pF}$ of the value measured in 4.11.1. Increase of $\tan \delta \leq 0.0005$ Compared to values measured in 4.11.1 $\geq 50\%$ of values specified in section "Insulation Resistance" of this specification



AC and Pulse Metallized Polypropylene Film Capacitors Vishay BCcomponents  
MKP Radial Potted Type

SUB-CLAUSE NUMBER AND TEST	CONDITIONS	PERFORMANCE REQUIREMENTS
<b>SUB GROUP C3A</b>		
4.12.1 Endurance	Duration: 2000 h Temperature: 85 °C Voltage: 1.25 x U <sub>Rac</sub> V <sub>rms</sub> , 50 Hz Duration: 2000 h Temperature: 105 °C	
4.12.1.1 Initial measurements	Voltage: 0.875 x U <sub>Rac</sub> V <sub>rms</sub> , 50 Hz Capacitance Tangent of loss angle at 100 kHz	
4.12.1.3 Final measurements	Visual examination  Capacitance  Tangent of loss angle  Insulation resistance	No visible damage Legible marking Temperature: 85 °C  $ \Delta C/C  \leq 5\%$ for C > 10 nF $ \Delta C/C  \leq 8\%$ for C ≤ 10 nF compared to values measured in 4.12.1.1  Increase of tan δ: ≤ 0.005 Compared to values measured in 4.12.1.1  ≥ 50 % of values specified in section "Insulation Resistance" of this specification
<b>SUB GROUP C3B</b>		
4.12.2 Endurance test at 50 Hz alternating voltage	Duration: 500 h Voltage:	
4.12.2.1 Initial measurements	0.625 x U <sub>Rac</sub> at 125 °C Capacitance Tangent of loss angle:	
4.12.2.3 Final measurements	Visual examination  Capacitance  Tangent of loss angle  Insulation resistance	No visible damage Legible marking  $ \Delta C/C  \leq 10\%$ for C + 100 pF compared values measured in 4.42.2.1  Increase of tan δ: ≤ 0.0005 Compared to values measured in 4.12.2.1  ≥ 50 % of values specified in section "Insulation Resistance" of this specification
<b>SUB-GROUP C4</b>		
4.2.6 Temperature characteristics Initial measurements Intermediate measurements	Capacitance Capacitance at - 55 °C Capacitance at - 20 °C Capacitance at + 125 °C	For - 55 °C to + 20 °C: + 1 % ≤ $ \Delta C/C $ ≤ 3.75 % or for 20 °C to 125 °C - 7.5 % ≤ $ \Delta C/C $ ≤ 0 % compared to values measured in 4.12.1.1
Final measurement	Capacitance  Insulation resistance	As specified in section "Capacitance" of this specification As specified in chapters "Insulation Resistance" of this specification

# MKP 385



## Vishay BCcomponents AC and Pulse Metallized Polypropylene Film Capacitors MKP Radial Potted Type

SUB-CLAUSE NUMBER AND TEST	CONDITIONS	PERFORMANCE REQUIREMENTS
<b>SUB-GROUP C4</b>		
4.13 Charge and discharge	10 000 cycles Charged to $U_R$ Vdc Discharge resistance:	
	$R = \frac{U_R}{C \times 2.5 \times (dU/dt)_R}$	
4.13.1 Initial measurements	Capacitance Tangent of loss angle: at 100 kHz or	
4.13.3 Final measurements	Capacitance  Tangent of loss angle  Insulation resistance	$ \Delta C/C  \leq 1\%$ compared to values measured in 4.13.1  Increase of $\tan \delta$ : $\leq 0.0005$ Compared to values measured in 4.13.1  $\geq 50\%$ of values specified in section "Insulation Resistance" of this specification
<b>SUB-GROUP ADD 1</b>		
A.1 Ignition of lamp test		
A.1.1 Initial measurements	Capacitance Tangent of loss angle at 100 kHz	
A.1.2 Ignition of lamp test	Temperature: 85 °C 1000 cycles: 1 s ON 29 s OFF Frequency: 60 kHz Voltage: 1600 V type: 2800 $V_{pp}$ 2000 V type: 3000 $V_{pp}$	
A.1.2 Final measurements	Visual examination Capacitance  Tangent of loss angle at 100 kHz  Insulation resistance	No visible damage $ \Delta C/C  \leq 5\%$ of the value measured in  A.1.1 Increase of $\tan \delta$ : $\leq 0.0005$ Compared to values measured in A.1.1  $\geq 50\%$ of values specified in section "Insulation Resistance" of this specification



## Disclaimer

ALL PRODUCT, PRODUCT SPECIFICATIONS AND DATA ARE SUBJECT TO CHANGE WITHOUT NOTICE TO IMPROVE RELIABILITY, FUNCTION OR DESIGN OR OTHERWISE.

Vishay Intertechnology, Inc., its affiliates, agents, and employees, and all persons acting on its or their behalf (collectively, "Vishay"), disclaim any and all liability for any errors, inaccuracies or incompleteness contained in any datasheet or in any other disclosure relating to any product.

Vishay makes no warranty, representation or guarantee regarding the suitability of the products for any particular purpose or the continuing production of any product. To the maximum extent permitted by applicable law, Vishay disclaims (i) any and all liability arising out of the application or use of any product, (ii) any and all liability, including without limitation special, consequential or incidental damages, and (iii) any and all implied warranties, including warranties of fitness for particular purpose, non-infringement and merchantability.

Statements regarding the suitability of products for certain types of applications are based on Vishay's knowledge of typical requirements that are often placed on Vishay products in generic applications. Such statements are not binding statements about the suitability of products for a particular application. It is the customer's responsibility to validate that a particular product with the properties described in the product specification is suitable for use in a particular application. Parameters provided in datasheets and/or specifications may vary in different applications and performance may vary over time. All operating parameters, including typical parameters, must be validated for each customer application by the customer's technical experts. Product specifications do not expand or otherwise modify Vishay's terms and conditions of purchase, including but not limited to the warranty expressed therein.

Except as expressly indicated in writing, Vishay products are not designed for use in medical, life-saving, or life-sustaining applications or for any other application in which the failure of the Vishay product could result in personal injury or death. Customers using or selling Vishay products not expressly indicated for use in such applications do so at their own risk. Please contact authorized Vishay personnel to obtain written terms and conditions regarding products designed for such applications.

No license, express or implied, by estoppel or otherwise, to any intellectual property rights is granted by this document or by any conduct of Vishay. Product names and markings noted herein may be trademarks of their respective owners.

## Material Category Policy

**Vishay Intertechnology, Inc. hereby certifies that all its products that are identified as RoHS-Compliant fulfill the definitions and restrictions defined under Directive 2011/65/EU of The European Parliament and of the Council of June 8, 2011 on the restriction of the use of certain hazardous substances in electrical and electronic equipment (EEE) - recast, unless otherwise specified as non-compliant.**

**Please note that some Vishay documentation may still make reference to RoHS Directive 2002/95/EC. We confirm that all the products identified as being compliant to Directive 2002/95/EC conform to Directive 2011/65/EU.**

**Vishay Intertechnology, Inc. hereby certifies that all its products that are identified as Halogen-Free follow Halogen-Free requirements as per JEDEC JS709A standards. Please note that some Vishay documentation may still make reference to the IEC 61249-2-21 definition. We confirm that all the products identified as being compliant to IEC 61249-2-21 conform to JEDEC JS709A standards.**

## Looking for pricing, stock, or lifecycle information?

Click below to explore more details on WIN SOURCE:

 [View BFC238566182 on WIN SOURCE](#)

 [Vishay Information](#)

## Optimize Your Supply Chain with WIN SOURCE Solutions

-  Global Sourcing Solution
-  Obsolete Management
-  Cost Control Management
-  Shortage Management
-  Alternative Solution
-  Excess Inventory Management