



**THE DATASHEET OF  
BAS7002WH6327XTSA1**



**Silicon Schottky Diode**

- General-purpose diode for high-speed switching
- Circuit protection
- Voltage clamping
- High-level detecting and mixing
- BAS70-04S: For orientation in reel see package information below
- Pb-free (RoHS compliant) package
- Qualified according AEC Q101<sup>1)</sup>

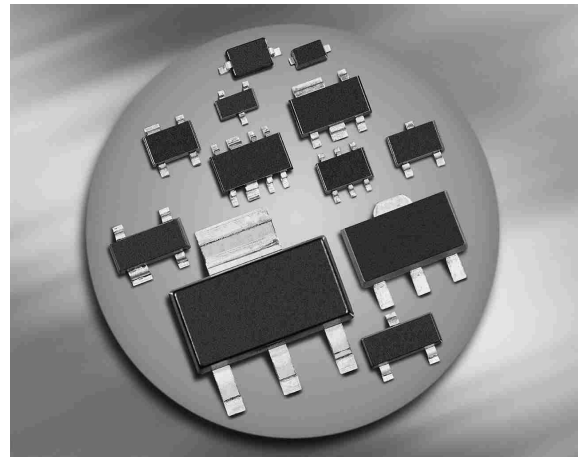

**BAS170W**  
**BAS70-02L**  
**BAS70-02W**  
**BAS70-02V**



**BAS70**

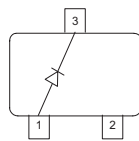

**BAS70-04**  
**BAS70-04W**

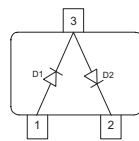

**BAS70-04S**

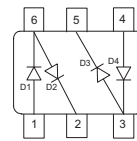

**BAS70-05**  
**BAS70-05W**

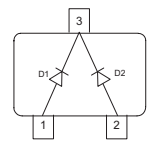

**BAS70-06**  
**BAS70-06W**

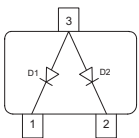

**BAS70-07**  
**BAS70-07W**

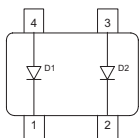

<sup>1)</sup>BAS70-02L is not qualified according AEC Q101

| Type       | Package  | Configuration    | $L_S$ (nH) | Marking |
|------------|----------|------------------|------------|---------|
| BAS170W    | SOD323   | single           | 1.8        | white 7 |
| BAS70      | SOT23    | single           | 1.8        | 73s     |
| BAS70-02L  | TSLP-2-1 | single, leadless | 0.4        | F       |
| BAS70-02V  | SC79     | single           | 0.6        | c       |
| BAS70-02W* | SCD80    | single           | 0.6        | 73      |
| BAS70-04   | SOT23    | series           | 1.8        | 74s     |
| BAS70-04S  | SOT363   | dual series      | 1.6        | 74s     |
| BAS70-04W  | SOT323   | series           | 1.4        | 74s     |
| BAS70-05   | SOT23    | common cathode   | 1.8        | 75s     |
| BAS70-05W  | SOT323   | common cathode   | 1.4        | 75s     |
| BAS70-06   | SOT23    | common anode     | 1.8        | 76s     |
| BAS70-06W  | SOT323   | common anode     | 1.4        | 76s     |
| BAS70-07   | SOT143   | parallel pair    | 2          | 77s     |
| BAS70-07W  | SOT343   | parallel pair    | 1.8        | 77s     |

\* Not for new design

**Maximum Ratings** at  $T_A = 25\text{ °C}$ , unless otherwise specified

| Parameter   | Symbol    | Value       | Unit |
|---|-----------|-------------|------|
| Diode reverse voltage   | $V_R$     | 70          | V    |
| Forward current   | $I_F$     | 70          | mA   |
| Non-repetitive peak surge forward current<br>$t \leq 10\text{ms}$ | $I_{FSM}$ | 100         |      |
| Total power dissipation   | $P_{tot}$ |             | mW   |
| BAS70, BAS70-07, $T_S \leq 72\text{ °C}$                          |           | 250         |      |
| BAS70-02L, $T_S \leq 117\text{ °C}$                               |           | 250         |      |
| BAS70-02W, -02V, $T_S \leq 107\text{ °C}$                         |           | 250         |      |
| BAS70-04, BAS70-06, $T_S \leq 48\text{ °C}$                       |           | 250         |      |
| BAS70-04S/W/-06W, BAS170W, $T_S \leq 97\text{ °C}$                |           | 250         |      |
| BAS70-05, $T_S \leq 22\text{ °C}$                                 |           | 250         |      |
| BAS70-05W, $T_S \leq 90\text{ °C}$                                |           | 250         |      |
| BAS70-07W, $T_S \leq 114\text{ °C}$                               |           | 250         |      |
| Junction temperature  | $T_J$     | 150         | °C   |
| Operating temperature range                                       | $T_{op}$  | -55 ... 125 |      |
| Storage temperature   | $T_{Stg}$ | -55 ... 150 |      |

**Thermal Resistance**

| Parameter                                | Symbol     | Value | Unit |
|--|------------|-------|------|
| Junction - soldering point <sup>1)</sup> | $R_{thJS}$ |       | K/W  |
| BAS70, BAS70-07                          |            | ≤ 310 |      |
| BAS70-02L                                |            | ≤ 130 |      |
| BAS70-02W, -02V                          |            | ≤ 170 |      |
| BAS70-04, BAS70-06                       |            | ≤ 410 |      |
| BAS70-04S/W, BAS70-06W                   |            | ≤ 210 |      |
| BAS70-05                                 |            | ≤ 510 |      |
| BAS70-05W                                |            | ≤ 240 |      |
| BAS70-07W                                |            | ≤ 145 |      |
| BAS170W                                  |            | ≤ 190 |      |

**Electrical Characteristics at  $T_A = 25\text{ °C}$ , unless otherwise specified**

| Parameter | Symbol | Values |      |      | Unit |
|-----------|--------|--------|------|------|------|
|           |        | min.   | typ. | max. |      |

**DC Characteristics**

|  |              |                   |                   |                    |               |
|--|--------------|-------------------|-------------------|--------------------|---------------|
| Breakdown voltage<br>$I_{(BR)} = 10\text{ }\mu\text{A}$                                | $V_{(BR)}$   | 70                | -                 | -                  | V             |
| Reverse current<br>$V_R = 50\text{ V}$   | $I_R$        | -                 | -                 | 0.1                | $\mu\text{A}$ |
| Forward voltage<br>$I_F = 1\text{ mA}$<br>$I_F = 10\text{ mA}$<br>$I_F = 15\text{ mA}$ | $V_F$        | 300<br>600<br>720 | 375<br>705<br>880 | 410<br>750<br>1000 | mV            |
| Forward voltage matching <sup>2)</sup><br>$I_F = 10\text{ mA}$                         | $\Delta V_F$ | -                 | -                 | 20                 |               |

<sup>1</sup>For calculation of  $R_{thJA}$  please refer to Application Note AN077 (Thermal Resistance Calculation)

<sup>2</sup> $\Delta V_F$  is the difference between lowest and highest  $V_F$  in a multiple diode component.

**Electrical Characteristics** at  $T_A = 25\text{ °C}$ , unless otherwise specified

| Parameter   | Symbol      | Values |      |      | Unit     |
|---|-------------|--------|------|------|----------|
|   |             | min.   | typ. | max. |          |
| <b>AC Characteristics</b>                                     |             |        |      |      |          |
| Diode capacitance<br>$V_R = 0, f = 1\text{ MHz}$              | $C_T$       | -      | 1.5  | 2    | pF       |
| Forward resistance<br>$I_F = 10\text{ mA}, f = 10\text{ kHz}$ | $r_f$       | -      | 34   | -    | $\Omega$ |
| Charge carrier life time<br>$I_F = 25\text{ mA}$              | $\tau_{rr}$ | -      | -    | 100  | ps       |

**Diode capacitance  $C_T = f(V_R)$**

$f = 1\text{MHz}$

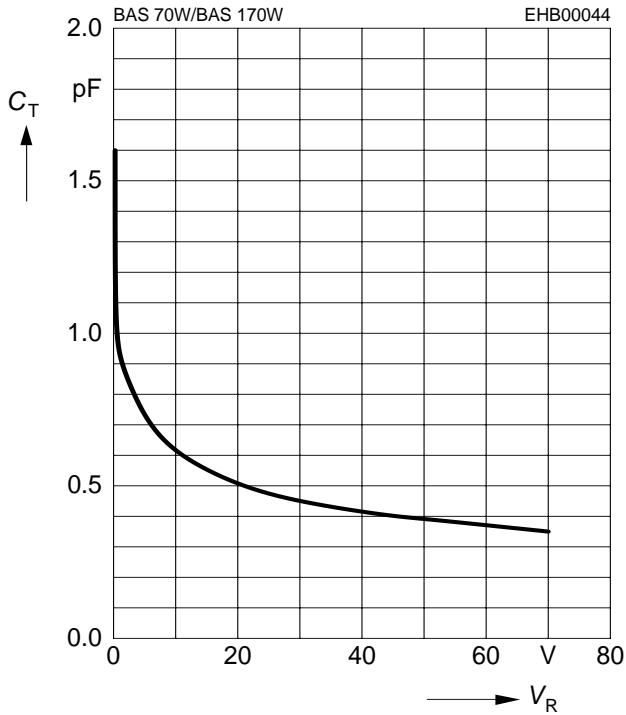

**Forward resistance  $r_f = f(I_F)$**

$f = 10\text{kHz}$

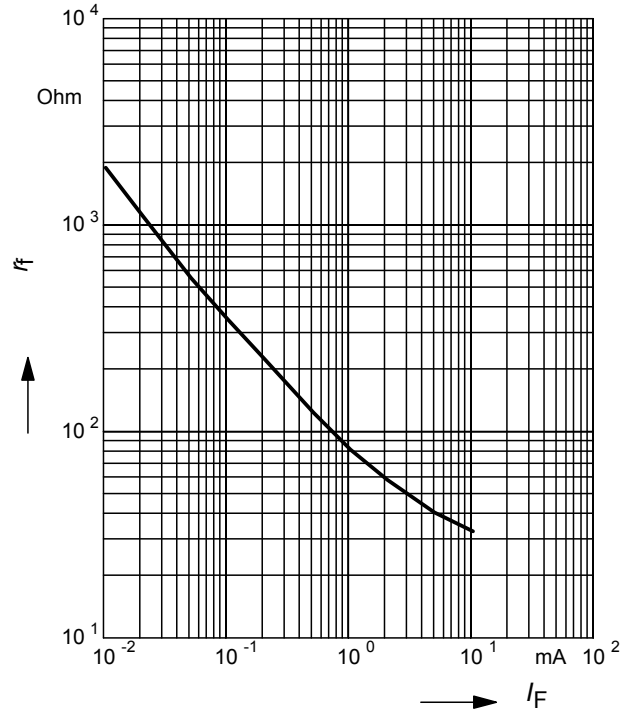

**Reverse current  $I_R = f(V_R)$**

$T_A = \text{Parameter}$

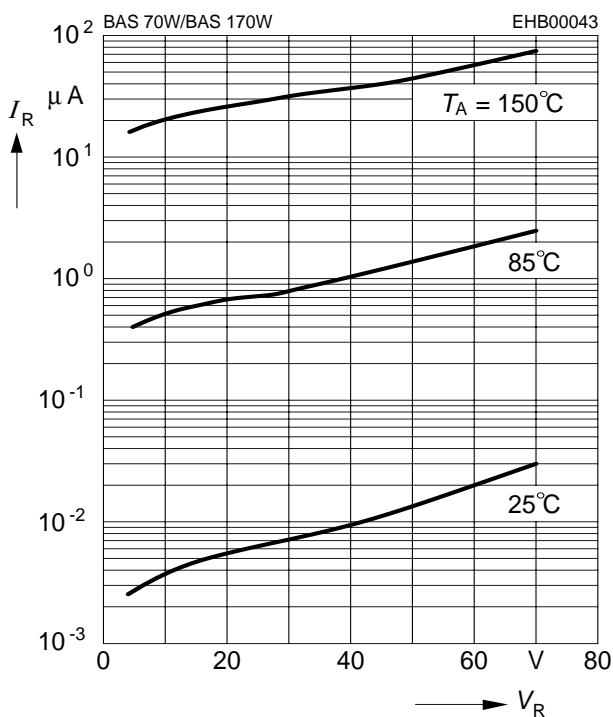

**Forward current  $I_F = f(V_F)$**

$T_A = \text{Parameter}$

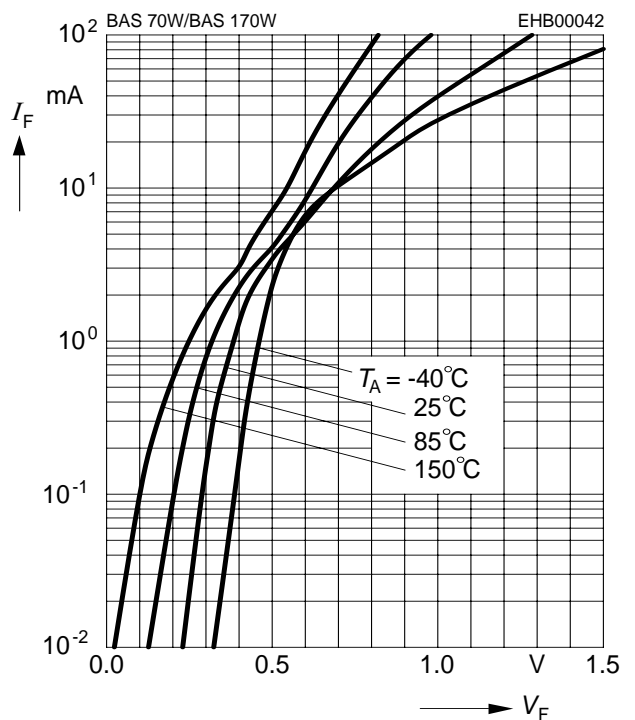

**Forward current  $I_F = f(T_S)$**

BAS70, BAS70-07

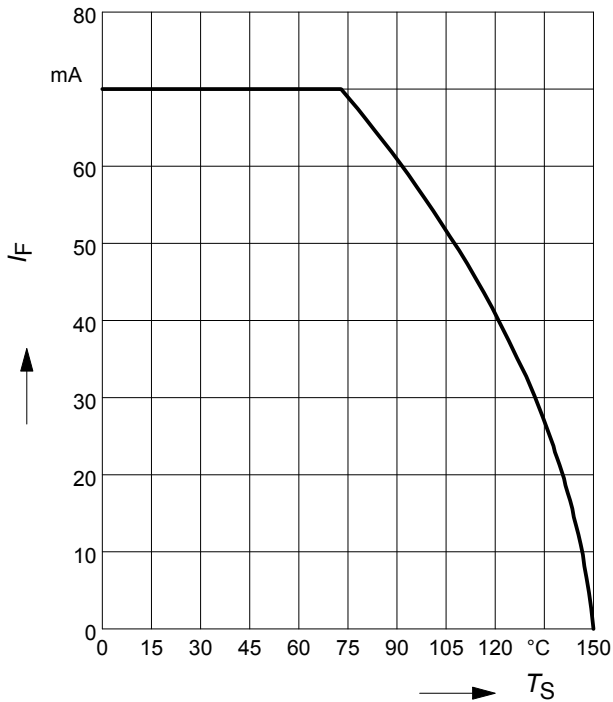

**Forward current  $I_F = f(T_S)$**

BAS70-02L

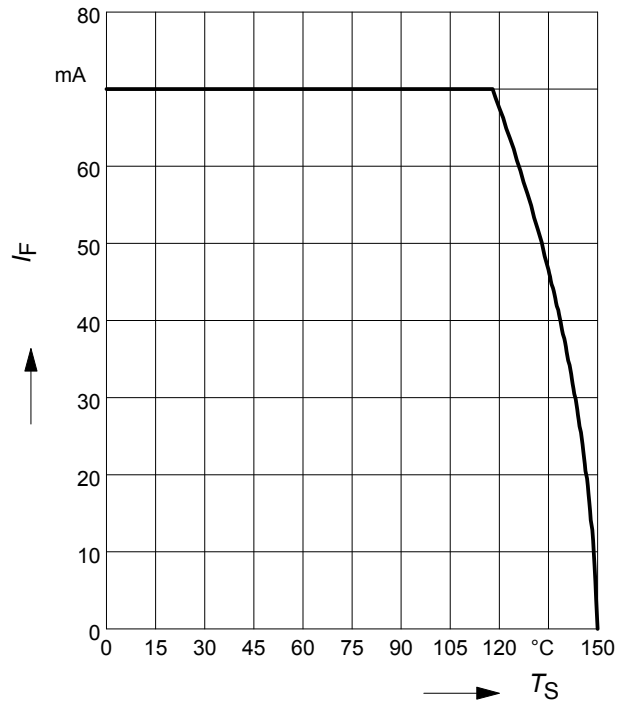

**Forward current  $I_F = f(T_S)$**

BAS70-02W, -02V

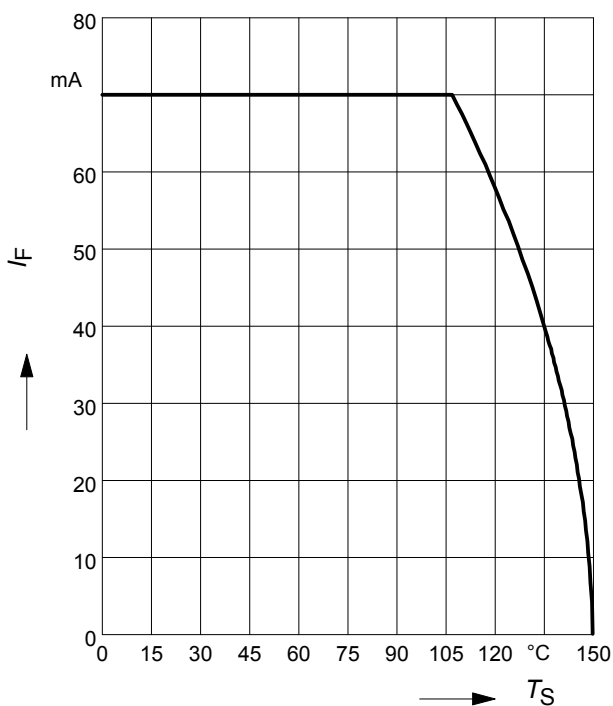

**Forward current  $I_F = f(T_S)$**

BAS70-04, BAS70-06

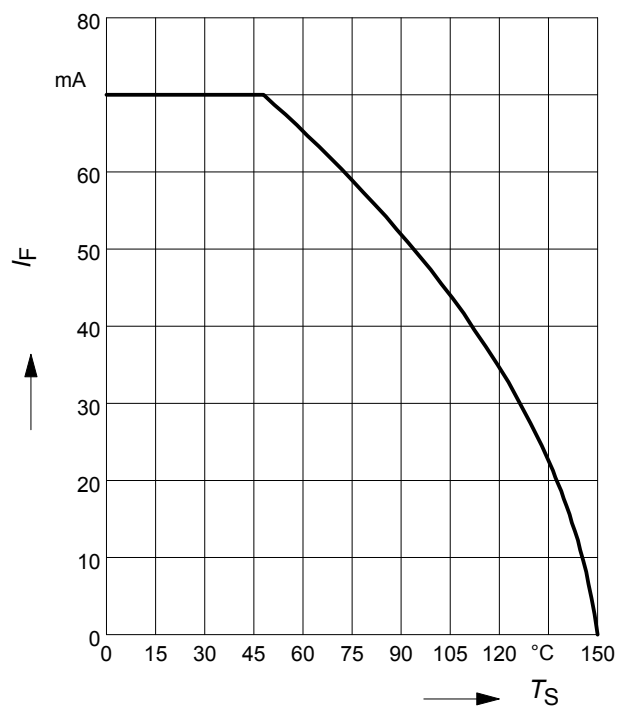

**Forward current  $I_F = f(T_S)$**   
 BAS70-04S/W, BAS70-06W, BAS170W

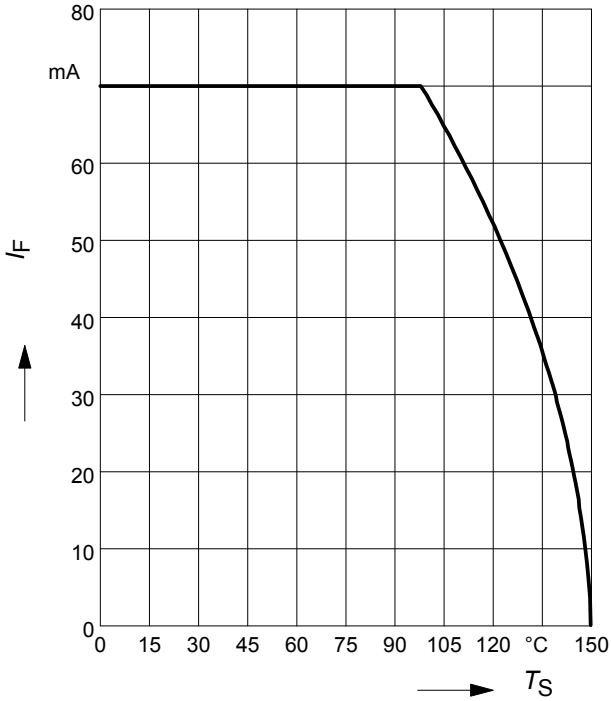

**Forward current  $I_F = f(T_S)$**   
 BAS70-05

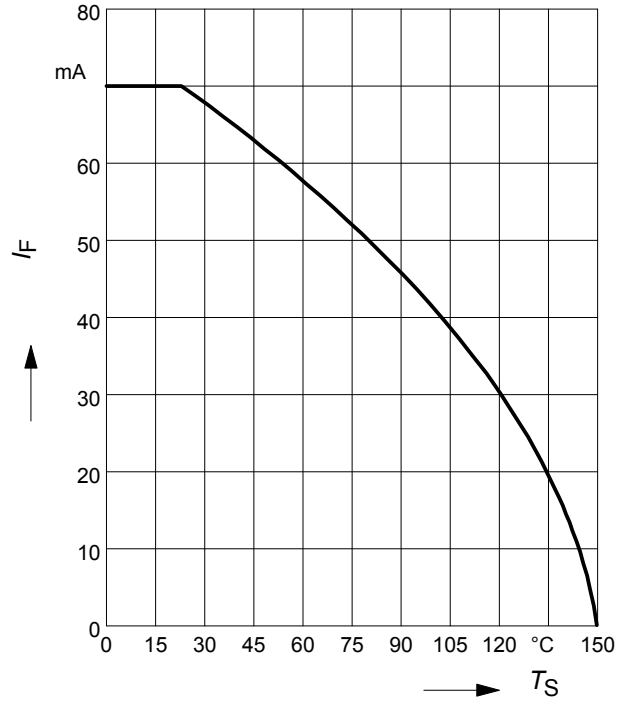

**Forward current  $I_F = f(T_S)$**   
 BAS70-05W

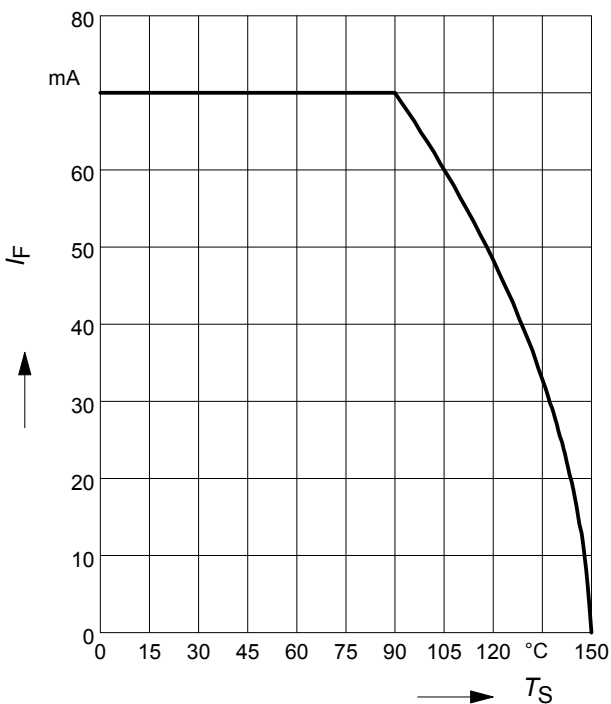

**Forward current  $I_F = f(T_S)$**   
 BAS70-07W

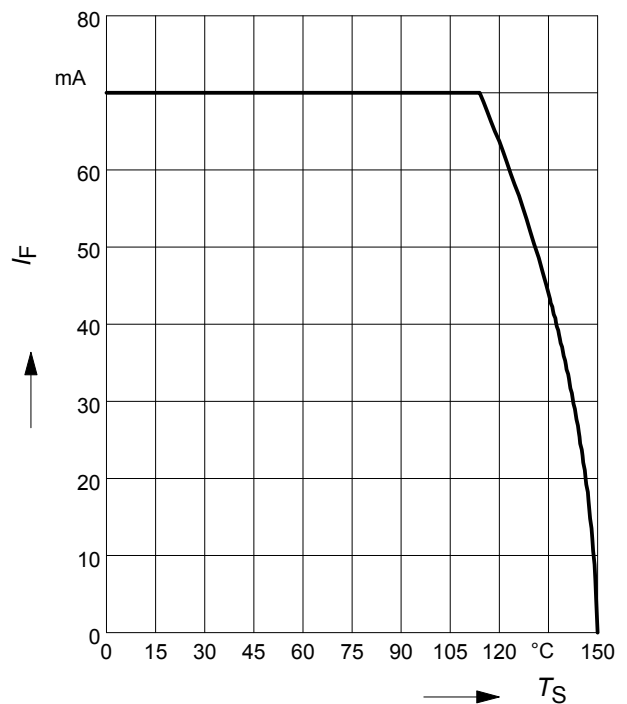

**Forward current  $I_F = f(T_S)$**

BAS170W

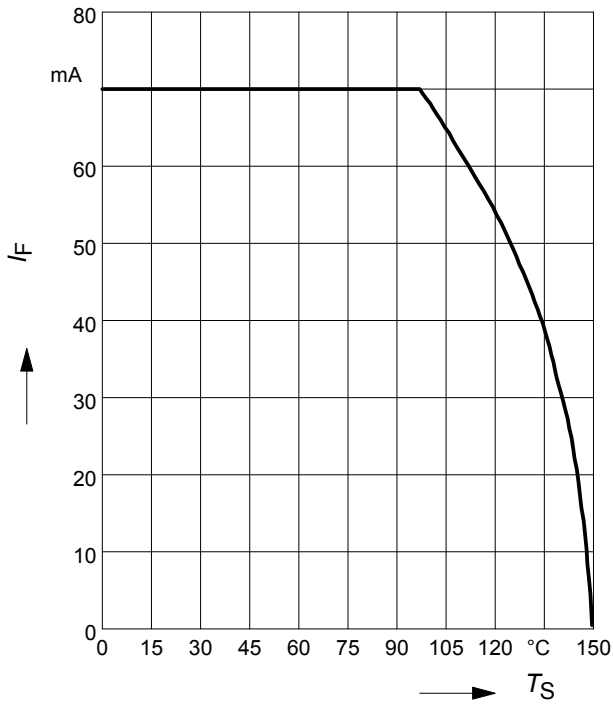

**Permissible Puls Load  $R_{thJS} = f(t_p)$**

BAS70

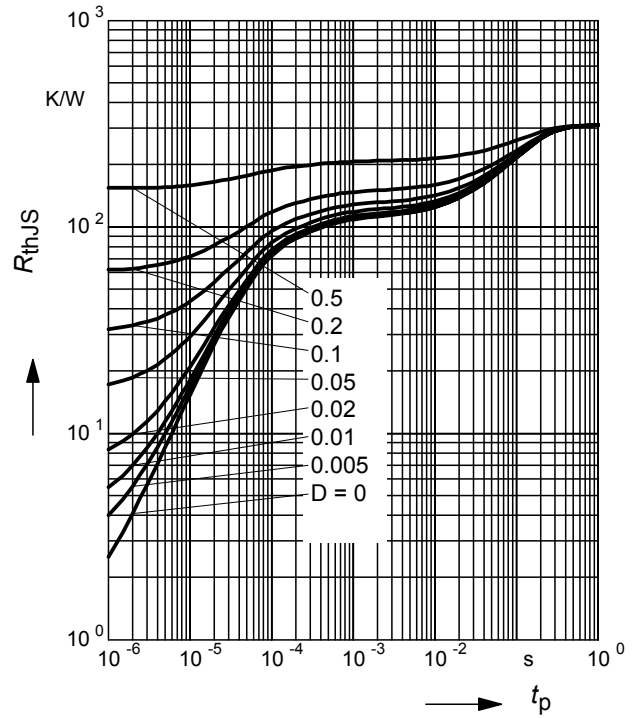

**Permissible Pulse Load**

$I_{Fmax} / I_{FDC} = f(t_p)$

BAS70

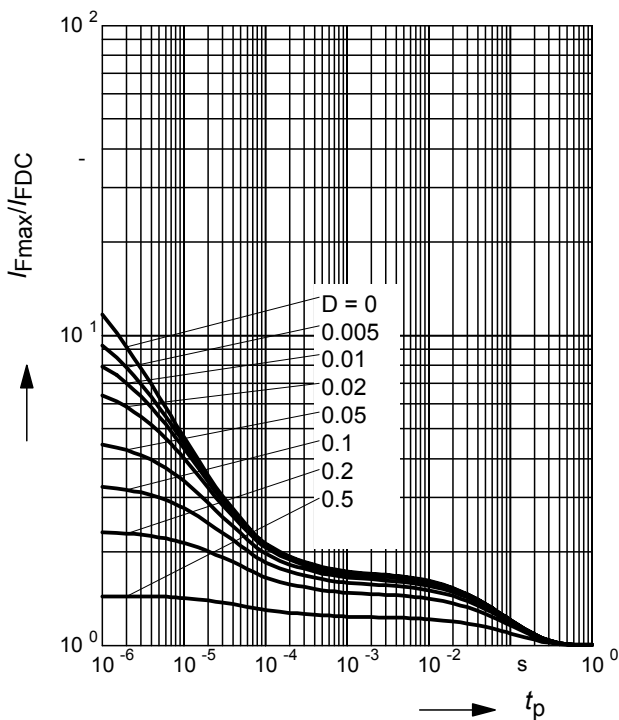

**Permissible Puls Load  $R_{thJS} = f(t_p)$**

BAS70-02L

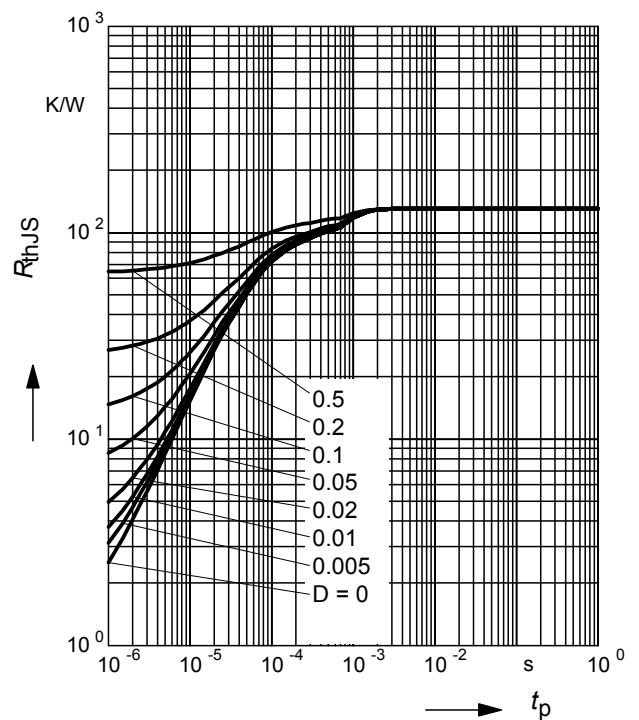

**Permissible Pulse Load**

$I_{Fmax} / I_{FDC} = f(t_p)$

BAS70-02L

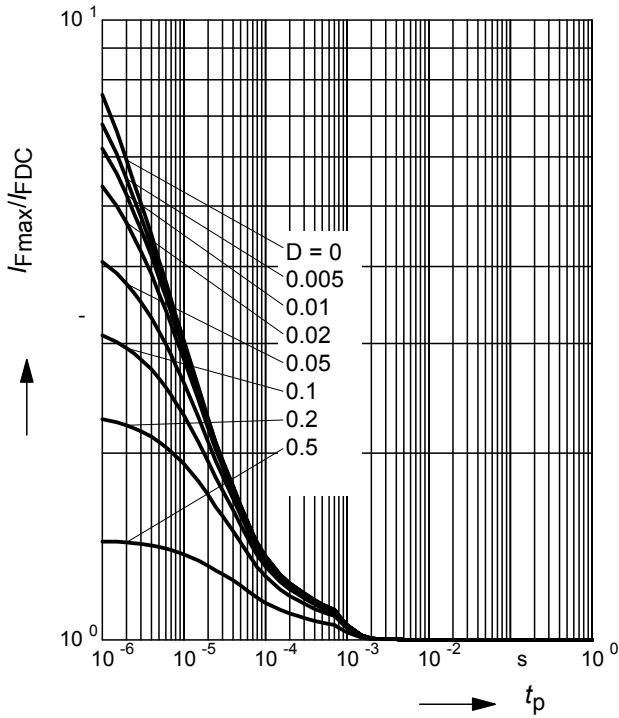

**Permissible Puls Load  $R_{thJS} = f(t_p)$**

BAS70-02W, -02V

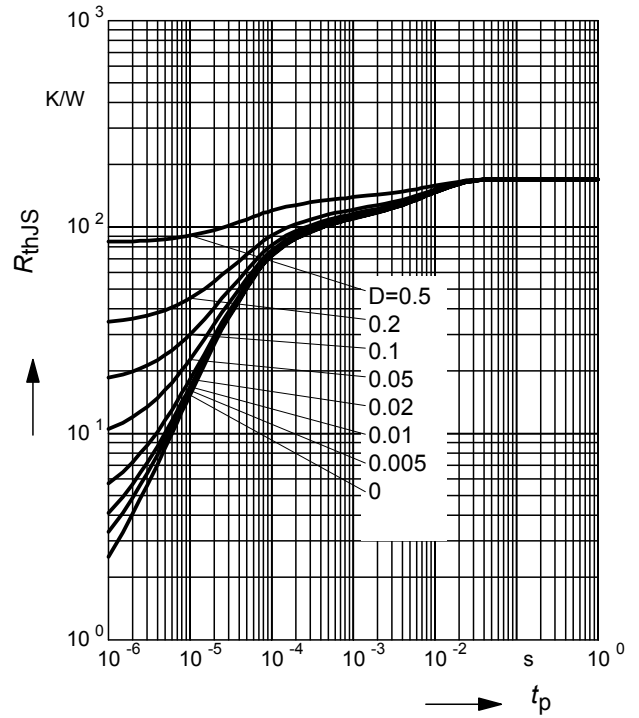

**Permissible Pulse Load**

$I_{Fmax} / I_{FDC} = f(t_p)$

BAS70-02W, -02V

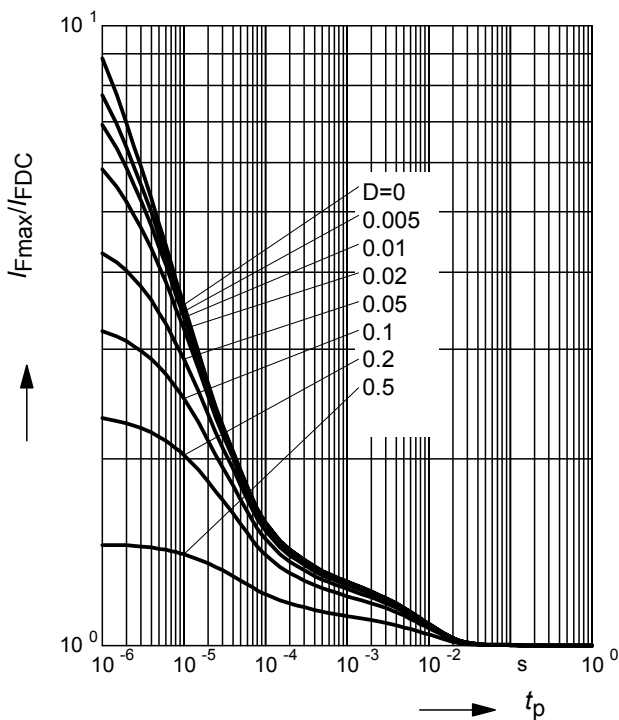

**Permissible Puls Load  $R_{thJS} = f(t_p)$**

BAS70-04, BAS70-06

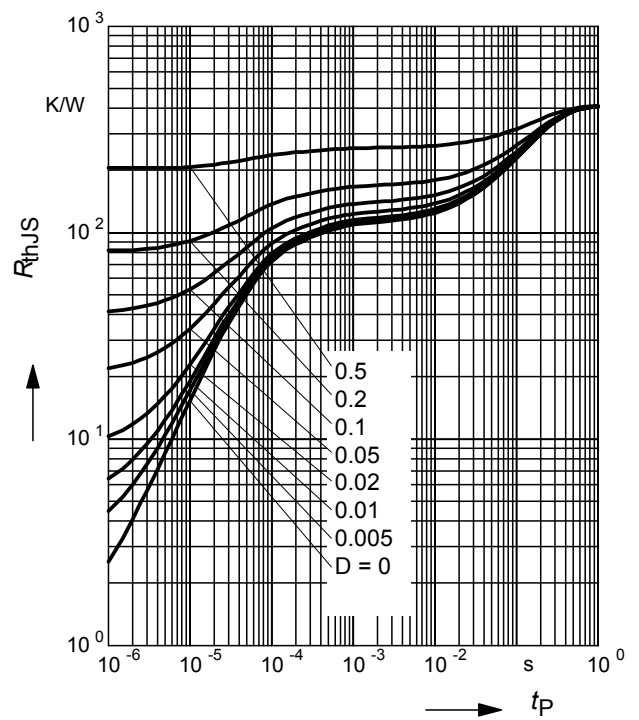

**Permissible Pulse Load**

$$I_{Fmax} / I_{FDC} = f(t_p)$$

BAS70-04, BAS70-06

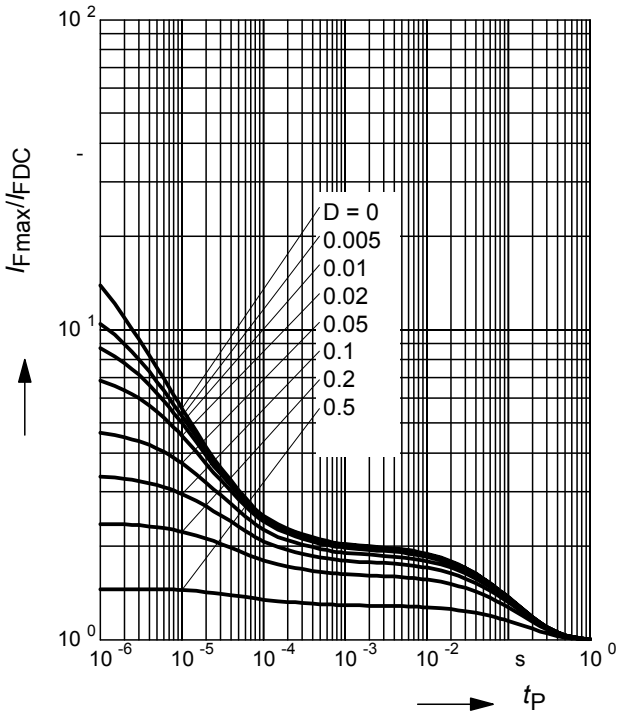

**Permissible Puls Load  $R_{thJS} = f(t_p)$**

BAS70-04S

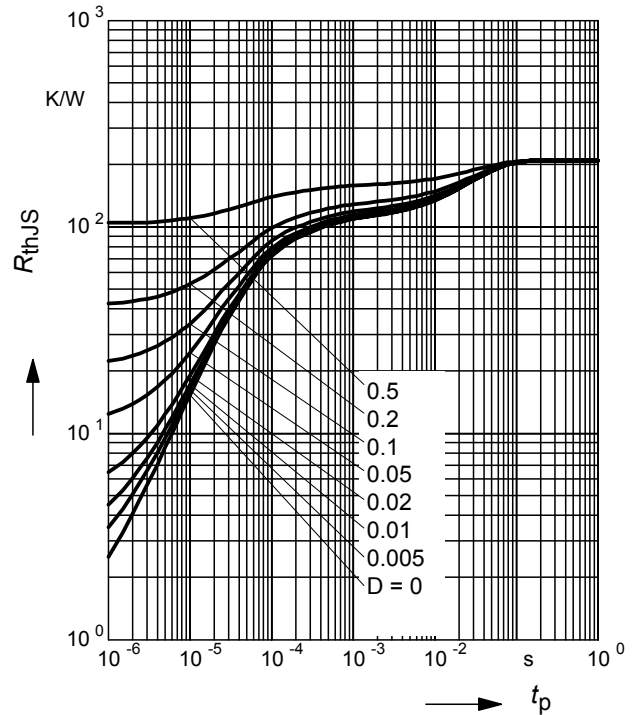

**Permissible Pulse Load**

$$I_{Fmax} / I_{FDC} = f(t_p)$$

BAS70-04S

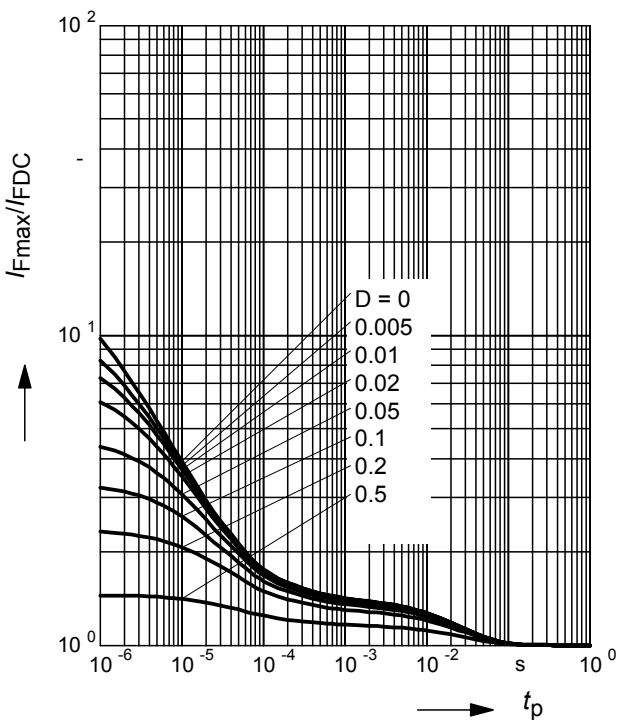

**Permissible Puls Load  $R_{thJS} = f(t_p)$**

BAS70-04W, BAS70-06W

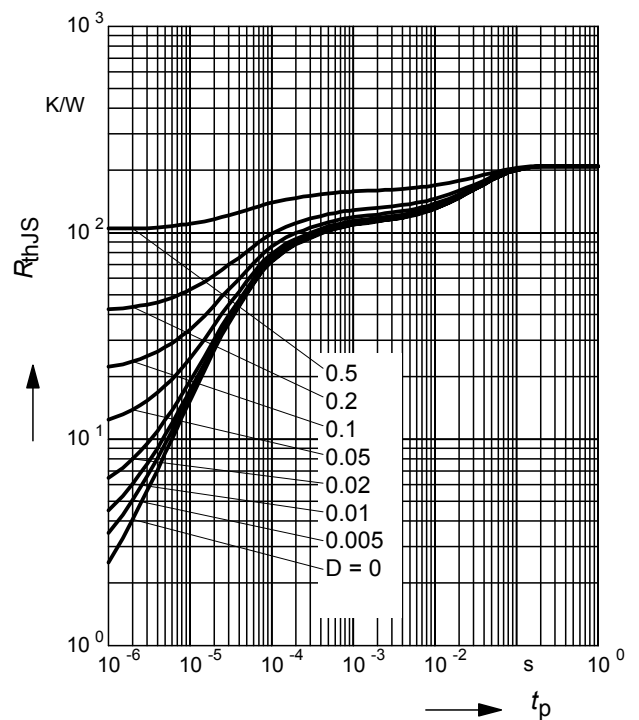

**Permissible Pulse Load**

$I_{Fmax} / I_{FDC} = f(t_p)$

BAS70-04W, BAS70-06W

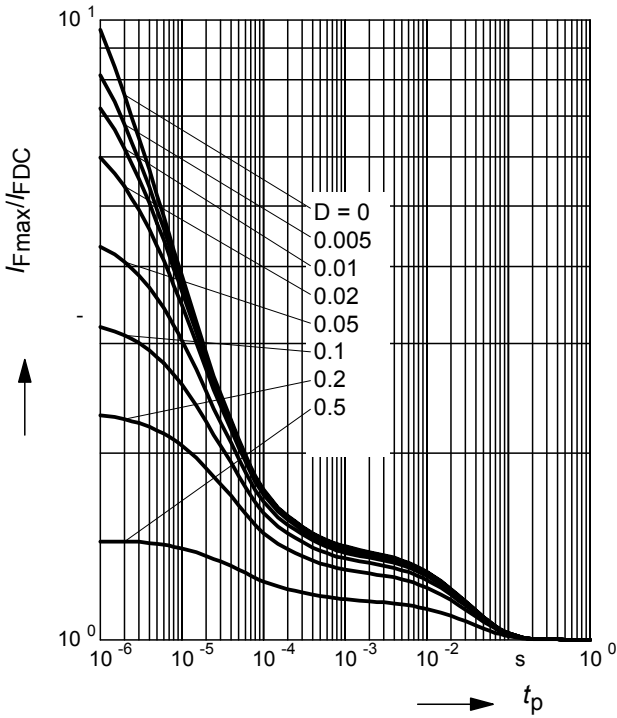

**Permissible Puls Load  $R_{thJS} = f(t_p)$**

BAS70-05



**Permissible Pulse Load**

$I_{Fmax} / I_{FDC} = f(t_p)$

BAS70-05

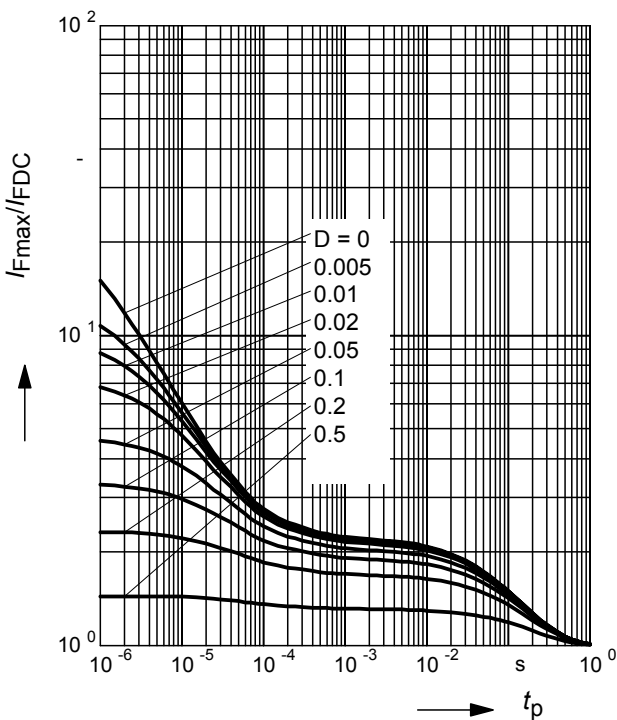

**Permissible Puls Load  $R_{thJS} = f(t_p)$**

BAS70-05W



**Permissible Pulse Load**

$$I_{Fmax} / I_{FDC} = f(t_p)$$

BAS70-05W

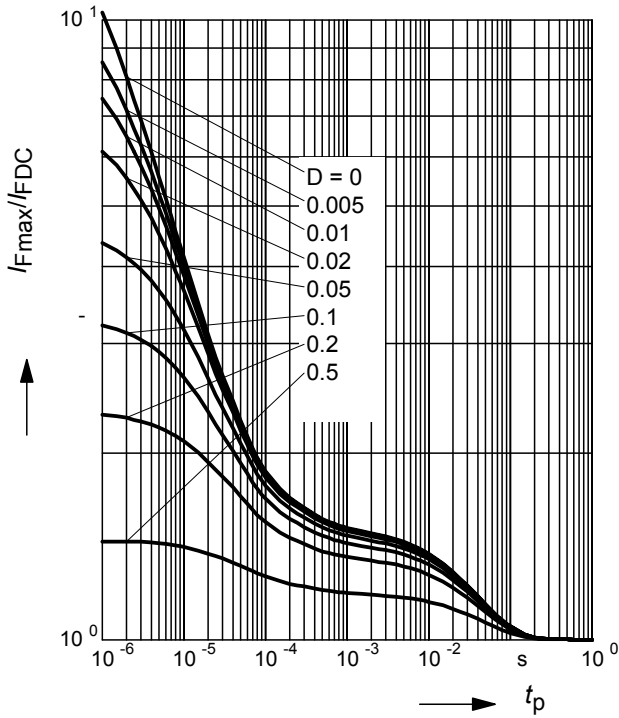

**Permissible Puls Load  $R_{thJS} = f(t_p)$**

BAS70-07W



**Permissible Pulse Load**

$$I_{Fmax} / I_{FDC} = f(t_p)$$

BAS70-07W

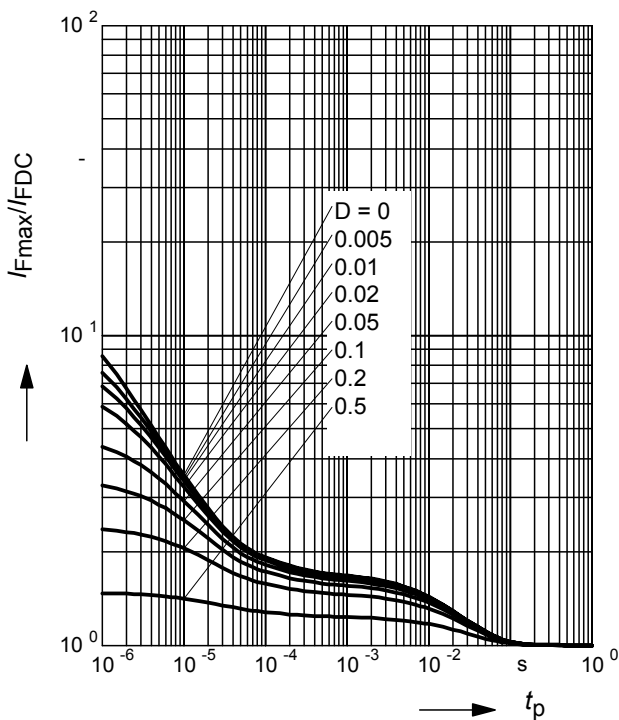

**Permissible Puls Load  $R_{thJS} = f(t_p)$**

BAS170W

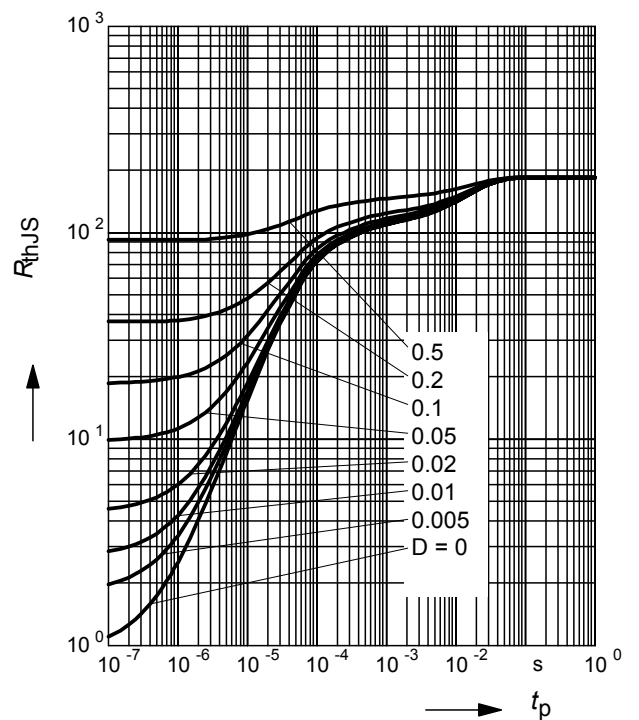

**Permissible Pulse Load**

$$I_{Fmax}/I_{FDC} = f(t_p)$$

BAS170W

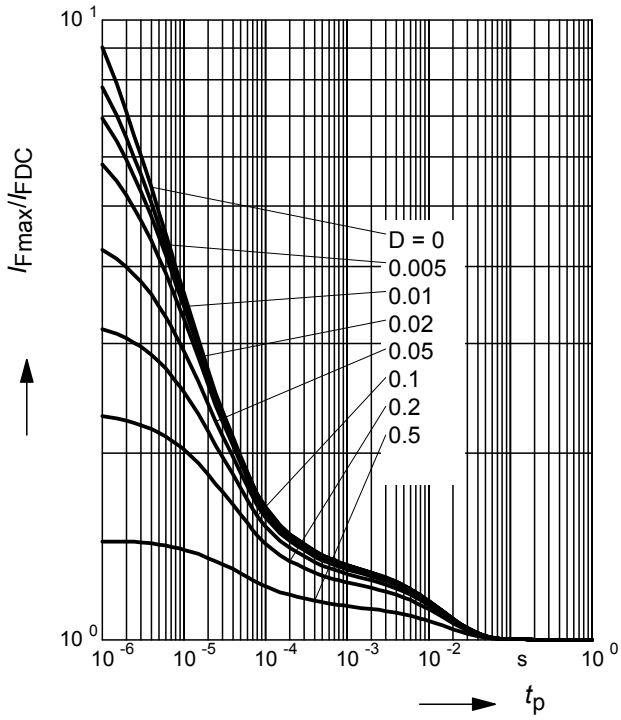

### Package Outline

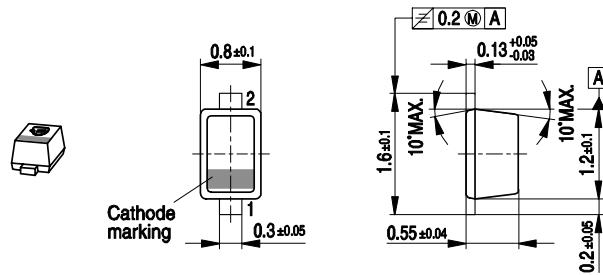

### Foot Print

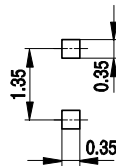

### Marking Layout (Example)

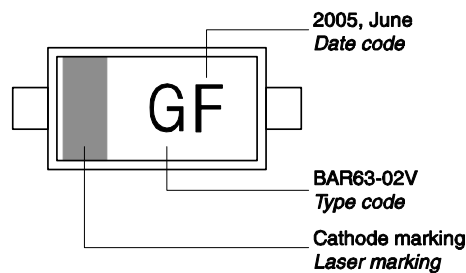

### Standard Packing

- Reel ø180 mm = 3.000 Pieces/Reel
- Reel ø180 mm = 8.000 Pieces/Reel (2 mm Pitch)
- Reel ø330 mm = 10.000 Pieces/Reel

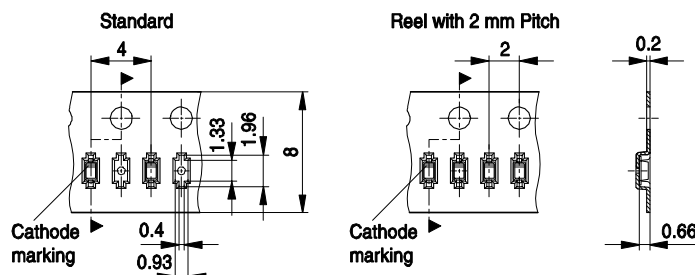

Package Outline

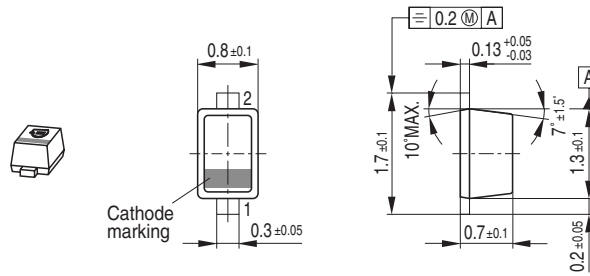

Foot Print

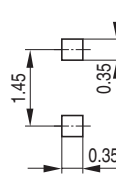

Marking Layout (Example)

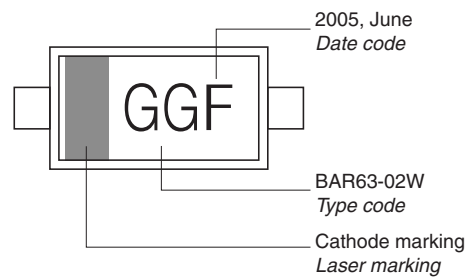

Standard Packing

Reel  $\varnothing$ 180 mm = 3.000 Pieces/Reel  
 Reel  $\varnothing$ 180 mm = 8.000 Pieces/Reel (2 mm Pitch)  
 Reel  $\varnothing$ 330 mm = 10.000 Pieces/Reel

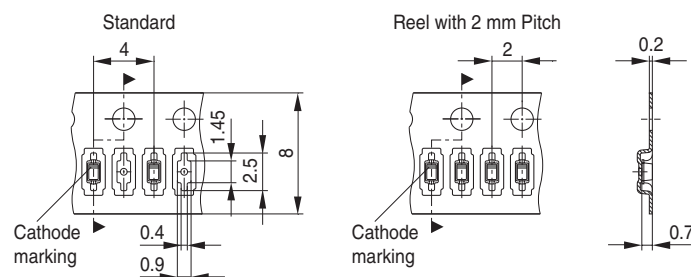

Date Code marking for discrete packages with one digit (SCD80, SC79, SC75<sup>1)</sup>) CES-Code

| Month | 2003 | 2004 | 2005 | 2006 | 2007 | 2008 | 2009 | 2010 | 2011 | 2012 | 2013 | 2014 |
|-------|------|------|------|------|------|------|------|------|------|------|------|------|
| 01    | a    | p    | A    | P    | a    | p    | A    | P    | a    | p    | A    | P    |
| 02    | b    | q    | B    | Q    | b    | q    | B    | Q    | b    | q    | B    | Q    |
| 03    | c    | r    | C    | R    | c    | r    | C    | R    | c    | r    | C    | R    |
| 04    | d    | s    | D    | S    | d    | s    | D    | S    | d    | s    | D    | S    |
| 05    | e    | t    | E    | T    | e    | t    | E    | T    | e    | t    | E    | T    |
| 06    | f    | u    | F    | U    | f    | u    | F    | U    | f    | u    | F    | U    |
| 07    | g    | v    | G    | V    | g    | v    | G    | V    | g    | v    | G    | V    |
| 08    | h    | x    | H    | X    | h    | x    | H    | X    | h    | x    | H    | X    |
| 09    | j    | y    | J    | Y    | j    | y    | J    | Y    | j    | y    | J    | Y    |
| 10    | k    | z    | K    | Z    | k    | z    | K    | Z    | k    | z    | K    | Z    |
| 11    | l    | 2    | L    | 4    | l    | 2    | L    | 4    | l    | 2    | L    | 4    |
| 12    | n    | 3    | N    | 5    | n    | 3    | N    | 5    | n    | 3    | N    | 5    |

1) New Marking Layout for SC75, implemented at October 2005.

Package Outline

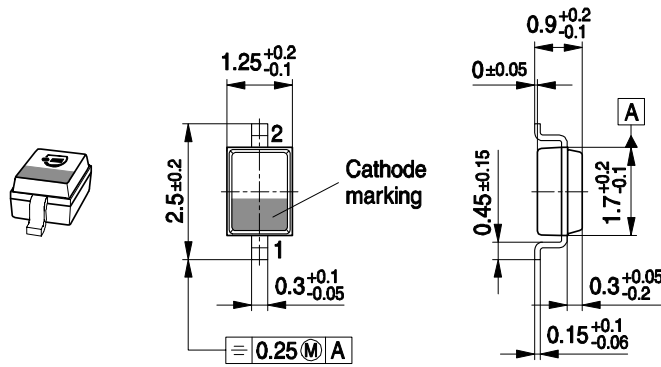

Foot Print

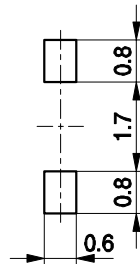

Marking Layout (Example)

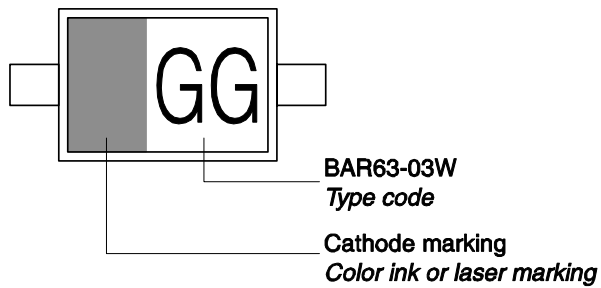

Standard Packing

Reel ø180 mm = 3.000 Pieces/Reel  
 Reel ø330 mm = 10.000 Pieces/Reel

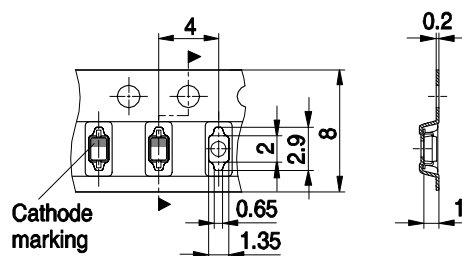

### Package Outline

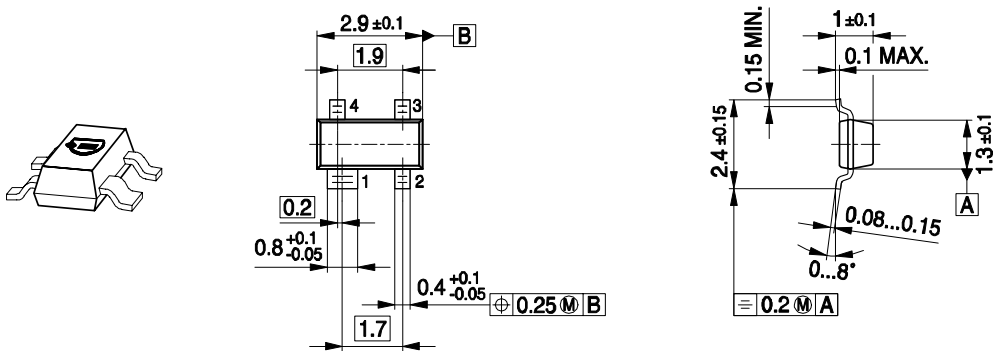

Note: Mold flash, protrusions or gate burrs of 0,2 mm max. per side are not included

SOT143-PO V09

### Foot Print

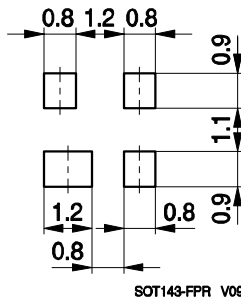

### Marking Layout (Example)

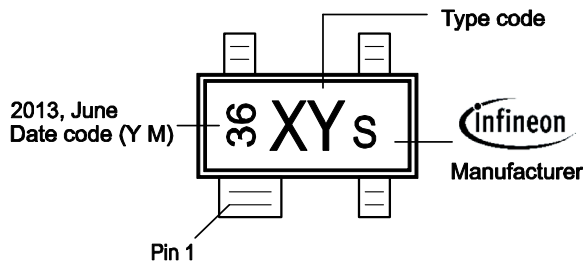

### Standard Packing

Reel ø180 mm = 3.000 Pieces/Reel  
 Reel ø330 mm = 10.000 Pieces/Reel

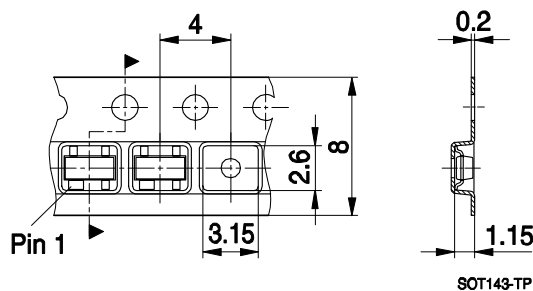

Package Outline

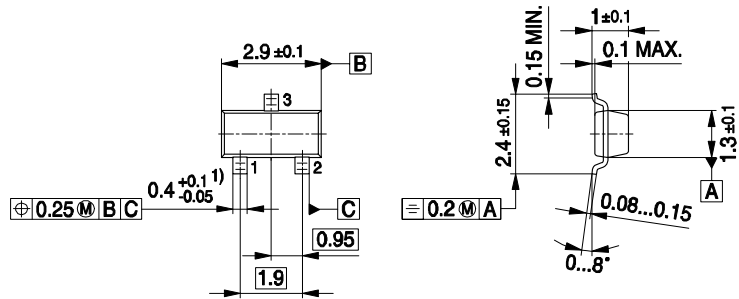
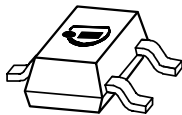

1) Lead width can be 0.6 max. in dambar area

SOT23-PO V08

Foot Print

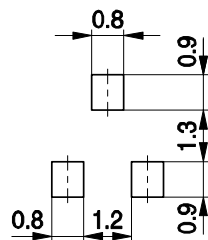

SOT23-FPR V08

Marking Layout

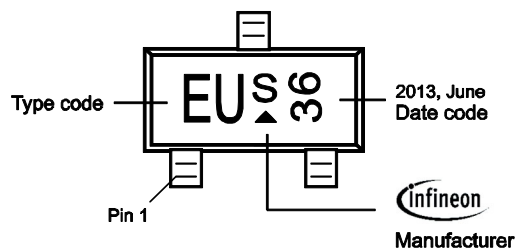

Standard Packing

Reel o 180 mm: 3.000 Pieces / Reel  
 Reel o 330 mm = 10.000 Pieces / Reel

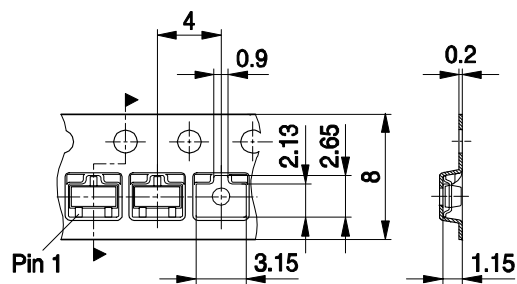

SOT23-TP V02

### Package Outline

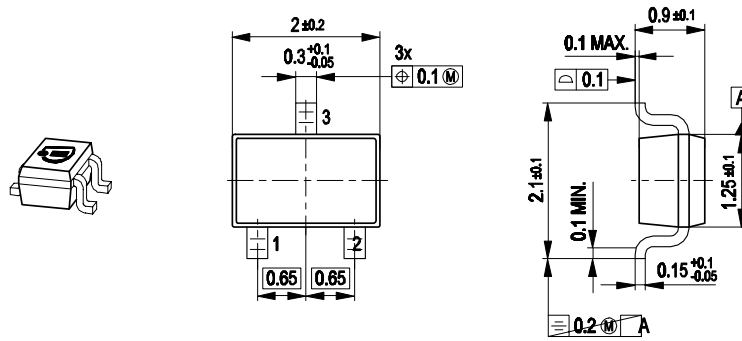

### Foot Print

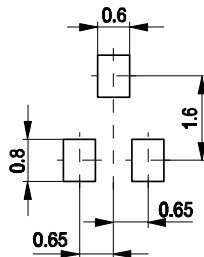

### Marking Layout (Example)

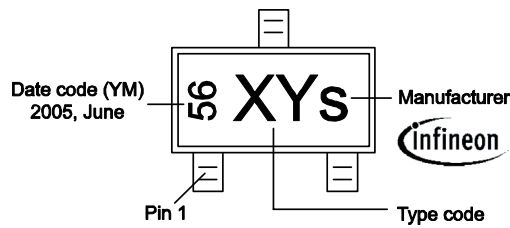

### Standard Packing

Reel ø180 mm = 3.000 Pieces/Reel  
 Reel ø330 mm = 10.000 Pieces/Reel

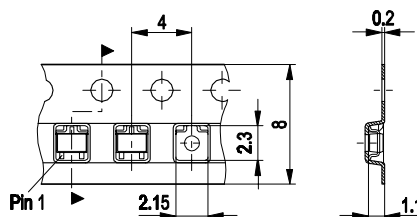

Package Outline

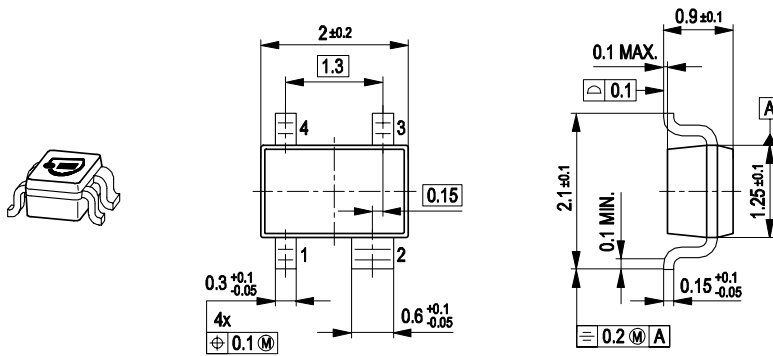

Foot Print

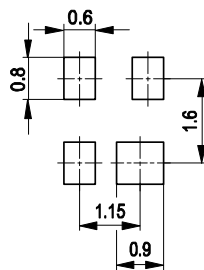

Marking Layout (Example)

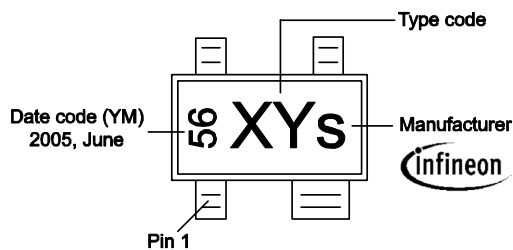

Standard Packing

Reel ø180 mm = 3.000 Pieces/Reel  
 Reel ø330 mm = 10.000 Pieces/Reel

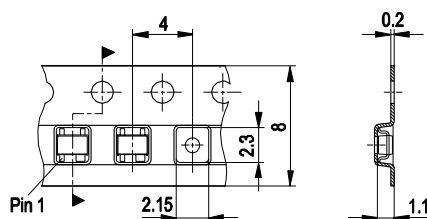

### Package Outline

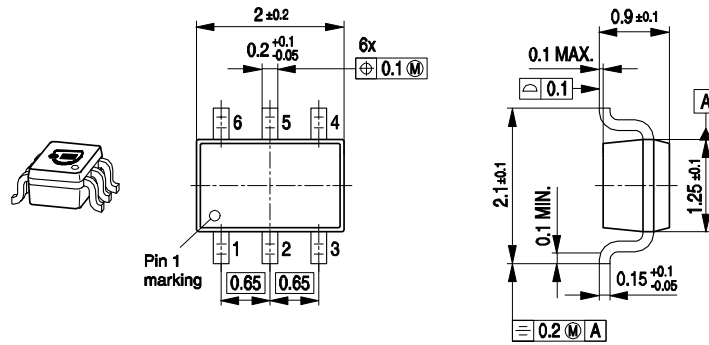

### Foot Print

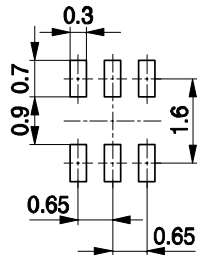

### Marking Layout (Example)

Small variations in positioning of Date code, Type code and Manufacture are possible.

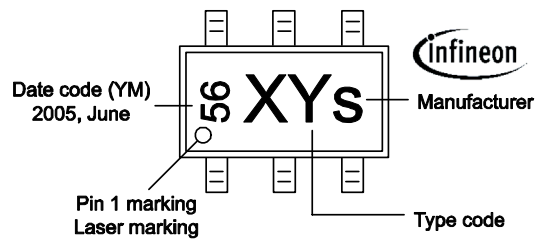

### Standard Packing

Reel  $\varnothing$ 180 mm = 3.000 Pieces/Reel  
 Reel  $\varnothing$ 330 mm = 10.000 Pieces/Reel

For symmetric types no defined Pin 1 orientation in reel.

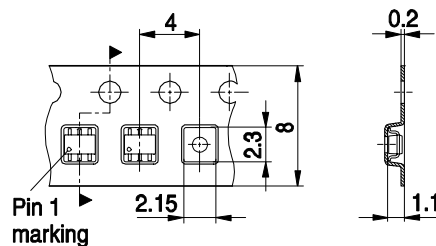

### Package Outline

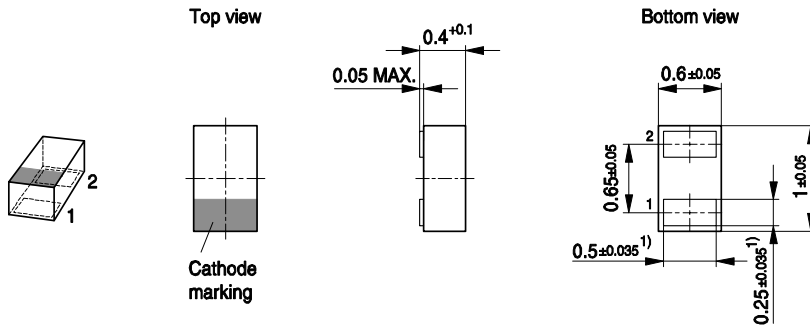

1) Dimension applies to plated terminal

### Foot Print

For board assembly information please refer to Infineon website "Packages"

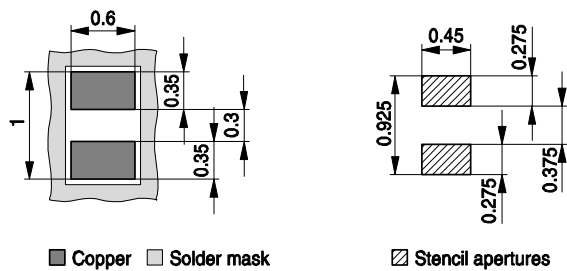

■ Copper □ Solder mask ▨ Stencil apertures

### Marking Layout (Example)

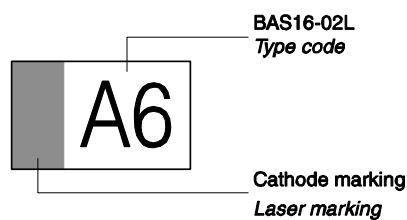

### Standard Packing

Reel ø180 mm = 15.000 Pieces/Reel  
 Reel ø330 mm = 50.000 Pieces/Reel (optional)

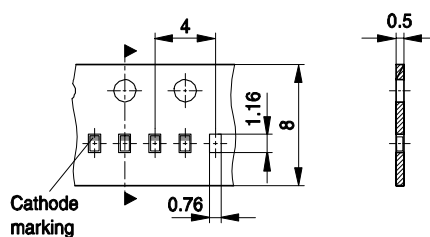

**Edition 2009-11-16**

**Published by  
Infineon Technologies AG  
81726 Munich, Germany**

**© 2009 Infineon Technologies AG  
All Rights Reserved.**

### **Legal Disclaimer**

The information given in this document shall in no event be regarded as a guarantee of conditions or characteristics. With respect to any examples or hints given herein, any typical values stated herein and/or any information regarding the application of the device, Infineon Technologies hereby disclaims any and all warranties and liabilities of any kind, including without limitation, warranties of non-infringement of intellectual property rights of any third party.

### **Information**

For further information on technology, delivery terms and conditions and prices, please contact the nearest Infineon Technologies Office ([www.infineon.com](http://www.infineon.com)).

### **Warnings**

Due to technical requirements, components may contain dangerous substances. For information on the types in question, please contact the nearest Infineon Technologies Office.

Infineon Technologies components may be used in life-support devices or systems only with the express written approval of Infineon Technologies, if a failure of such components can reasonably be expected to cause the failure of that life-support device or system or to affect the safety or effectiveness of that device or system. Life support devices or systems are intended to be implanted in the human body or to support and/or maintain and sustain and/or protect human life. If they fail, it is reasonable to assume that the health of the user or other persons may be endangered.

## Looking for pricing, stock, or lifecycle information?

Click below to explore more details on WIN SOURCE:

- ⊖ [View BAS7002WH6327XTSA1 on WIN SOURCE](#)
- ⊖ [Infineon Technologies Information](#)

## Optimize Your Supply Chain with WIN SOURCE Solutions

- ✓ Global Sourcing Solution
- ✓ Obsolete Management
- ✓ Cost Control Management
- ✓ Shortage Management
- ✓ Alternative Solution
- ✓ Excess Inventory Management