



THE DATASHEET OF BAS69-07P6FILM



Low capacitance small signal Schottky diodes

Features

- Low diode capacitance
- Designed for RF applications
- Low profile packages
- Very low parasitic inductor and resistor

Description

The BAS69 series use 15V barrier, with extremely low junction capacitance, suitable for the detection of an RF signal and the compensation of the voltage drift with the temperature. The presented packages make the device ideal in applications where space saving is critical.

The low junction capacitance will reduce the disturbance on the RF signal.

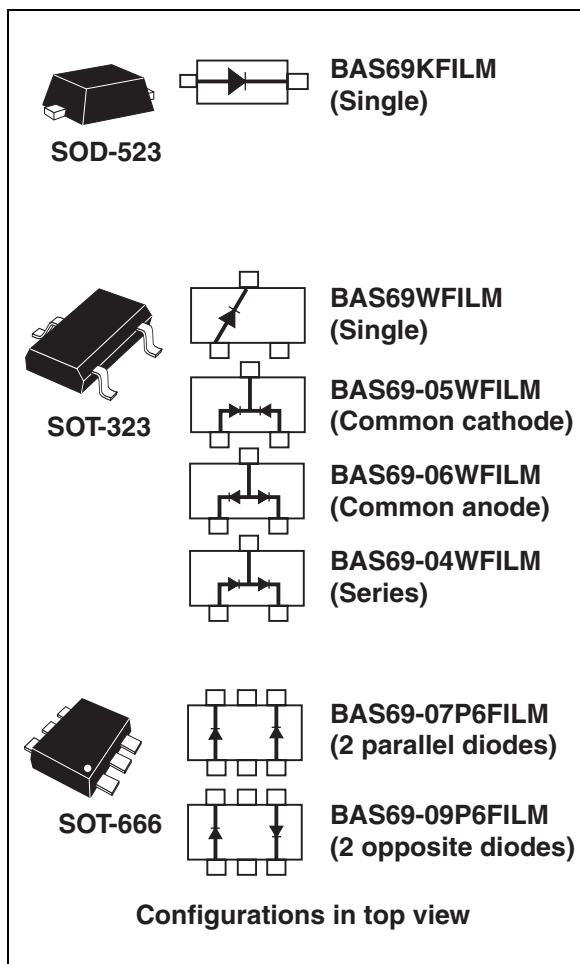

Table 1. Device summary

Symbol	Value
I_F	10 mA
V_{RRM}	15 V
C (typ)	< 1 pF
T_j (max)	150 °C

1 Characteristics

Table 2. Absolute ratings (limiting values at $T_j = 25\text{ °C}$, unless otherwise specified)

Symbol	Parameter		Value	Unit
V_{RRM}	Repetitive peak reverse voltage		15	V
I_F	Continuous forward current		10	mA
I_{FSM}	Surge non repetitive forward current	Half wave, single phase 60 Hz	2	A
T_{stg}	Storage temperature range		-65 to +150	°C
T_j	Maximum operating junction temperature ⁽¹⁾		150	
T_L	Maximum soldering temperature ⁽¹⁾		260	

1. Pulse test: $t_p = 380\ \mu\text{s}$, $\delta < 2\%$

Table 3. Thermal parameters

Symbol	Parameter		Value	Unit
$R_{th(j-a)}$	Junction to ambient ⁽¹⁾	SOT-323	550	°C/W
		SOD-523, SOT-666	600	

1. Epoxy printed circuit board with recommended pad layout

Table 4. Static electrical characteristics

Symbol	Parameter	Test conditions		Min.	Typ	Max.	Unit
$I_R^{(1)}$	Reverse leakage current	$T_j = 25\text{ °C}$	$V_R = 1\text{ V}$			0.035	μA
		$T_j = 125\text{ °C}$			6	30	
		$T_j = 25\text{ °C}$	$V_R = 15\text{ V}$			0.23	
		$T_j = 125\text{ °C}$			10	100	
$V_F^{(1)}$	Forward voltage drop	$T_j = 25\text{ °C}$	$I_F = 1\text{ mA}$		350	380	mV
		$T_j = 125\text{ °C}$			230	260	
		$T_j = 25\text{ °C}$	$I_F = 10\text{ mA}$		500	570	
		$T_j = 125\text{ °C}$			460	510	

1. Pulse test: $t_p \leq 250\text{ ms}$, $\delta \leq 2\%$

Table 5. Dynamic characteristics

Symbol	Parameter	Test conditions	Min.	Typ	Max.	Unit
C	Diode capacitance	$V_R = 0\text{ V}$, $F = 1\text{ MHz}$			1.0	pF
R_F	Forward resistance	$I_F = 5\text{ mA}$, $F = 100\text{ MHz}$		15		Ω
L_S	Series inductance			1.5		nH

Figure 1. Forward voltage drop versus forward current (typical values)

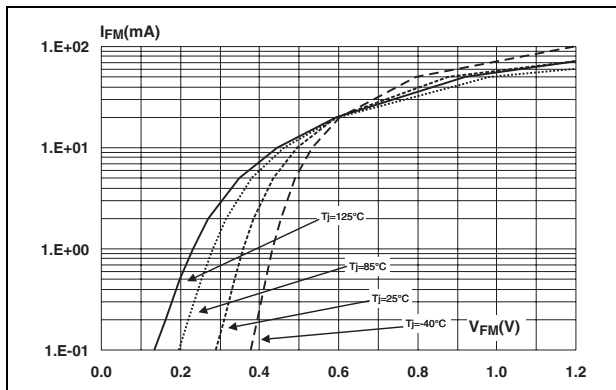

Figure 2. Reverse leakage current versus reverse voltage applied (typical values)

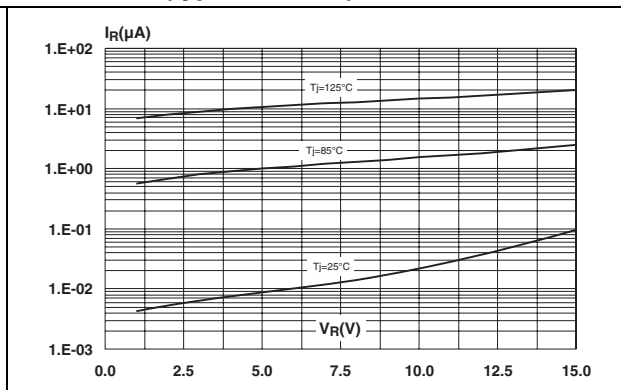

Figure 3. Differential forward resistance versus forward current (typical values)

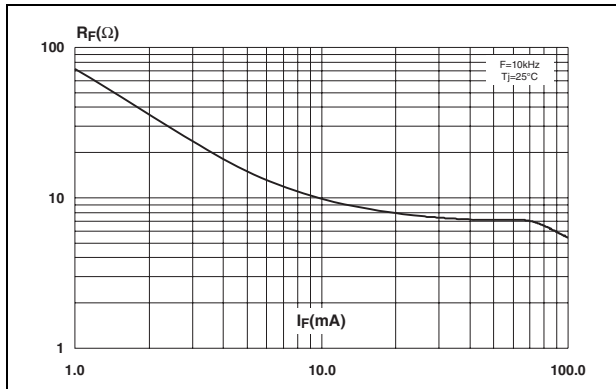

Figure 4. Junction capacitance versus reverse voltage applied (typical values)

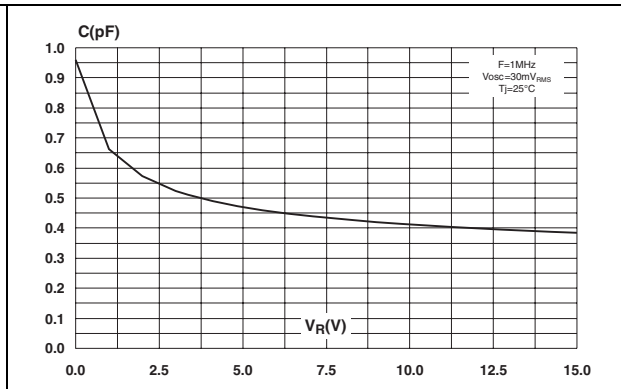

Figure 5. Relative variation of thermal impedance junction to ambient versus pulse duration (SOT-323)

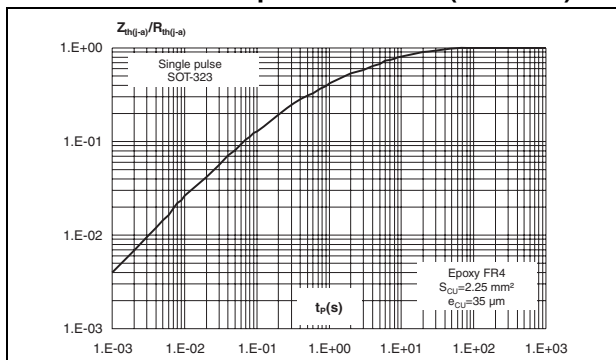

Figure 6. Relative variation of thermal impedance junction to ambient versus pulse duration (SOT-666)

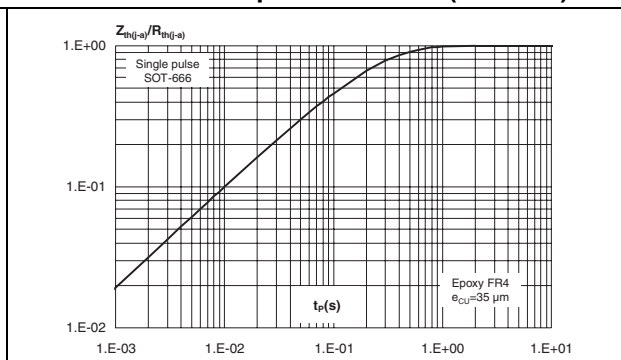

Figure 7. Relative variation of thermal impedance junction to ambient versus pulse duration (SOD-523)

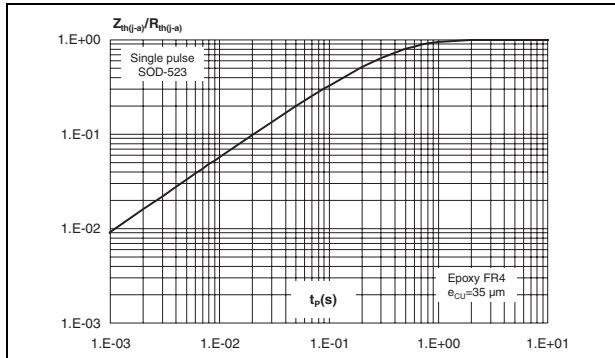
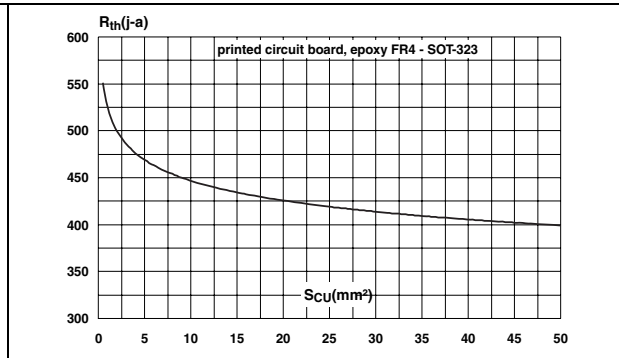
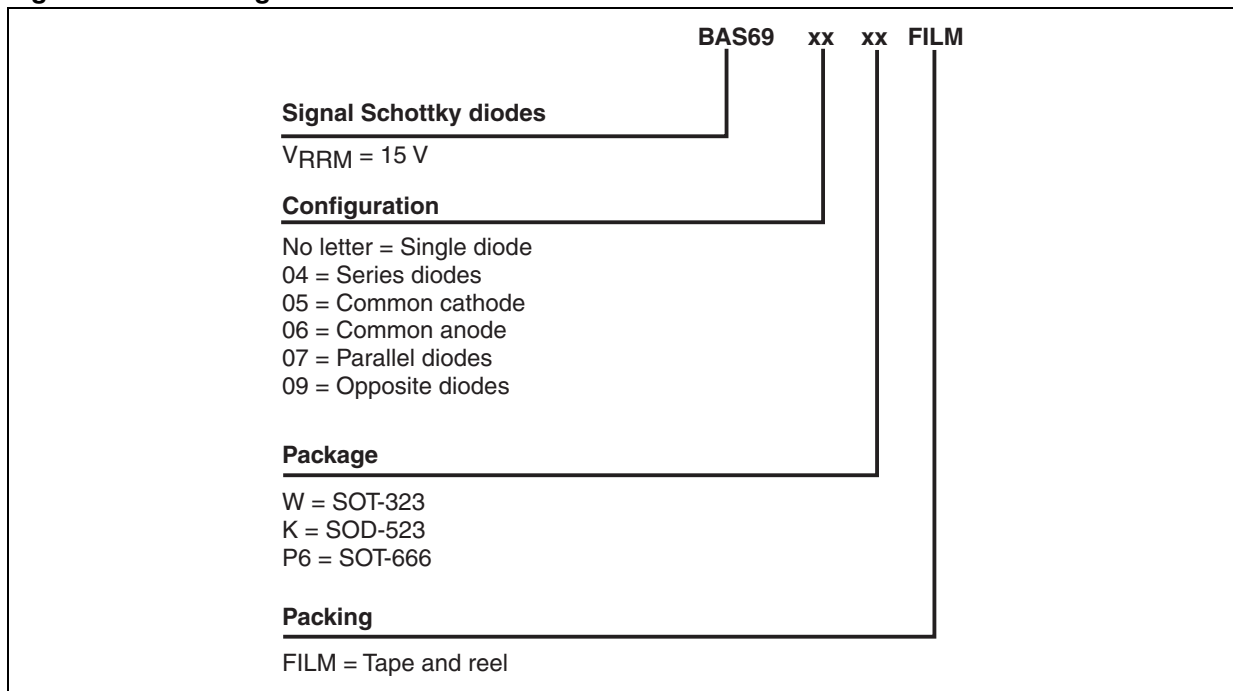

Figure 8. Thermal resistance junction to ambient versus copper surface under each lead



2 Ordering information scheme

Figure 9. Ordering information scheme



3 Package information

- Epoxy meets UL94, V0
- Lead-free packages

In order to meet environmental requirements, ST offers these devices in different grades of ECOPACK[®] packages, depending on their level of environmental compliance. ECOPACK[®] specifications, grade definitions and product status are available at: www.st.com. ECOPACK[®] is an ST trademark.

Table 6. SOD-523 dimensions

Ref.	Dimensions					
	Millimeters			Inches		
	Min.	Typ.	Max.	Min.	Typ.	Max.
A	0.50	0.60	0.70	0.020	0.024	0.028
E	1.50	1.60	1.70	0.059	0.063	0.067
E1	1.10	1.20	1.30	0.043	0.047	0.051
D	0.70	0.80	0.90	0.028	0.031	0.035
b	0.25		0.35	0.010		0.014
c	0.07		0.20	0.003		0.008
L	0.15	0.20	0.25	0.006	0.008	0.010
L1	0.05		0.20	0.002		0.008

Figure 10. SOD-523 footprint (dimensions in mm)

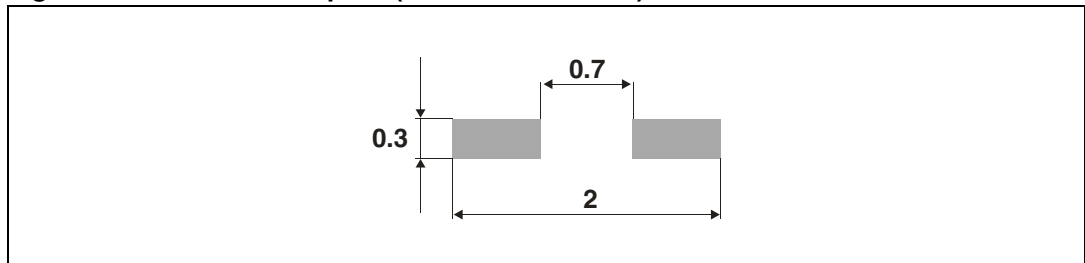

Table 7. SOT-323 dimensions

Ref.	Dimensions					
	Millimeters			Inches		
	Min.	Typ.	Max.	Min.	Typ.	Max.
A	0.8		1.1	0.031		0.043
A1	0.0		0.1	0.0		0.004
b	0.25		0.4	0.010		0.016
c	0.1		0.26	0.004		0.010
D	1.8	2.0	2.2	0.071	0.079	0.086
E	1.15	1.25	1.35	0.045	0.049	0.053
e		0.65			0.026	
H	1.8	2.1	2.4	0.071	0.083	0.094
L	0.1	0.2	0.3	0.004	0.008	0.012
q	0		30°	0		30°

Figure 11. SOT-323 footprint (dimensions in mm)

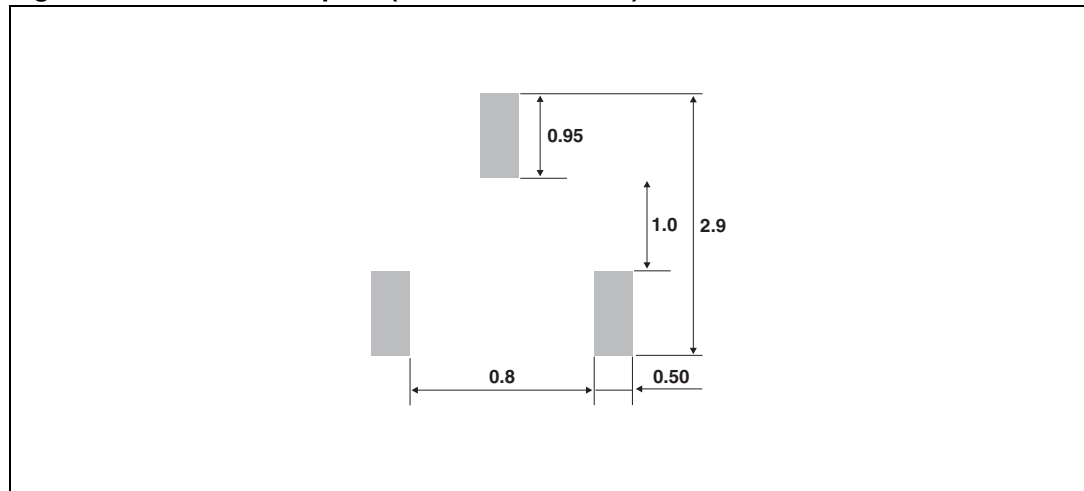
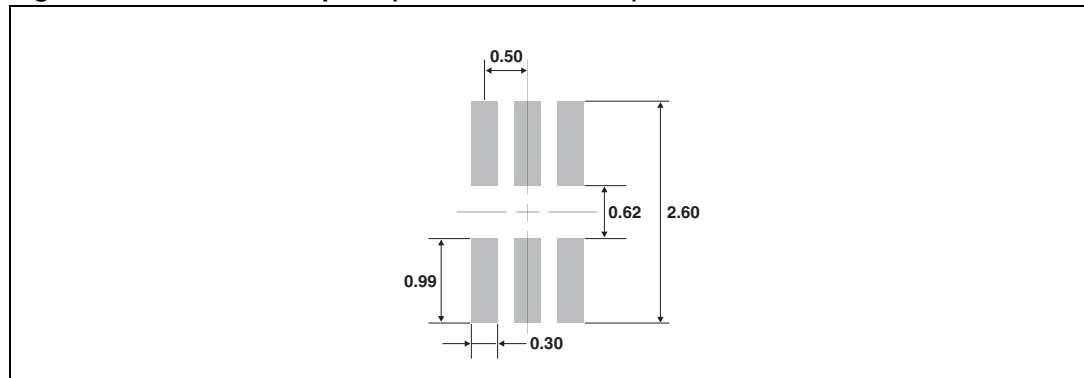

Table 8. SOT-666 dimensions

Ref.	Dimensions					
	Millimeters			Inches		
	Min.	Typ.	Max.	Min.	Typ.	Max.
A	0.45		0.60	0.018		0.024
A3	0.08		0.18	0.003		0.007
b	0.17		0.34	0.007		0.013
b1	0.19	0.27	0.34	0.007	0.011	0.013
D	1.50		1.70	0.059		0.067
E	1.50		1.70	0.059		0.067
E1	1.10		1.30	0.043		0.051
e		0.50			0.020	
L1		0.19			0.007	
L2	0.10		0.30	0.004		0.012
L3		0.10			0.004	

Figure 12. SOT-666 footprint (dimensions in mm)



4 Ordering information

Table 9. Ordering information

Order code	Marking	Package	Weight	Base qty	Delivery mode
BAS69WFILM	23	SOT-323 Single	6 mg	3000	Tape and reel
BAS69-04WFILM	24	SOT-323 Series	6 mg	3000	Tape and reel
BAS69-05WFILM	25	SOT-323 Common cathode	6 mg	3000	Tape and reel
BAS69-06WFILM	26	SOT-323 Common anode	6 mg	3000	Tape and reel
BAS69KFILM	65	SOD-523 Single	1.4 mg	3000	Tape and reel
BAS69-09P6FILM	69	SOT-666 Opposite	2.9 mg	3000	Tape and reel
BAS69-07P6FILM	67	SOT-666 Parallel	2.9 mg	3000	Tape and reel

5 Revision history

Table 10. Document revision history

Date	Revision	Changes
24-Jul-2006	1	First issue
12-Oct-2009	2	Updated Table 6 quote "L1" from 0.10 to 0.05.

Please Read Carefully:

Information in this document is provided solely in connection with ST products. STMicroelectronics NV and its subsidiaries ("ST") reserve the right to make changes, corrections, modifications or improvements, to this document, and the products and services described herein at any time, without notice.

All ST products are sold pursuant to ST's terms and conditions of sale.

Purchasers are solely responsible for the choice, selection and use of the ST products and services described herein, and ST assumes no liability whatsoever relating to the choice, selection or use of the ST products and services described herein.

No license, express or implied, by estoppel or otherwise, to any intellectual property rights is granted under this document. If any part of this document refers to any third party products or services it shall not be deemed a license grant by ST for the use of such third party products or services, or any intellectual property contained therein or considered as a warranty covering the use in any manner whatsoever of such third party products or services or any intellectual property contained therein.

UNLESS OTHERWISE SET FORTH IN ST'S TERMS AND CONDITIONS OF SALE ST DISCLAIMS ANY EXPRESS OR IMPLIED WARRANTY WITH RESPECT TO THE USE AND/OR SALE OF ST PRODUCTS INCLUDING WITHOUT LIMITATION IMPLIED WARRANTIES OF MERCHANTABILITY, FITNESS FOR A PARTICULAR PURPOSE (AND THEIR EQUIVALENTS UNDER THE LAWS OF ANY JURISDICTION), OR INFRINGEMENT OF ANY PATENT, COPYRIGHT OR OTHER INTELLECTUAL PROPERTY RIGHT.

UNLESS EXPRESSLY APPROVED IN WRITING BY AN AUTHORIZED ST REPRESENTATIVE, ST PRODUCTS ARE NOT RECOMMENDED, AUTHORIZED OR WARRANTED FOR USE IN MILITARY, AIR CRAFT, SPACE, LIFE SAVING, OR LIFE SUSTAINING APPLICATIONS, NOR IN PRODUCTS OR SYSTEMS WHERE FAILURE OR MALFUNCTION MAY RESULT IN PERSONAL INJURY, DEATH, OR SEVERE PROPERTY OR ENVIRONMENTAL DAMAGE. ST PRODUCTS WHICH ARE NOT SPECIFIED AS "AUTOMOTIVE GRADE" MAY ONLY BE USED IN AUTOMOTIVE APPLICATIONS AT USER'S OWN RISK.

Resale of ST products with provisions different from the statements and/or technical features set forth in this document shall immediately void any warranty granted by ST for the ST product or service described herein and shall not create or extend in any manner whatsoever, any liability of ST.

ST and the ST logo are trademarks or registered trademarks of ST in various countries.

Information in this document supersedes and replaces all information previously supplied.

The ST logo is a registered trademark of STMicroelectronics. All other names are the property of their respective owners.

© 2009 STMicroelectronics - All rights reserved



STMicroelectronics group of companies

Australia - Belgium - Brazil - Canada - China - Czech Republic - Finland - France - Germany - Hong Kong - India - Israel - Italy - Japan - Malaysia - Malta - Morocco - Philippines - Singapore - Spain - Sweden - Switzerland - United Kingdom - United States of America

www.st.com

Looking for pricing, stock, or lifecycle information?

Click below to explore more details on WIN SOURCE:

-  [View BAS69-07P6FILM on WIN SOURCE](#)
-  [STMicroelectronics Information](#)

Optimize Your Supply Chain with WIN SOURCE Solutions

-  Global Sourcing Solution
-  Obsolete Management
-  Cost Control Management
-  Shortage Management
-  Alternative Solution
-  Excess Inventory Management