



**THE DATASHEET OF
550MF155M520DGR**



VOLTAGE-CONTROLLED CRYSTAL OSCILLATOR (VCXO) 10 MHz TO 1.4 GHz

Features

- Available with any frequency from 10 to 945 MHz and select frequencies to 1.4 GHz
- 3rd generation DSPLL[®] with superior jitter performance (0.5 ps)
- 3x better temperature stability than SAW-based oscillators
- Excellent PSRR performance
- Internal fixed crystal frequency ensures high reliability and low aging
- Available CMOS, LVPECL, LVDS, and CML outputs
- 3.3, 2.5, and 1.8 V supply options
- Industry-standard 5 x 7 mm package and pinout
- Pb-free/RoHS-compliant

Applications

- SONET/SDH
- xDSL
- 10 GbE LAN/WAN
- Low-jitter clock generation
- Optical modules
- Clock and data recovery

Description

The Si550 VCXO utilizes Skyworks Solutions' advanced DSPLL[®] circuitry to provide a low-jitter clock at high frequencies. The Si550 supports any frequency from 10 to 945 MHz and select frequencies to 1417 MHz. Unlike traditional VCXOs, where a different crystal is required for each output frequency, the Si550 uses one fixed crystal to provide a wide range of output frequencies. This IC-based approach allows the crystal resonator to provide exceptional frequency stability and reliability. In addition, DSPLL clock synthesis provides superior supply noise rejection, simplifying the task of generating low-jitter clocks in noisy environments typically found in communication systems. The Si550 IC-based VCXO is factory-configurable for a wide variety of user specifications, including frequency, supply voltage, output format, tuning slope, and temperature stability. Specific configurations are factory programmed at time of shipment, thereby eliminating the long lead times associated with custom oscillators.

Functional Block Diagram

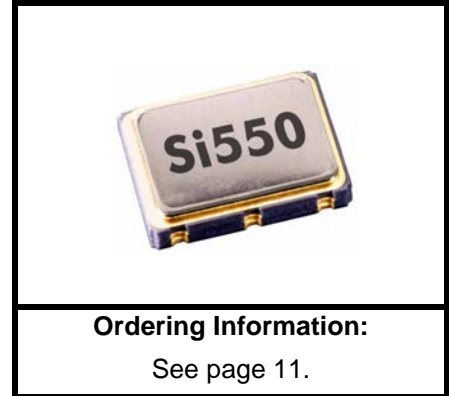
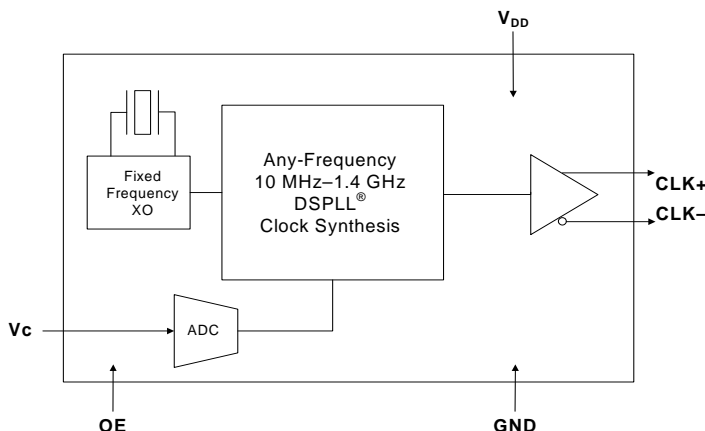

Ordering Information:

See page 11.

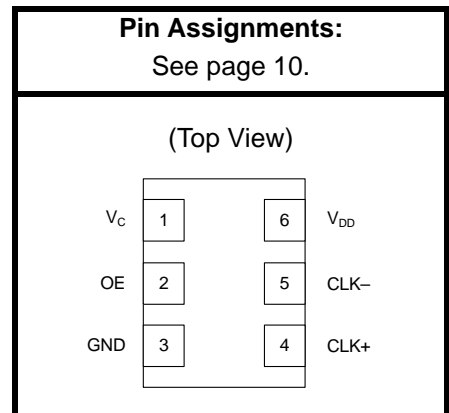

Si550

TABLE OF CONTENTS

- 1. Electrical Specifications3**
- 2. Pin Descriptions10**
- 3. Ordering Information11**
- 4. Package Outline and Suggested Pad Layout12**
- 5. 6-Pin PCB Land Pattern13**
- 6. Top Marking14**
 - 6.1. Si550 Top Marking14
 - 6.2. Top Marking Explanation14
- Document Change List15**
- Contact Information16**

1. Electrical Specifications

Table 1. Recommended Operating Conditions

| Parameter | Symbol | Test Condition | Min | Typ | Max | Units |
|---------------------------------|-----------------|-----------------|------------------------|-----|------|-------|
| Supply Voltage ¹ | V _{DD} | 3.3 V option | 2.97 | 3.3 | 3.63 | V |
| | | 2.5 V option | 2.25 | 2.5 | 2.75 | V |
| | | 1.8 V option | 1.71 | 1.8 | 1.89 | V |
| Supply Current | I _{DD} | Output enabled | | | | |
| | | LVPECL | — | 120 | 130 | mA |
| | | CML | — | 108 | 117 | |
| | | LVDS | — | 99 | 108 | |
| | | CMOS | — | 90 | 98 | |
| tristate mode | — | 60 | 75 | mA | | |
| Output Enable (OE) ² | | V _{IH} | 0.75 x V _{DD} | — | — | V |
| | | V _{IL} | — | — | 0.5 | V |
| Operating Temperature Range | T _A | | -40 | — | 85 | °C |

Notes:

- Selectable parameter specified by part number. See 3. "Ordering Information" on page 11 for further details.
- OE pin includes a 17 kΩ resistor to V_{DD}.

Table 2. V_C Control Voltage Input

| Parameter | Symbol | Test Condition | Min | Typ | Max | Units |
|---|-------------------|------------------------------|-----|--------------------|-----------------|-------|
| Control Voltage Tuning Slope ^{1,2,3} | K _V | 10 to 90% of V _{DD} | — | 33 | — | ppm/V |
| | | | — | 45 | — | |
| | | | — | 90 | — | |
| | | | — | 135 | — | |
| | | | — | 180 | — | |
| | | | — | 356 | — | |
| Control Voltage Linearity ⁴ | L _{VC} | BSL | -5 | ±1 | +5 | % |
| | | Incremental | -10 | ±5 | +10 | % |
| Modulation Bandwidth | BW | | 9.3 | 10.0 | 10.7 | kHz |
| V _C Input Impedance | Z _{VC} | | 500 | — | — | kΩ |
| Nominal Control Voltage | V _{CNOM} | @ f _O | — | V _{DD} /2 | — | V |
| Control Voltage Tuning Range | V _C | | 0 | | V _{DD} | V |

Notes:

- Positive slope; selectable option by part number. See 3. "Ordering Information" on page 11.
- For best jitter and phase noise performance, always choose the smallest K_V that meets the application's minimum APR requirements. See "AN266: VCXO Tuning Slope (K_V), Stability, and Absolute Pull Range (APR)" for more information.
- K_V variation is ±10% of typical values.
- BSL determined from deviation from best straight line fit with V_C ranging from 10 to 90% of V_{DD}. Incremental slope determined with V_C ranging from 10 to 90% of V_{DD}.

Table 3. CLK± Output Frequency Characteristics

| Parameter | Symbol | Test Condition | Min | Typ | Max | Units |
|--------------------------------------|------------------|------------------------------------|--------------------|-------------|--------------------|-------|
| Nominal Frequency ^{1,2,3} | f _O | LVDS/CML/LVPECL | 10 | — | 945 | MHz |
| | | CMOS | 10 | — | 160 | MHz |
| Temperature Stability ^{1,4} | | T _A = -40 to +85 °C | -20 -50 -100 | — — — | +20 +50 +100 | ppm |
| Absolute Pull Range ^{1,4} | APR | | ±12 | — | ±375 | ppm |
| Aging | | Frequency drift over first year. | — | — | ±3 | ppm |
| | | Frequency drift over 15 year life. | — | — | ±10 | |
| Power up Time ⁵ | t _{OSC} | | — | — | 10 | ms |

Notes:

1. See Section 3. "Ordering Information" on page 11 for further details.
2. Specified at time of order by part number. Also available in frequencies from 970 to 1134 MHz and 1213 to 1417 MHz.
3. Nominal output frequency set by V_{CNOM} = V_{DD}/2.
4. Selectable parameter specified by part number.
5. Time from power up or tristate mode to f_O.

Table 4. CLK± Output Levels and Symmetry

| Parameter | Symbol | Test Condition | Min | Typ | Max | Units |
|-----------------------------------|---------------------------------|---|------------------------|------------------------|------------------------|-----------------|
| LVPECL Output Option ¹ | V _O | mid-level | V _{DD} - 1.42 | — | V _{DD} - 1.25 | V |
| | V _{OD} | swing (diff) | 1.1 | — | 1.9 | V _{PP} |
| | V _{SE} | swing (single-ended) | 0.55 | — | 0.95 | V _{PP} |
| LVDS Output Option ² | V _O | mid-level | 1.125 | 1.20 | 1.275 | V |
| | V _{OD} | swing (diff) | 0.5 | 0.7 | 0.9 | V _{PP} |
| CML Output Option ² | V _O | 2.5/3.3 V option mid-level | — | V _{DD} - 1.30 | — | V |
| | | 1.8 V option mid-level | — | V _{DD} - 0.36 | — | V |
| | V _{OD} | 2.5/3.3 V option swing (diff) | 1.10 | 1.50 | 1.90 | V _{PP} |
| | | 1.8 V option swing (diff) | 0.35 | 0.425 | 0.50 | V _{PP} |
| CMOS Output Option ³ | V _{OH} | I _{OH} = 32 mA | 0.8 x V _{DD} | — | V _{DD} | V |
| | V _{OL} | I _{OL} = 32 mA | — | — | 0.4 | V |
| Rise/Fall time (20/80%) | t _R , t _F | LVPECL/LVDS/CML | — | — | 350 | ps |
| | | CMOS with C _L = 15 pF | — | 1 | — | ns |
| Symmetry (duty cycle) | SYM | LVPECL: V _{DD} - 1.3 V (diff) LVDS: 1.25 V (diff) CMOS: V _{DD} /2 | 45 | — | 55 | % |

Notes:

1. 50 Ω to V_{DD} - 2.0 V.
2. R_{term} = 100 Ω (differential).
3. C_L = 15 pF

Table 5. CLK± Output Phase Jitter

| Parameter | Symbol | Test Condition | Min | Typ | Max | Units | |
|---|----------|---------------------------|-----|------|-----|-------|--|
| Phase Jitter (RMS) ^{1,2,3} for $F_{OUT} \geq 500$ MHz | ϕ_J | $K_V = 33$ ppm/V | | | | | |
| | | 12 kHz to 20 MHz (OC-48) | — | 0.26 | — | ps | |
| | | 50 kHz to 80 MHz (OC-192) | — | 0.26 | — | | |
| | | $K_V = 45$ ppm/V | | | | | |
| | | 12 kHz to 20 MHz (OC-48) | — | 0.27 | — | ps | |
| | | 50 kHz to 80 MHz (OC-192) | — | 0.26 | — | | |
| | | $K_V = 90$ ppm/V | | | | | |
| | | 12 kHz to 20 MHz (OC-48) | — | 0.32 | — | ps | |
| | | 50 kHz to 80 MHz (OC-192) | — | 0.26 | — | | |
| | | $K_V = 135$ ppm/V | | | | | |
| | | 12 kHz to 20 MHz (OC-48) | — | 0.40 | — | ps | |
| | | 50 kHz to 80 MHz (OC-192) | — | 0.27 | — | | |
| $K_V = 180$ ppm/V | | | | | | | |
| 12 kHz to 20 MHz (OC-48) | — | 0.49 | — | ps | | | |
| 50 kHz to 80 MHz (OC-192) | — | 0.28 | — | | | | |
| $K_V = 356$ ppm/V | | | | | | | |
| 12 kHz to 20 MHz (OC-48) | — | 0.87 | — | ps | | | |
| 50 kHz to 80 MHz (OC-192) | — | 0.33 | — | | | | |

Notes:

1. Refer to AN255, AN256, and AN266 for further information.
2. For best jitter and phase noise performance, always choose the smallest K_V that meets the application's minimum APR requirements. See "AN266: VCXO Tuning Slope (K_V), Stability, and Absolute Pull Range (APR)" for more information.
3. See "AN255: Replacing 622 MHz VCXO devices with the Si550 VCXO" for comparison highlighting power supply rejection (PSR) advantage of Si55x versus SAW-based solutions.
4. Max jitter for LVPECL output with $V_C=1.65V$, $V_{DD}=3.3V$, 155.52 MHz.
5. Max offset frequencies: 80 MHz for $F_{OUT} \geq 250$ MHz, 20 MHz for $50 \text{ MHz} \leq F_{OUT} < 250$ MHz, 2 MHz for $10 \text{ MHz} \leq F_{OUT} < 50$ MHz.

Table 5. CLK± Output Phase Jitter (Continued)

| Parameter | Symbol | Test Condition | Min | Typ | Max | Units |
|---|----------------|---|--------|--------------|----------|-------|
| Phase Jitter (RMS) ^{1,2,3,4,5} for F _{OUT} of 125 to 500 MHz | ϕ _J | K _v = 33 ppm/V 12 kHz to 20 MHz (OC-48) 50 kHz to 80 MHz (OC-192) | — — | 0.37 0.33 | — — | ps |
| | | K _v = 45 ppm/V 12 kHz to 20 MHz (OC-48) 50 kHz to 80 MHz (OC-192) | — — | 0.37 0.33 | 0.4 — | ps |
| | | K _v = 90 ppm/V 12 kHz to 20 MHz (OC-48) 50 kHz to 80 MHz (OC-192) | — — | 0.43 0.34 | — — | ps |
| | | K _v = 135 ppm/V 12 kHz to 20 MHz (OC-48) 50 kHz to 80 MHz (OC-192) | — — | 0.50 0.34 | — — | ps |
| | | K _v = 180 ppm/V 12 kHz to 20 MHz (OC-48) 50 kHz to 80 MHz (OC-192) | — — | 0.59 0.35 | — — | ps |
| | | K _v = 356 ppm/V 12 kHz to 20 MHz (OC-48) 50 kHz to 80 MHz (OC-192) | — — | 1.00 0.39 | — — | ps |

Notes:

1. Refer to AN255, AN256, and AN266 for further information.
2. For best jitter and phase noise performance, always choose the smallest K_v that meets the application's minimum APR requirements. See "AN266: VCXO Tuning Slope (K_v), Stability, and Absolute Pull Range (APR)" for more information.
3. See "AN255: Replacing 622 MHz VCXO devices with the Si550 VCXO" for comparison highlighting power supply rejection (PSR) advantage of Si55x versus SAW-based solutions.
4. Max jitter for LVPECL output with V_C=1.65V, V_{DD}=3.3V, 155.52 MHz.
5. Max offset frequencies: 80 MHz for F_{OUT} ≥ 250 MHz, 20 MHz for 50 MHz ≤ F_{OUT} < 250 MHz, 2 MHz for 10 MHz ≤ F_{OUT} < 50 MHz.

Table 5. CLK± Output Phase Jitter (Continued)

| Parameter | Symbol | Test Condition | Min | Typ | Max | Units |
|---|----------|--|--------|--------------|--------|-------|
| Phase Jitter (RMS) ^{1,2,5} for F _{OUT} 10 to 160 MHz CMOS Output Only | ϕ_J | Kv = 33 ppm/V 12 kHz to 20 MHz (OC-48) 50 kHz to 20 MHz | — — | 0.63 0.62 | — — | ps |
| | | Kv = 45 ppm/V 12 kHz to 20 MHz (OC-48) 50 kHz to 20 MHz | — — | 0.63 0.62 | — — | ps |
| | | Kv = 90 ppm/V 12 kHz to 20 MHz (OC-48) 50 kHz to 20 MHz | — — | 0.67 0.66 | — — | ps |
| | | Kv = 135 ppm/V 12 kHz to 20 MHz (OC-48) 50 kHz to 20 MHz | — — | 0.74 0.72 | — — | ps |
| | | Kv = 180 ppm/V 12 kHz to 20 MHz (OC-48) 50 kHz to 20 MHz | — — | 0.83 0.8 | — — | ps |
| | | Kv = 356 ppm/V 12 kHz to 20 MHz (OC-48) 50 kHz to 20 MHz | — — | 1.26 1.2 | — — | ps |

Notes:

1. Refer to AN255, AN256, and AN266 for further information.
2. For best jitter and phase noise performance, always choose the smallest K_V that meets the application's minimum APR requirements. See "AN266: VCXO Tuning Slope (K_V), Stability, and Absolute Pull Range (APR)" for more information.
3. See "AN255: Replacing 622 MHz VCXO devices with the Si550 VCXO" for comparison highlighting power supply rejection (PSR) advantage of Si55x versus SAW-based solutions.
4. Max jitter for LVPECL output with V_C=1.65V, V_{DD}=3.3V, 155.52 MHz.
5. Max offset frequencies: 80 MHz for F_{OUT} ≥ 250 MHz, 20 MHz for 50 MHz ≤ F_{OUT} < 250 MHz, 2 MHz for 10 MHz ≤ F_{OUT} < 50 MHz.

Table 6. CLK± Output Period Jitter

| Parameter | Symbol | Test Condition | Min | Typ | Max | Units |
|----------------|------------------|----------------|-----|-----|-----|-------|
| Period Jitter* | J _{PER} | RMS | — | 2 | — | ps |
| | | Peak-to-Peak | — | 14 | — | |

***Note:** Any output mode, including CMOS, LVPECL, LVDS, CML. N = 1000 cycles. Refer to AN279 for further information.

Table 7. CLK± Output Phase Noise (Typical)

| Offset Frequency | 74.25 MHz 90 ppm/V LVPECL | 155.52 MHz 45 ppm/V LVPECL | 491.52 MHz 45 ppm/V LVPECL | 622.08 MHz 135 ppm/V LVPECL | Units |
|------------------|---------------------------------|----------------------------------|----------------------------------|-----------------------------------|--------|
| 100 Hz | -87 | -86 | -75 | -65 | dBc/Hz |
| 1 kHz | -114 | -111 | -100 | -90 | |
| 10 kHz | -132 | -128 | -116 | -109 | |
| 100 kHz | -142 | -133 | -124 | -121 | |
| 1 MHz | -148 | -144 | -135 | -134 | |
| 10 MHz | -150 | -147 | -146 | -146 | |
| 100 MHz | n/a | n/a | -147 | -147 | |

Table 8. Environmental Compliance

The Si550 meets the following qualification test requirements.

| Parameter | Conditions/Test Method |
|----------------------------|--------------------------|
| Mechanical Shock | MIL-STD-883, Method 2002 |
| Mechanical Vibration | MIL-STD-883, Method 2007 |
| Solderability | MIL-STD-883, Method 203 |
| Gross & Fine Leak | MIL-STD-883, Method 1014 |
| Resistance to Solder Heat | MIL-STD-883, Method 2036 |
| Moisture Sensitivity Level | J-STD-020, MSL 1 |
| Contact Pads | J-STD-020, MSL 1 |

Table 9. Thermal Characteristics

(Typical values TA = 25 °C, VDD = 3.3 V)

| Parameter | Symbol | Test Condition | Min | Typ | Max | Unit |
|--|---------------|----------------|-----|------|-----|------|
| Thermal Resistance Junction to Ambient | θ_{JA} | Still Air | — | 84.6 | — | °C/W |
| Thermal Resistance Junction to Case | θ_{JC} | Still Air | — | 38.8 | — | °C/W |
| Ambient Temperature | T_A | | -40 | — | 85 | °C |
| Junction Temperature | T_J | | — | — | 125 | °C |

Table 10. Absolute Maximum Ratings¹

| Parameter | Symbol | Rating | Units |
|--|------------|------------------------|---------|
| Maximum Operating Temperature | T_{AMAX} | 85 | °C |
| Supply Voltage, 1.8 V Option | V_{DD} | -0.5 to +1.9 | V |
| Supply Voltage, 2.5/3.3 V Option | V_{DD} | -0.5 to +3.8 | V |
| Input Voltage | V_I | -0.5 to $V_{DD} + 0.3$ | V |
| Storage Temperature | T_S | -55 to +125 | °C |
| ESD Sensitivity (HBM, per JESD22-A114) | ESD | 2500 | V |
| Soldering Temperature (Pb-free profile) ² | T_{PEAK} | 260 | °C |
| Soldering Temperature Time @ T_{PEAK} (Pb-free profile) ² | t_P | 20–40 | seconds |

Notes:

1. Stresses beyond those listed in Absolute Maximum Ratings may cause permanent damage to the device. Functional operation or specification compliance is not implied at these conditions. Exposure to maximum rating conditions for extended periods may affect device reliability.
2. The device is compliant with JEDEC J-STD-020C. Refer to Si5xx Packaging FAQ at https://www.skyworksinc.com/Product_Certificate.aspx for further information, including soldering profiles.

Si550

2. Pin Descriptions

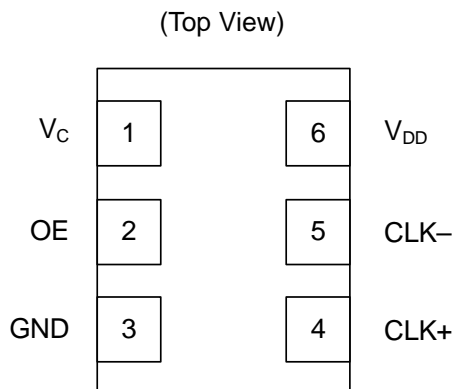

Table 11. Si550 Pin Descriptions

| Pin | Name | Type | Function |
|-----|------------------------|--------------|---|
| 1 | V_C | Analog Input | Control Voltage |
| 2 | OE* | Input | Output Enable (Polarity = High): 0 = clock output disabled (outputs tri-stated) 1 = clock output enabled Output Enable (Polarity = Low): 0 = clock output enabled 1 = clock output disabled (outputs tri-stated) |
| 3 | GND | Ground | Electrical and Case Ground |
| 4 | CLK+ | Output | Oscillator Output |
| 5 | CLK- (N/A for CMOS) | Output | Complementary Output (N/C for CMOS, make no external connection) |
| 6 | V_{DD} | Power | Power Supply Voltage |

***Note:** OE includes 17 k Ω pullup resistor to V_{DD} . See Section 3. "Ordering Information" on page 11 for details on OE polarity ordering options.

3. Ordering Information

The Si550 supports a variety of options including frequency, temperature stability, tuning slope, output format, and V_{DD} . Specific device configurations are programmed into the Si550 at time of shipment. Configurations are specified using the Part Number Configuration chart shown below. Skyworks Solutions provides a web browser-based part number configuration utility to simplify this process. Refer to <https://www.skyworksinc.com/en/Products/Timing> to access this tool and for further ordering instructions. The Si550 VCXO series is available in an industry-standard, RoHS compliant, lead-free, 6-pad, 5 x 7 mm package. Tape and reel packaging is an ordering option.

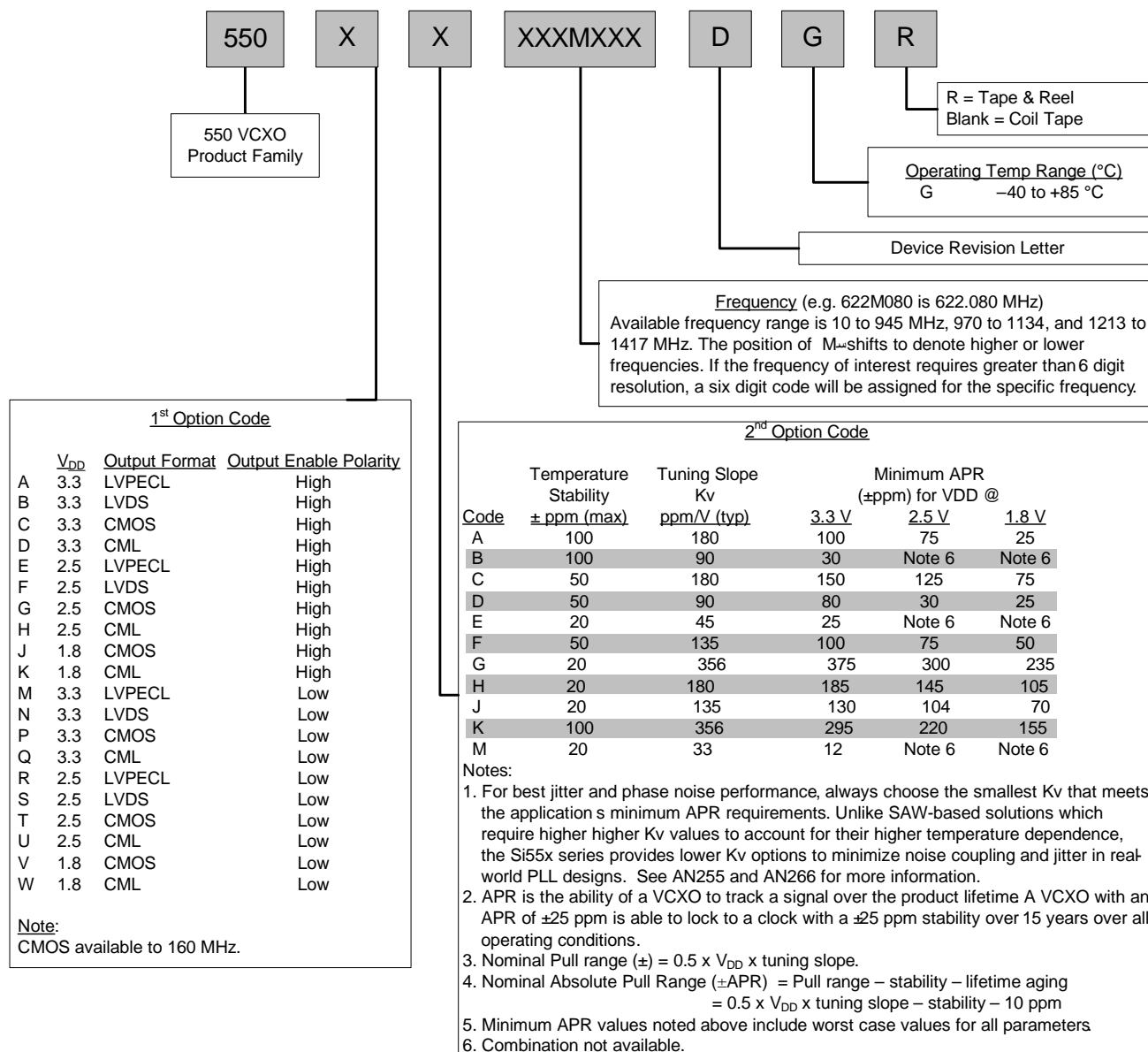

Example Part Number: 550AF622M080DGR is a 5 x 7 mm VCXO in a 6 pad package. The nominal frequency is 622.080 MHz, with a 3.3 V supply, LVPECL output, and Output Enable active high polarity. Temperature stability is specified as ± 50 ppm and the tuning slope is 135 ppm/V. The part is specified for a -40 to $+85$ $^{\circ}$ C ambient temperature range operation and is shipped in tape and reel format.

Figure 1. Part Number Convention

4. Package Outline and Suggested Pad Layout

Figure 2 illustrates the package details for the Si550. Table 12 lists the values for the dimensions shown in the illustration.

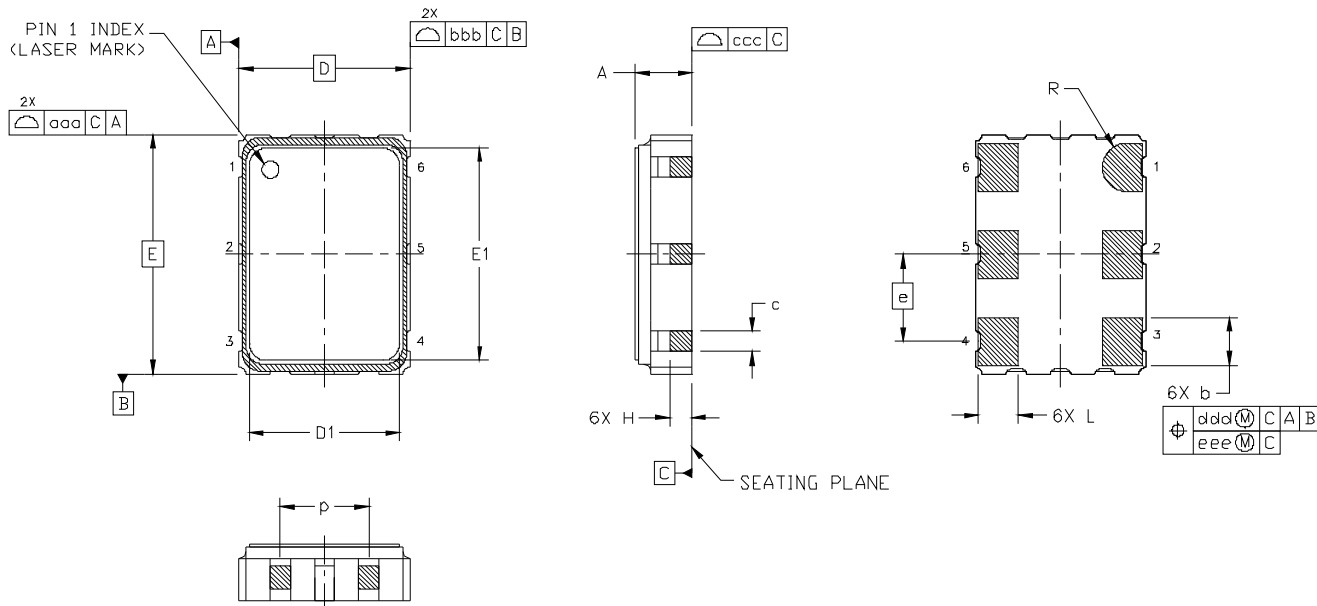

Figure 2. Si550 Outline Diagram

Table 12. Package Diagram Dimensions (mm)

| Dimension | Min | Nom | Max |
|-----------|-----------|------|------|
| A | 1.50 | 1.65 | 1.80 |
| b | 1.30 | 1.40 | 1.50 |
| c | 0.50 | 0.60 | 0.70 |
| D | 5.00 BSC | | |
| D1 | 4.30 | 4.40 | 4.50 |
| e | 2.54 BSC. | | |
| E | 7.00 BSC. | | |
| E1 | 6.10 | 6.20 | 6.30 |
| H | 0.55 | 0.65 | 0.75 |
| L | 1.17 | 1.27 | 1.37 |
| p | 1.80 | — | 2.60 |
| R | 0.70 REF | | |
| aaa | 0.15 | | |
| bbb | 0.15 | | |
| ccc | 0.10 | | |
| ddd | 0.10 | | |
| eee | 0.50 | | |

5. 6-Pin PCB Land Pattern

Figure 3 illustrates the 6-pin PCB land pattern for the Si550. Table 13 lists the values for the dimensions shown in the illustration.

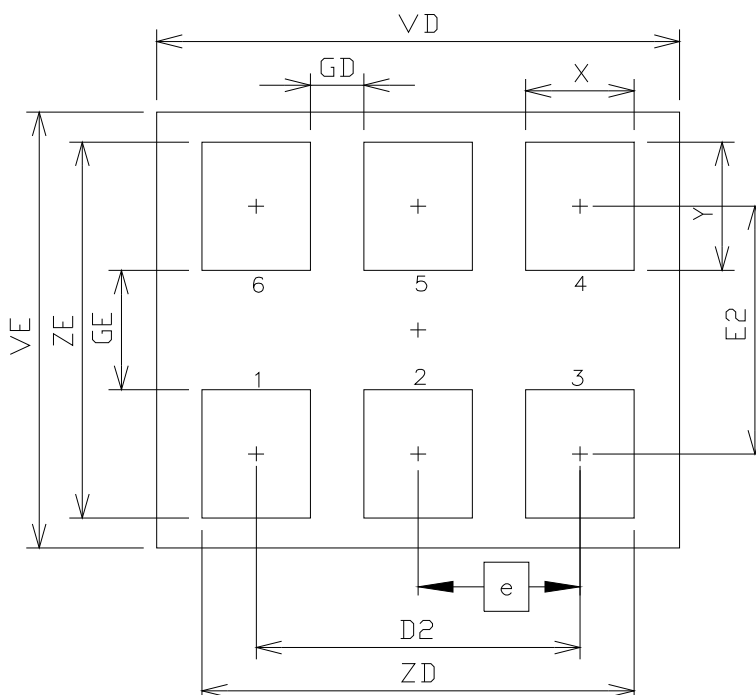

Figure 3. Si550 PCB Land Pattern

Table 13. PCB Land Pattern Dimensions (mm)

| Dimension | Min | Max |
|-----------|------|----------|
| D2 | | 5.08 REF |
| e | | 2.54 BSC |
| E2 | | 4.15 REF |
| GD | 0.84 | — |
| GE | 2.00 | — |
| VD | | 8.20 REF |
| VE | | 7.30 REF |
| X | | 1.70 TYP |
| Y | | 2.15 REF |
| ZD | — | 6.78 |
| ZE | — | 6.30 |

Notes:

1. Dimensioning and tolerancing per the ANSI Y14.5M-1994 specification.
2. Land pattern design based on IPC-7351 guidelines.
3. All dimensions shown are at maximum material condition (MMC).
4. Controlling dimension is in millimeters (mm).

Si550

6. Top Marking

6.1. Si550 Top Marking

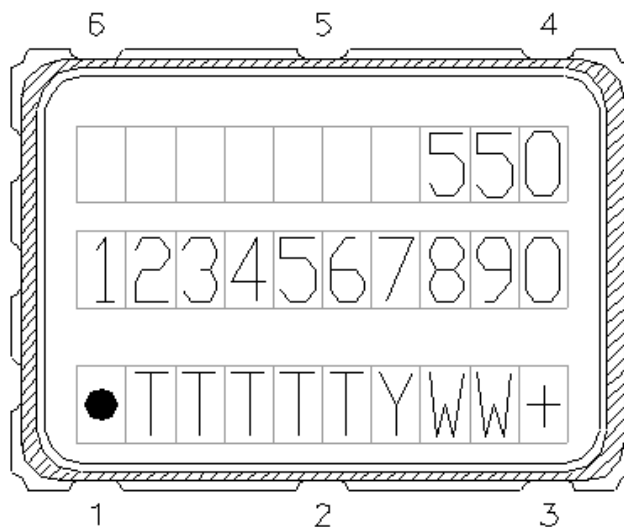

6.2. Top Marking Explanation

| Line | Position | Description |
|------|-------------------|---|
| 1 | 1–10 | "Part Family Number, 550 (First 3 characters in part number) |
| 2 | 1–10 | Si550: Option1+Option2+Freq(6007)+Temp |
| 3 | Trace Code | |
| | Position 1 | Pin 1 orientation mark (dot) |
| | Position 2 | Product Revision (D) |
| | Position 3–6 | Tiny Trace Code (4 alphanumeric characters per assembly release instructions) |
| | Position 7 | Year (least significant year digit), to be assigned by assembly site (ex: 2010 = 0) |
| | Position 8–9 | Calendar Work Week number (1–53), to be assigned by assembly site |
| | Position 10 | "+" to indicate Pb-Free and RoHS-compliant |

DOCUMENT CHANGE LIST

Revision 0.6 to Revision 1.0

- Updated Table 4 on page 4.
 - Updated 2.5 V/3.3 V and 1.8 V CML output level specifications.
- Updated Table 5 on page 5.
 - Removed the words “Differential Modes: LVPECL/LVDS/CML” in the footnote referring to AN256.
 - Added footnotes clarifying max offset frequency test conditions.
 - Added CMOS phase jitter specs.
- Updated Table 10 on page 9.
 - Separated 1.8 V, 2.5 V/3.3 V supply voltage specifications.
- Updated and clarified Table 8 on page 8
 - Added “Moisture Sensitivity Level” and “Contact Pads” rows.
- Updated 6. “Top Marking” on page 14 to reflect specific marking information (previously, figure was generic).
- Updated 4. “Package Outline and Suggested Pad Layout” on page 12.
 - Added crystal impedance pin in Figure 2 on page 12 and Table 12 on page 12.
- Reordered spec tables and back matter to conform to data sheet quality conventions.

Revision 1.0 to Revision 1.1

- Added Table 9, “Thermal Characteristics,” on page 8.

Revision 1.1 to Revision 1.2

June, 2018

- Changed “Trays” to “Coil Tape” in section 3. “Ordering Information”.



ClockBuilder Pro

One-click access to Timing tools, documentation, software, source code libraries & more. Available for Windows and iOS (CBGo only).

skyworksinc.com/CBPro



Portfolio

skyworksinc.com



SW/HW

skyworksinc.com/CBPro

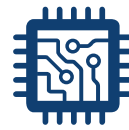

Quality

skyworksinc.com/quality



Support & Resources

skyworksinc.com/support

Copyright © 2022 Skyworks Solutions, Inc. All Rights Reserved.

Information in this document is provided in connection with Skyworks Solutions, Inc. ("Skyworks") products or services. These materials, including the information contained herein, are provided by Skyworks as a service to its customers and may be used for informational purposes only by the customer. Skyworks assumes no responsibility for errors or omissions in these materials or the information contained herein. Skyworks may change its documentation, products, services, specifications or product descriptions at any time, without notice. Skyworks makes no commitment to update the materials or information and shall have no responsibility whatsoever for conflicts, incompatibilities, or other difficulties arising from any future changes.

No license, whether express, implied, by estoppel or otherwise, is granted to any intellectual property rights by this document. Skyworks assumes no liability for any materials, products or information provided hereunder, including the sale, distribution, reproduction or use of Skyworks products, information or materials, except as may be provided in Skyworks' Terms and Conditions of Sale.

THE MATERIALS, PRODUCTS AND INFORMATION ARE PROVIDED "AS IS" WITHOUT WARRANTY OF ANY KIND, WHETHER EXPRESS, IMPLIED, STATUTORY, OR OTHERWISE, INCLUDING FITNESS FOR A PARTICULAR PURPOSE OR USE, MERCHANTABILITY, PERFORMANCE, QUALITY OR NON-INFRINGEMENT OF ANY INTELLECTUAL PROPERTY RIGHT; ALL SUCH WARRANTIES ARE HEREBY EXPRESSLY DISCLAIMED. SKYWORKS DOES NOT WARRANT THE ACCURACY OR COMPLETENESS OF THE INFORMATION, TEXT, GRAPHICS OR OTHER ITEMS CONTAINED WITHIN THESE MATERIALS. SKYWORKS SHALL NOT BE LIABLE FOR ANY DAMAGES, INCLUDING BUT NOT LIMITED TO ANY SPECIAL, INDIRECT, INCIDENTAL, STATUTORY, OR CONSEQUENTIAL DAMAGES, INCLUDING WITHOUT LIMITATION, LOST REVENUES OR LOST PROFITS THAT MAY RESULT FROM THE USE OF THE MATERIALS OR INFORMATION, WHETHER OR NOT THE RECIPIENT OF MATERIALS HAS BEEN ADVISED OF THE POSSIBILITY OF SUCH DAMAGE

Skyworks products are not intended for use in medical, lifesaving or life-sustaining applications, or other equipment in which the failure of the Skyworks products could lead to personal injury, death, physical or environmental damage. Skyworks customers using or selling Skyworks products for use in such applications do so at their own risk and agree to fully indemnify Skyworks for any damages resulting from such improper use or sale.

Customers are responsible for their products and applications using Skyworks products, which may deviate from published specifications as a result of design defects, errors, or operation of products outside of published parameters or design specifications. Customers should include design and operating safeguards to minimize these and other risks. Skyworks assumes no liability for applications assistance, customer product design, or damage to any equipment resulting from the use of Skyworks products outside of Skyworks' published specifications or parameters.

Skyworks, the Skyworks symbol, Sky5®, SkyOne®, SkyBlue™, Skyworks Green™, Clockbuilder®, DSPLL®, ISOMODEM®, ProSLIC®, and SiPHY® are trademarks or registered trademarks of Skyworks Solutions, Inc. or its subsidiaries in the United States and other countries. Third-party brands and names are for identification purposes only and are the property of their respective owners. Additional information, including relevant terms and conditions, posted at www.skyworksinc.com, are incorporated by reference.

Skyworks Solutions, Inc. | Nasdaq: SWKS | sales@skyworksinc.com | www.skyworksinc.com

USA: 781-376-3000 | Asia: 886-2-2735 0399 | Europe: 33 (0)1 43548540

Looking for pricing, stock, or lifecycle information?

Click below to explore more details on WIN SOURCE:

 [View 550MF155M520DGR on WIN SOURCE](#)

 [Skyworks Solutions Inc. Information](#)

Optimize Your Supply Chain with WIN SOURCE Solutions

-  Global Sourcing Solution
-  Obsolete Management
-  Cost Control Management
-  Shortage Management
-  Alternative Solution
-  Excess Inventory Management