



**THE DATASHEET OF  
550BF156M280DG**



# VOLTAGE-CONTROLLED CRYSTAL OSCILLATOR (VCXO) 10 MHz TO 1.4 GHz

## Features

- Available with any frequency from 10 to 945 MHz and select frequencies to 1.4 GHz
- 3rd generation DSPLL<sup>®</sup> with superior jitter performance (0.5 ps)
- 3x better temperature stability than SAW-based oscillators
- Excellent PSRR performance
- Internal fixed crystal frequency ensures high reliability and low aging
- Available CMOS, LVPECL, LVDS, and CML outputs
- 3.3, 2.5, and 1.8 V supply options
- Industry-standard 5 x 7 mm package and pinout
- Pb-free/RoHS-compliant

## Applications

- SONET/SDH
- xDSL
- 10 GbE LAN/WAN
- Low-jitter clock generation
- Optical modules
- Clock and data recovery

## Description

The Si550 VCXO utilizes Skyworks Solutions' advanced DSPLL<sup>®</sup> circuitry to provide a low-jitter clock at high frequencies. The Si550 supports any frequency from 10 to 945 MHz and select frequencies to 1417 MHz. Unlike traditional VCXOs, where a different crystal is required for each output frequency, the Si550 uses one fixed crystal to provide a wide range of output frequencies. This IC-based approach allows the crystal resonator to provide exceptional frequency stability and reliability. In addition, DSPLL clock synthesis provides superior supply noise rejection, simplifying the task of generating low-jitter clocks in noisy environments typically found in communication systems. The Si550 IC-based VCXO is factory-configurable for a wide variety of user specifications, including frequency, supply voltage, output format, tuning slope, and temperature stability. Specific configurations are factory programmed at time of shipment, thereby eliminating the long lead times associated with custom oscillators.

## Functional Block Diagram

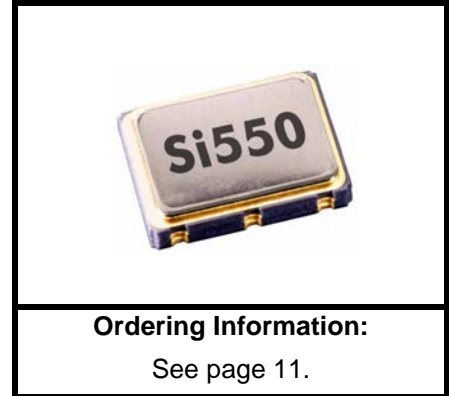
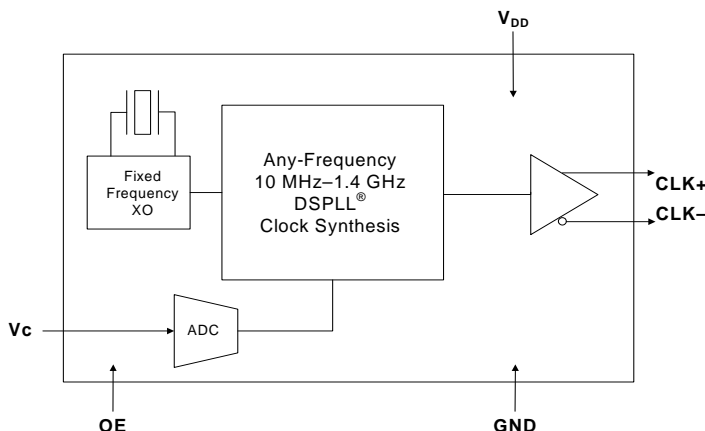

### Ordering Information:

See page 11.

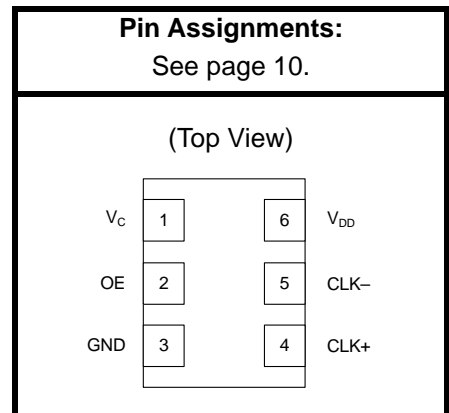

# Si550

---

## TABLE OF CONTENTS

---

<b>1. Electrical Specifications</b>	<b>3</b>
<b>2. Pin Descriptions</b>	<b>10</b>
<b>3. Ordering Information</b>	<b>11</b>
<b>4. Package Outline and Suggested Pad Layout</b>	<b>12</b>
<b>5. 6-Pin PCB Land Pattern</b>	<b>13</b>
<b>6. Top Marking</b>	<b>14</b>
6.1. Si550 Top Marking	14
6.2. Top Marking Explanation	14
<b>Document Change List</b>	<b>15</b>
<b>Contact Information</b>	<b>16</b>

## 1. Electrical Specifications

**Table 1. Recommended Operating Conditions**

Parameter	Symbol	Test Condition	Min	Typ	Max	Units
Supply Voltage <sup>1</sup>	V <sub>DD</sub>	3.3 V option	2.97	3.3	3.63	V
		2.5 V option	2.25	2.5	2.75	V
		1.8 V option	1.71	1.8	1.89	V
Supply Current	I <sub>DD</sub>	Output enabled				
		LVPECL	—	120	130	mA
		CML	—	108	117	
		LVDS	—	99	108	
		CMOS	—	90	98	
tristate mode	—	60	75	mA		
Output Enable (OE) <sup>2</sup>		V <sub>IH</sub>	0.75 x V <sub>DD</sub>	—	—	V
		V <sub>IL</sub>	—	—	0.5	V
Operating Temperature Range	T <sub>A</sub>		-40	—	85	°C

**Notes:**

- Selectable parameter specified by part number. See 3. "Ordering Information" on page 11 for further details.
- OE pin includes a 17 kΩ resistor to V<sub>DD</sub>.

**Table 2. V<sub>C</sub> Control Voltage Input**

Parameter	Symbol	Test Condition	Min	Typ	Max	Units
Control Voltage Tuning Slope <sup>1,2,3</sup>	K <sub>V</sub>	10 to 90% of V <sub>DD</sub>	—	33	—	ppm/V
			—	45	—	
			—	90	—	
			—	135	—	
			—	180	—	
			—	356	—	
Control Voltage Linearity <sup>4</sup>	L <sub>VC</sub>	BSL	-5	±1	+5	%
		Incremental	-10	±5	+10	%
Modulation Bandwidth	BW		9.3	10.0	10.7	kHz
V <sub>C</sub> Input Impedance	Z <sub>VC</sub>		500	—	—	kΩ
Nominal Control Voltage	V <sub>CNOM</sub>	@ f <sub>O</sub>	—	V <sub>DD</sub> /2	—	V
Control Voltage Tuning Range	V <sub>C</sub>		0		V <sub>DD</sub>	V

**Notes:**

- Positive slope; selectable option by part number. See 3. "Ordering Information" on page 11.
- For best jitter and phase noise performance, always choose the smallest K<sub>V</sub> that meets the application's minimum APR requirements. See "AN266: VCXO Tuning Slope (K<sub>V</sub>), Stability, and Absolute Pull Range (APR)" for more information.
- K<sub>V</sub> variation is ±10% of typical values.
- BSL determined from deviation from best straight line fit with V<sub>C</sub> ranging from 10 to 90% of V<sub>DD</sub>. Incremental slope determined with V<sub>C</sub> ranging from 10 to 90% of V<sub>DD</sub>.

**Table 3. CLK± Output Frequency Characteristics**

Parameter	Symbol	Test Condition	Min	Typ	Max	Units
Nominal Frequency <sup>1,2,3</sup>	f <sub>O</sub>	LVDS/CML/LVPECL	10	—	945	MHz
		CMOS	10	—	160	MHz
Temperature Stability <sup>1,4</sup>		T <sub>A</sub> = -40 to +85 °C	-20 -50 -100	— — —	+20 +50 +100	ppm
Absolute Pull Range <sup>1,4</sup>	APR		±12	—	±375	ppm
Aging		Frequency drift over first year.	—	—	±3	ppm
		Frequency drift over 15 year life.	—	—	±10	
Power up Time <sup>5</sup>	t <sub>OSC</sub>		—	—	10	ms

**Notes:**

1. See Section 3. "Ordering Information" on page 11 for further details.
2. Specified at time of order by part number. Also available in frequencies from 970 to 1134 MHz and 1213 to 1417 MHz.
3. Nominal output frequency set by V<sub>CNOM</sub> = V<sub>DD</sub>/2.
4. Selectable parameter specified by part number.
5. Time from power up or tristate mode to f<sub>O</sub>.

**Table 4. CLK± Output Levels and Symmetry**

Parameter	Symbol	Test Condition	Min	Typ	Max	Units
LVPECL Output Option <sup>1</sup>	V <sub>O</sub>	mid-level	V <sub>DD</sub> - 1.42	—	V <sub>DD</sub> - 1.25	V
	V <sub>OD</sub>	swing (diff)	1.1	—	1.9	V <sub>PP</sub>
	V <sub>SE</sub>	swing (single-ended)	0.55	—	0.95	V <sub>PP</sub>
LVDS Output Option <sup>2</sup>	V <sub>O</sub>	mid-level	1.125	1.20	1.275	V
	V <sub>OD</sub>	swing (diff)	0.5	0.7	0.9	V <sub>PP</sub>
CML Output Option <sup>2</sup>	V <sub>O</sub>	2.5/3.3 V option mid-level	—	V <sub>DD</sub> - 1.30	—	V
		1.8 V option mid-level	—	V <sub>DD</sub> - 0.36	—	V
	V <sub>OD</sub>	2.5/3.3 V option swing (diff)	1.10	1.50	1.90	V <sub>PP</sub>
		1.8 V option swing (diff)	0.35	0.425	0.50	V <sub>PP</sub>
CMOS Output Option <sup>3</sup>	V <sub>OH</sub>	I <sub>OH</sub> = 32 mA	0.8 x V <sub>DD</sub>	—	V <sub>DD</sub>	V
	V <sub>OL</sub>	I <sub>OL</sub> = 32 mA	—	—	0.4	V
Rise/Fall time (20/80%)	t <sub>R</sub> , t <sub>F</sub>	LVPECL/LVDS/CML	—	—	350	ps
		CMOS with C <sub>L</sub> = 15 pF	—	1	—	ns
Symmetry (duty cycle)	SYM	LVPECL: V <sub>DD</sub> - 1.3 V (diff) LVDS: 1.25 V (diff) CMOS: V <sub>DD</sub> /2	45	—	55	%

**Notes:**

1. 50 Ω to V<sub>DD</sub> - 2.0 V.
2. R<sub>term</sub> = 100 Ω (differential).
3. C<sub>L</sub> = 15 pF

Table 5. CLK± Output Phase Jitter

Parameter	Symbol	Test Condition	Min	Typ	Max	Units
Phase Jitter (RMS) <sup>1,2,3</sup> for $F_{OUT} \geq 500$ MHz	$\phi_J$	$K_V = 33$ ppm/V 12 kHz to 20 MHz (OC-48) 50 kHz to 80 MHz (OC-192)	— —	0.26 0.26	— —	ps
		$K_V = 45$ ppm/V 12 kHz to 20 MHz (OC-48) 50 kHz to 80 MHz (OC-192)	— —	0.27 0.26	— —	ps
		$K_V = 90$ ppm/V 12 kHz to 20 MHz (OC-48) 50 kHz to 80 MHz (OC-192)	— —	0.32 0.26	— —	ps
		$K_V = 135$ ppm/V 12 kHz to 20 MHz (OC-48) 50 kHz to 80 MHz (OC-192)	— —	0.40 0.27	— —	ps
		$K_V = 180$ ppm/V 12 kHz to 20 MHz (OC-48) 50 kHz to 80 MHz (OC-192)	— —	0.49 0.28	— —	ps
		$K_V = 356$ ppm/V 12 kHz to 20 MHz (OC-48) 50 kHz to 80 MHz (OC-192)	— —	0.87 0.33	— —	ps

**Notes:**

1. Refer to AN255, AN256, and AN266 for further information.
2. For best jitter and phase noise performance, always choose the smallest  $K_V$  that meets the application's minimum APR requirements. See "AN266: VCXO Tuning Slope ( $K_V$ ), Stability, and Absolute Pull Range (APR)" for more information.
3. See "AN255: Replacing 622 MHz VCXO devices with the Si550 VCXO" for comparison highlighting power supply rejection (PSR) advantage of Si55x versus SAW-based solutions.
4. Max jitter for LVPECL output with  $V_C=1.65V$ ,  $V_{DD}=3.3V$ , 155.52 MHz.
5. Max offset frequencies: 80 MHz for  $F_{OUT} \geq 250$  MHz, 20 MHz for  $50 \text{ MHz} \leq F_{OUT} < 250$  MHz, 2 MHz for  $10 \text{ MHz} \leq F_{OUT} < 50$  MHz.

**Table 5. CLK± Output Phase Jitter (Continued)**

Parameter	Symbol	Test Condition	Min	Typ	Max	Units
Phase Jitter (RMS) <sup>1,2,3,4,5</sup> for F <sub>OUT</sub> of 125 to 500 MHz	$\phi_J$	Kv = 33 ppm/V 12 kHz to 20 MHz (OC-48) 50 kHz to 80 MHz (OC-192)	— —	0.37 0.33	— —	ps
		Kv = 45 ppm/V 12 kHz to 20 MHz (OC-48) 50 kHz to 80 MHz (OC-192)	— —	0.37 0.33	0.4 —	ps
		Kv = 90 ppm/V 12 kHz to 20 MHz (OC-48) 50 kHz to 80 MHz (OC-192)	— —	0.43 0.34	— —	ps
		Kv = 135 ppm/V 12 kHz to 20 MHz (OC-48) 50 kHz to 80 MHz (OC-192)	— —	0.50 0.34	— —	ps
		Kv = 180 ppm/V 12 kHz to 20 MHz (OC-48) 50 kHz to 80 MHz (OC-192)	— —	0.59 0.35	— —	ps
		Kv = 356 ppm/V 12 kHz to 20 MHz (OC-48) 50 kHz to 80 MHz (OC-192)	— —	1.00 0.39	— —	ps

**Notes:**

1. Refer to AN255, AN256, and AN266 for further information.
2. For best jitter and phase noise performance, always choose the smallest K<sub>V</sub> that meets the application's minimum APR requirements. See "AN266: VCXO Tuning Slope (K<sub>V</sub>), Stability, and Absolute Pull Range (APR)" for more information.
3. See "AN255: Replacing 622 MHz VCXO devices with the Si550 VCXO" for comparison highlighting power supply rejection (PSR) advantage of Si55x versus SAW-based solutions.
4. Max jitter for LVPECL output with V<sub>C</sub>=1.65V, V<sub>DD</sub>=3.3V, 155.52 MHz.
5. Max offset frequencies: 80 MHz for F<sub>OUT</sub> ≥ 250 MHz, 20 MHz for 50 MHz ≤ F<sub>OUT</sub> < 250 MHz, 2 MHz for 10 MHz ≤ F<sub>OUT</sub> < 50 MHz.

Table 5. CLK± Output Phase Jitter (Continued)

Parameter	Symbol	Test Condition	Min	Typ	Max	Units
Phase Jitter (RMS) <sup>1,2,5</sup> for F <sub>OUT</sub> 10 to 160 MHz CMOS Output Only	$\phi_J$	Kv = 33 ppm/V 12 kHz to 20 MHz (OC-48) 50 kHz to 20 MHz	— —	0.63 0.62	— —	ps
		Kv = 45 ppm/V 12 kHz to 20 MHz (OC-48) 50 kHz to 20 MHz	— —	0.63 0.62	— —	ps
		Kv = 90 ppm/V 12 kHz to 20 MHz (OC-48) 50 kHz to 20 MHz	— —	0.67 0.66	— —	ps
		Kv = 135 ppm/V 12 kHz to 20 MHz (OC-48) 50 kHz to 20 MHz	— —	0.74 0.72	— —	ps
		Kv = 180 ppm/V 12 kHz to 20 MHz (OC-48) 50 kHz to 20 MHz	— —	0.83 0.8	— —	ps
		Kv = 356 ppm/V 12 kHz to 20 MHz (OC-48) 50 kHz to 20 MHz	— —	1.26 1.2	— —	ps

**Notes:**

1. Refer to AN255, AN256, and AN266 for further information.
2. For best jitter and phase noise performance, always choose the smallest K<sub>V</sub> that meets the application's minimum APR requirements. See "AN266: VCXO Tuning Slope (K<sub>V</sub>), Stability, and Absolute Pull Range (APR)" for more information.
3. See "AN255: Replacing 622 MHz VCXO devices with the Si550 VCXO" for comparison highlighting power supply rejection (PSR) advantage of Si55x versus SAW-based solutions.
4. Max jitter for LVPECL output with V<sub>C</sub>=1.65V, V<sub>DD</sub>=3.3V, 155.52 MHz.
5. Max offset frequencies: 80 MHz for F<sub>OUT</sub> ≥ 250 MHz, 20 MHz for 50 MHz ≤ F<sub>OUT</sub> < 250 MHz, 2 MHz for 10 MHz ≤ F<sub>OUT</sub> < 50 MHz.

Table 6. CLK± Output Period Jitter

Parameter	Symbol	Test Condition	Min	Typ	Max	Units
Period Jitter*	J <sub>PER</sub>	RMS	—	2	—	ps
		Peak-to-Peak	—	14	—	

**\*Note:** Any output mode, including CMOS, LVPECL, LVDS, CML. N = 1000 cycles. Refer to AN279 for further information.

**Table 7. CLK± Output Phase Noise (Typical)**

Offset Frequency	74.25 MHz 90 ppm/V LVPECL	155.52 MHz 45 ppm/V LVPECL	491.52 MHz 45 ppm/V LVPECL	622.08 MHz 135 ppm/V LVPECL	Units
100 Hz	-87	-86	-75	-65	dBc/Hz
1 kHz	-114	-111	-100	-90	
10 kHz	-132	-128	-116	-109	
100 kHz	-142	-133	-124	-121	
1 MHz	-148	-144	-135	-134	
10 MHz	-150	-147	-146	-146	
100 MHz	n/a	n/a	-147	-147	

**Table 8. Environmental Compliance**

The Si550 meets the following qualification test requirements.

Parameter	Conditions/Test Method
Mechanical Shock	MIL-STD-883, Method 2002
Mechanical Vibration	MIL-STD-883, Method 2007
Solderability	MIL-STD-883, Method 203
Gross & Fine Leak	MIL-STD-883, Method 1014
Resistance to Solder Heat	MIL-STD-883, Method 2036
Moisture Sensitivity Level	J-STD-020, MSL 1
Contact Pads	J-STD-020, MSL 1

**Table 9. Thermal Characteristics**

(Typical values TA = 25 °C, VDD = 3.3 V)

Parameter	Symbol	Test Condition	Min	Typ	Max	Unit
Thermal Resistance Junction to Ambient	$\theta_{JA}$	Still Air	—	84.6	—	°C/W
Thermal Resistance Junction to Case	$\theta_{JC}$	Still Air	—	38.8	—	°C/W
Ambient Temperature	$T_A$		-40	—	85	°C
Junction Temperature	$T_J$		—	—	125	°C

Table 10. Absolute Maximum Ratings<sup>1</sup>

Parameter	Symbol	Rating	Units
Maximum Operating Temperature	$T_{AMAX}$	85	°C
Supply Voltage, 1.8 V Option	$V_{DD}$	-0.5 to +1.9	V
Supply Voltage, 2.5/3.3 V Option	$V_{DD}$	-0.5 to +3.8	V
Input Voltage	$V_I$	-0.5 to $V_{DD} + 0.3$	V
Storage Temperature	$T_S$	-55 to +125	°C
ESD Sensitivity (HBM, per JESD22-A114)	ESD	2500	V
Soldering Temperature (Pb-free profile) <sup>2</sup>	$T_{PEAK}$	260	°C
Soldering Temperature Time @ $T_{PEAK}$ (Pb-free profile) <sup>2</sup>	$t_P$	20–40	seconds

**Notes:**

1. Stresses beyond those listed in Absolute Maximum Ratings may cause permanent damage to the device. Functional operation or specification compliance is not implied at these conditions. Exposure to maximum rating conditions for extended periods may affect device reliability.
2. The device is compliant with JEDEC J-STD-020C. Refer to Si5xx Packaging FAQ at [https://www.skyworksinc.com/Product\\_Certificate.aspx](https://www.skyworksinc.com/Product_Certificate.aspx) for further information, including soldering profiles.

# Si550

## 2. Pin Descriptions

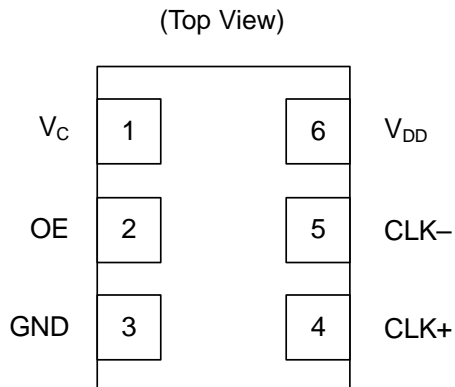

**Table 11. Si550 Pin Descriptions**

Pin	Name	Type	Function
1	$V_C$	Analog Input	Control Voltage
2	OE*	Input	Output Enable (Polarity = High): 0 = clock output disabled (outputs tri-stated) 1 = clock output enabled Output Enable (Polarity = Low): 0 = clock output enabled 1 = clock output disabled (outputs tri-stated)
3	GND	Ground	Electrical and Case Ground
4	CLK+	Output	Oscillator Output
5	CLK- (N/A for CMOS)	Output	Complementary Output (N/C for CMOS, make no external connection)
6	$V_{DD}$	Power	Power Supply Voltage

**\*Note:** OE includes 17 k $\Omega$  pullup resistor to  $V_{DD}$ . See Section 3. "Ordering Information" on page 11 for details on OE polarity ordering options.

### 3. Ordering Information

The Si550 supports a variety of options including frequency, temperature stability, tuning slope, output format, and  $V_{DD}$ . Specific device configurations are programmed into the Si550 at time of shipment. Configurations are specified using the Part Number Configuration chart shown below. Skyworks Solutions provides a web browser-based part number configuration utility to simplify this process. Refer to <https://www.skyworksinc.com/en/Products/Timing> to access this tool and for further ordering instructions. The Si550 VCXO series is available in an industry-standard, RoHS compliant, lead-free, 6-pad, 5 x 7 mm package. Tape and reel packaging is an ordering option.

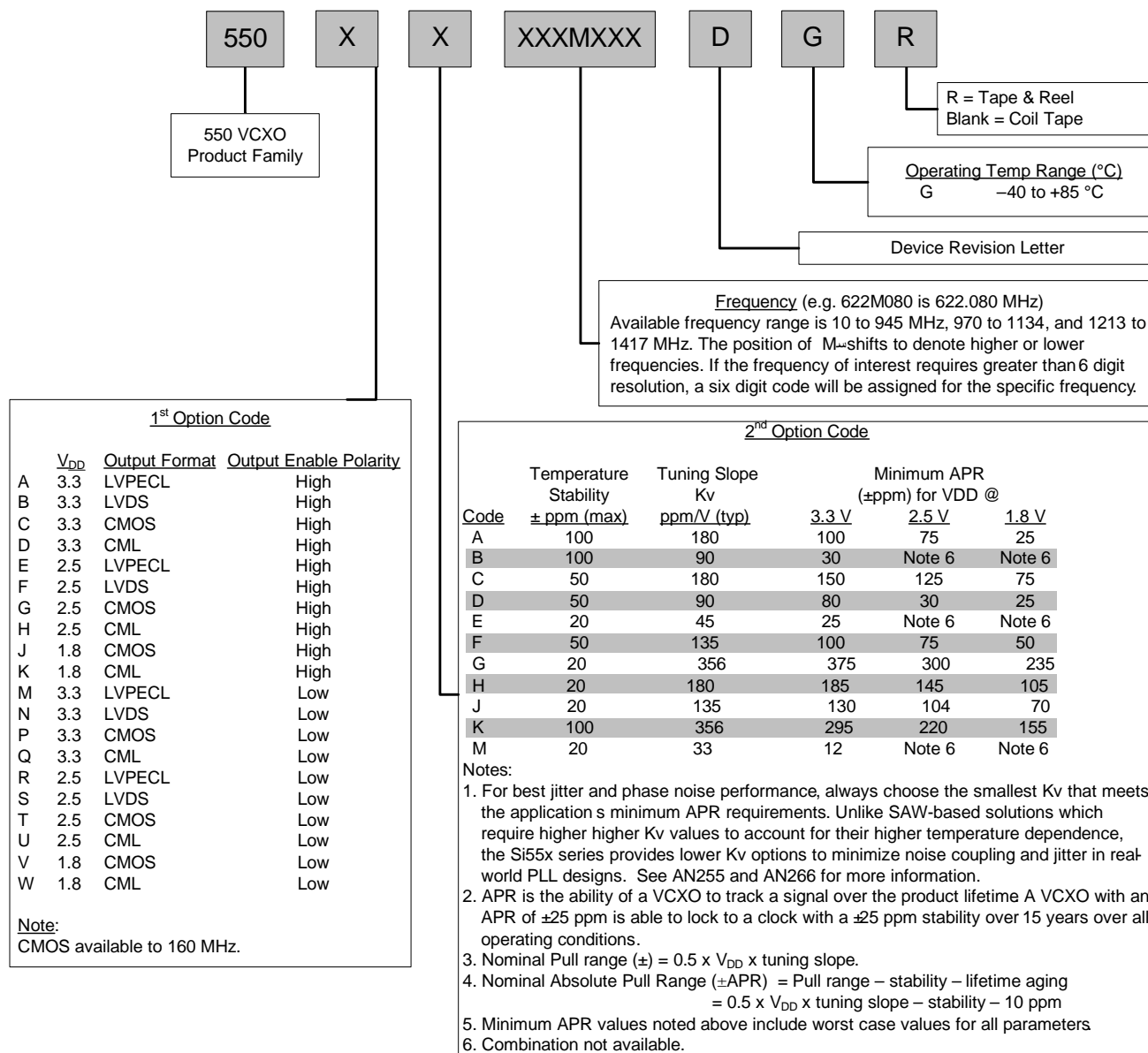

Example Part Number: 550AF622M080DGR is a 5 x 7 mm VCXO in a 6 pad package. The nominal frequency is 622.080 MHz, with a 3.3 V supply, LVPECL output, and Output Enable active high polarity. Temperature stability is specified as  $\pm 50$  ppm and the tuning slope is 135 ppm/V. The part is specified for a  $-40$  to  $+85$   $^{\circ}$ C ambient temperature range operation and is shipped in tape and reel format.

**Figure 1. Part Number Convention**

## 4. Package Outline and Suggested Pad Layout

Figure 2 illustrates the package details for the Si550. Table 12 lists the values for the dimensions shown in the illustration.

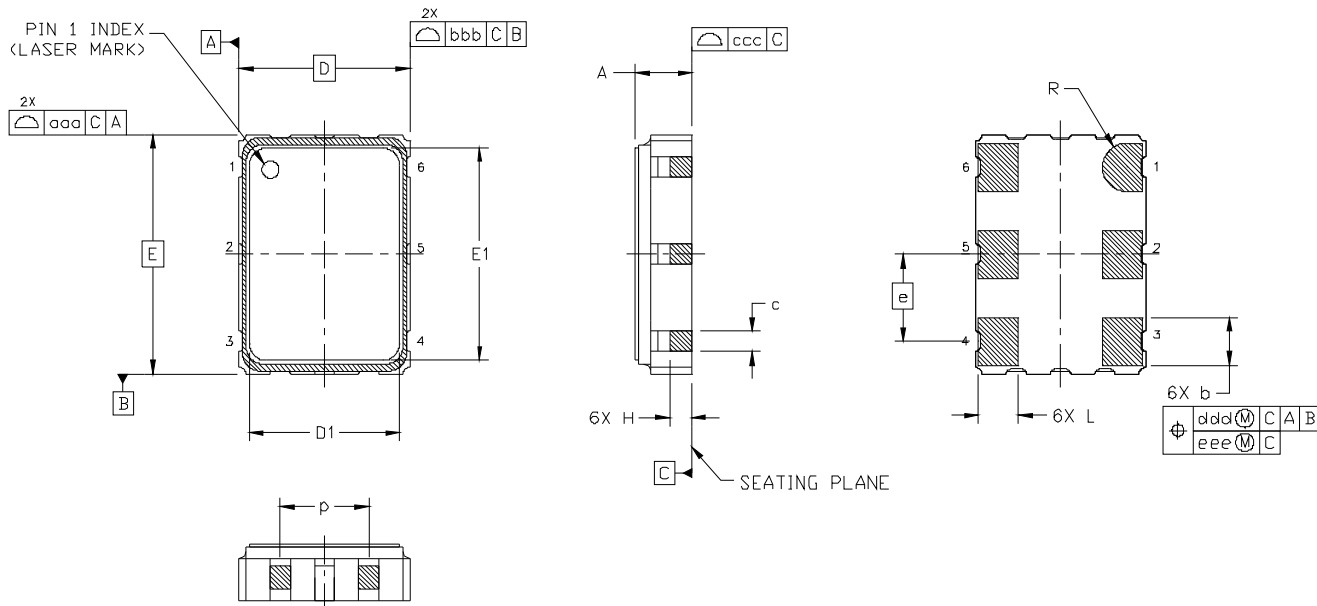

Figure 2. Si550 Outline Diagram

Table 12. Package Diagram Dimensions (mm)

Dimension	Min	Nom	Max
A	1.50	1.65	1.80
b	1.30	1.40	1.50
c	0.50	0.60	0.70
D	5.00 BSC		
D1	4.30	4.40	4.50
e	2.54 BSC.		
E	7.00 BSC.		
E1	6.10	6.20	6.30
H	0.55	0.65	0.75
L	1.17	1.27	1.37
p	1.80	—	2.60
R	0.70 REF		
aaa	0.15		
bbb	0.15		
ccc	0.10		
ddd	0.10		
eee	0.50		

## 5. 6-Pin PCB Land Pattern

Figure 3 illustrates the 6-pin PCB land pattern for the Si550. Table 13 lists the values for the dimensions shown in the illustration.

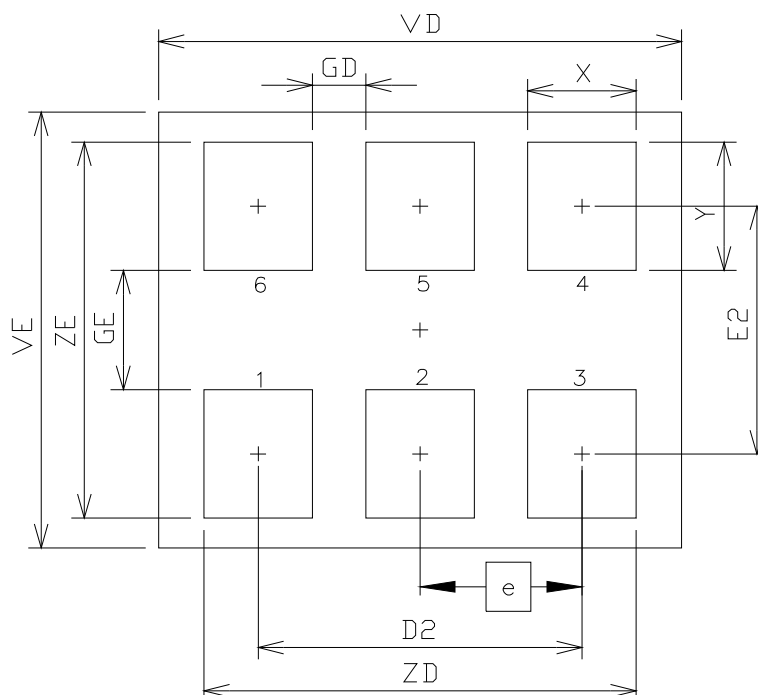

Figure 3. Si550 PCB Land Pattern

Table 13. PCB Land Pattern Dimensions (mm)

Dimension	Min	Max
D2		5.08 REF
e		2.54 BSC
E2		4.15 REF
GD	0.84	—
GE	2.00	—
VD		8.20 REF
VE		7.30 REF
X		1.70 TYP
Y		2.15 REF
ZD	—	6.78
ZE	—	6.30

**Notes:**

1. Dimensioning and tolerancing per the ANSI Y14.5M-1994 specification.
2. Land pattern design based on IPC-7351 guidelines.
3. All dimensions shown are at maximum material condition (MMC).
4. Controlling dimension is in millimeters (mm).

# Si550

## 6. Top Marking

### 6.1. Si550 Top Marking

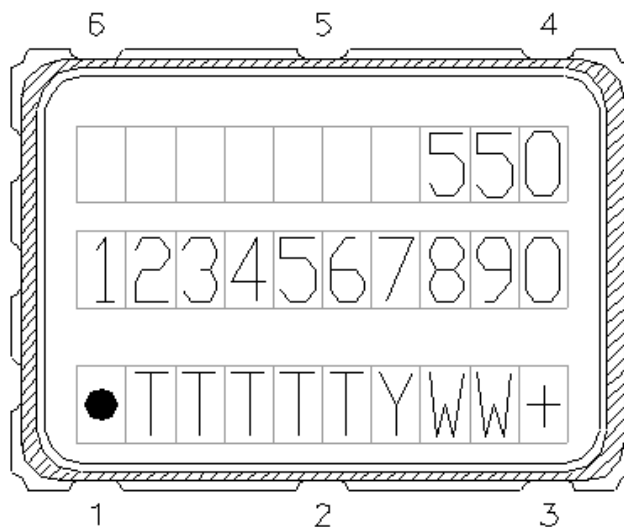

### 6.2. Top Marking Explanation

Line	Position	Description
1	1–10	"Part Family Number, 550 (First 3 characters in part number)
2	1–10	Si550: Option1+Option2+Freq(6007)+Temp
3	<b>Trace Code</b>	
	Position 1	Pin 1 orientation mark (dot)
	Position 2	Product Revision (D)
	Position 3–6	Tiny Trace Code (4 alphanumeric characters per assembly release instructions)
	Position 7	Year (least significant year digit), to be assigned by assembly site (ex: 2010 = 0)
	Position 8–9	Calendar Work Week number (1–53), to be assigned by assembly site
	Position 10	"+" to indicate Pb-Free and RoHS-compliant

---

## DOCUMENT CHANGE LIST

### Revision 0.6 to Revision 1.0

- Updated Table 4 on page 4.
  - Updated 2.5 V/3.3 V and 1.8 V CML output level specifications.
- Updated Table 5 on page 5.
  - Removed the words “Differential Modes: LVPECL/LVDS/CML” in the footnote referring to AN256.
  - Added footnotes clarifying max offset frequency test conditions.
  - Added CMOS phase jitter specs.
- Updated Table 10 on page 9.
  - Separated 1.8 V, 2.5 V/3.3 V supply voltage specifications.
- Updated and clarified Table 8 on page 8
  - Added “Moisture Sensitivity Level” and “Contact Pads” rows.
- Updated 6. “Top Marking” on page 14 to reflect specific marking information (previously, figure was generic).
- Updated 4. “Package Outline and Suggested Pad Layout” on page 12.
  - Added crystal impedance pin in Figure 2 on page 12 and Table 12 on page 12.
- Reordered spec tables and back matter to conform to data sheet quality conventions.

### Revision 1.0 to Revision 1.1

- Added Table 9, “Thermal Characteristics,” on page 8.

### Revision 1.1 to Revision 1.2

June, 2018

- Changed “Trays” to “Coil Tape” in section 3. “Ordering Information”.



## ClockBuilder Pro

One-click access to Timing tools, documentation, software, source code libraries & more. Available for Windows and iOS (CBGo only).

[skyworksinc.com/CBPro](http://skyworksinc.com/CBPro)



Portfolio

[skyworksinc.com](http://skyworksinc.com)



SW/HW

[skyworksinc.com/CBPro](http://skyworksinc.com/CBPro)

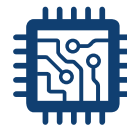

Quality

[skyworksinc.com/quality](http://skyworksinc.com/quality)



Support & Resources

[skyworksinc.com/support](http://skyworksinc.com/support)

**Copyright © 2022 Skyworks Solutions, Inc. All Rights Reserved.**

Information in this document is provided in connection with Skyworks Solutions, Inc. ("Skyworks") products or services. These materials, including the information contained herein, are provided by Skyworks as a service to its customers and may be used for informational purposes only by the customer. Skyworks assumes no responsibility for errors or omissions in these materials or the information contained herein. Skyworks may change its documentation, products, services, specifications or product descriptions at any time, without notice. Skyworks makes no commitment to update the materials or information and shall have no responsibility whatsoever for conflicts, incompatibilities, or other difficulties arising from any future changes.

No license, whether express, implied, by estoppel or otherwise, is granted to any intellectual property rights by this document. Skyworks assumes no liability for any materials, products or information provided hereunder, including the sale, distribution, reproduction or use of Skyworks products, information or materials, except as may be provided in Skyworks' Terms and Conditions of Sale.

THE MATERIALS, PRODUCTS AND INFORMATION ARE PROVIDED "AS IS" WITHOUT WARRANTY OF ANY KIND, WHETHER EXPRESS, IMPLIED, STATUTORY, OR OTHERWISE, INCLUDING FITNESS FOR A PARTICULAR PURPOSE OR USE, MERCHANTABILITY, PERFORMANCE, QUALITY OR NON-INFRINGEMENT OF ANY INTELLECTUAL PROPERTY RIGHT; ALL SUCH WARRANTIES ARE HEREBY EXPRESSLY DISCLAIMED. SKYWORKS DOES NOT WARRANT THE ACCURACY OR COMPLETENESS OF THE INFORMATION, TEXT, GRAPHICS OR OTHER ITEMS CONTAINED WITHIN THESE MATERIALS. SKYWORKS SHALL NOT BE LIABLE FOR ANY DAMAGES, INCLUDING BUT NOT LIMITED TO ANY SPECIAL, INDIRECT, INCIDENTAL, STATUTORY, OR CONSEQUENTIAL DAMAGES, INCLUDING WITHOUT LIMITATION, LOST REVENUES OR LOST PROFITS THAT MAY RESULT FROM THE USE OF THE MATERIALS OR INFORMATION, WHETHER OR NOT THE RECIPIENT OF MATERIALS HAS BEEN ADVISED OF THE POSSIBILITY OF SUCH DAMAGE

Skyworks products are not intended for use in medical, lifesaving or life-sustaining applications, or other equipment in which the failure of the Skyworks products could lead to personal injury, death, physical or environmental damage. Skyworks customers using or selling Skyworks products for use in such applications do so at their own risk and agree to fully indemnify Skyworks for any damages resulting from such improper use or sale.

Customers are responsible for their products and applications using Skyworks products, which may deviate from published specifications as a result of design defects, errors, or operation of products outside of published parameters or design specifications. Customers should include design and operating safeguards to minimize these and other risks. Skyworks assumes no liability for applications assistance, customer product design, or damage to any equipment resulting from the use of Skyworks products outside of Skyworks' published specifications or parameters.



Skyworks, the Skyworks symbol, Sky5®, SkyOne®, SkyBlue™, Skyworks Green™, Clockbuilder®, DSPLL®, ISOMODEM®, ProSLIC®, and SiPHY® are trademarks or registered trademarks of Skyworks Solutions, Inc. or its subsidiaries in the United States and other countries. Third-party brands and names are for identification purposes only and are the property of their respective owners. Additional information, including relevant terms and conditions, posted at [www.skyworksinc.com](http://www.skyworksinc.com), are incorporated by reference.

Skyworks Solutions, Inc. | Nasdaq: SWKS | [sales@skyworksinc.com](mailto:sales@skyworksinc.com) | [www.skyworksinc.com](http://www.skyworksinc.com)

USA: 781-376-3000 | Asia: 886-2-2735 0399 | Europe: 33 (0)1 43548540

## Looking for pricing, stock, or lifecycle information?

Click below to explore more details on WIN SOURCE:

-  [View 550BF156M280DG on WIN SOURCE](#)
-  [Skyworks Solutions Inc. Information](#)

## Optimize Your Supply Chain with WIN SOURCE Solutions

-  Global Sourcing Solution
-  Obsolete Management
-  Cost Control Management
-  Shortage Management
-  Alternative Solution
-  Excess Inventory Management