



**THE DATASHEET OF
407F35D012M0000**



Model 407

Surface Mount Quartz Crystal

Features

- Hermetic Ceramic Surface Mount Package
- Fundamental and 3rd Overtone Crystal Design
- Frequency Range 6 – 160MHz
- Frequency Tolerance, ±30ppm Standard
- Frequency Stability, ±50ppm Standard
- Operating Temperature Range to -40°C to +85°C
- Tape and Reel Packaging, EIA-481

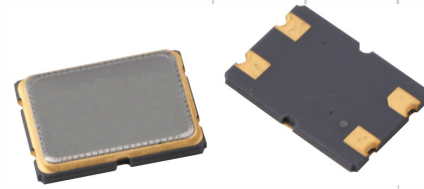

Part Dimensions:
7.0 × 5.0 × 1.3mm • 104.78mg

Standard Frequencies – see Page 5 for common frequencies.
* Check with factory for availability of frequencies not listed.

Applications

- IoT and IIoT Applications
- Wireless Communications
- FPGA/Microcontrollers
- USB Interfaces
- Computer Peripherals
- Portable Equipment
- Test and Measurement
- M2M Communications
- Broadband Access

Description

CTS Model 407 incorporates a high Q quartz resonator and is ideal for supporting a wide range of commercial and industrial applications.

Ordering Information

Model	Mode of Oscillation	Tolerance @ +25°C	Temperature Stability/Temperature Range						Load Capacitance	Frequency [MHz]
407	F	3	5						D	XXXMXXXX
	Code Mode		Code Stability	Code Stability	Code Stability	Code Stability	Code Stability		Code Frequency	
	F Fundamental		-20°C to +70°C	-30°C to +85°C	-40°C to +85°C				Frequency ¹	
	T 3rd Overtone		1 ±10ppm	R ±10ppm	- -					
			X ±15ppm	Y ±15ppm	W ±15ppm					
			2 ±20ppm	N ±20ppm	6 ±20ppm					
			3 ±30ppm	4 ±30ppm	7 ±30ppm					
			5 ±50ppm	8 ±50ppm	9 ±50ppm					
		Code Tolerance						Code Capacitance	Code Capacitance	
		1 ±10ppm						K 8pF	D 18pF	
		X ±15ppm						J 9pF	E 20pF	
		2 ±20ppm						A 10pF	F 24pF	
		3 ±30ppm						L 12pF	G 30pF	
								C 16pF	S Series	

Notes:

- 1] Frequency is recorded with 3 leading digits before the "M" and 4 significant digits after the "M" [including zeroes]. (Ex. XXXMXXXX [016M3840], There are frequencies with significant digits after the "M" that exceed the 4 digits. The remaining digits will be truncated from the CTS part number, but the factory will calibrate to the full frequency desired. Examples below; P/N Frequency = Actual Frequency
 13M5537 = 13.553750MHz 14M3181 = 14.318180MHz 16M6666 = 16.666670MHz 28M6363 = 28.636360MHz

Not all performance combinations and frequencies may be available.
Contact your local CTS Representative or CTS Customer Service for availability.

This product is specified for use only in standard commercial applications. Supplier disclaims all express and implied warranties and liability in connection with any use of this product in any non-commercial applications or in any application that may expose the product to conditions that are outside of the tolerances provided in its specification.



Electrical Specifications

Operating Conditions

PARAMETER	SYMBOL	CONDITIONS	MIN	TYP	MAX	UNIT
Operating Temperature	T _A	-	-20		+70	°C
			-30	+25	+85	
			-40		+85	
			-40		+105	
Storage Temperature	T _{STG}	-	-55	-	+125	°C

Frequency Stability

PARAMETER	SYMBOL	CONDITIONS	MIN	TYP	MAX	UNIT
Frequency Range	f ₀	Fundamental Mode		6 - 50		MHz
		3rd Overtone Mode		50 - 160		MHz
Frequency Tolerance	Δf/f ₀	@ +25°C		10, 15, 20, 25 or 30		±ppm
Frequency Stability	Δf/f ₂₅	Referenced to +25°C reading		10, 15, 20, 25, 30 or 50		±ppm
Aging	Δf/f ₀	Typical per year @ +25°C	-3	-	3	ppm

Crystal Parameters

PARAMETER	SYMBOL	CONDITIONS	MIN	TYP	MAX	UNIT
Operating Mode	-	-	Fundamental & 3rd Overtone			-
Crystal Cut	-	-	AT-Cut Strip			-
Load Capacitance	C _L	-	See Ordering Information			pF
Shunt Capacitance	C ₀	-	-	5.0	7.0	pF
Series Resistance						
Fundamental	R ₁	6MHz - <12MHz	-	-	100	Ω
		12MHz - <14MHz	-	-	60	
		14MHz - <20MHz	-	-	50	
		20MHz - 50MHz	-	-	40	
3rd Overtone	R ₁	50MHz - <80MHz	-	-	80	
		80MHz - <100MHz	-	-	70	
		100MHz - 160MHz	-	-	50	
Drive Level	DL	-	-	10	300	μW
Insulation Resistance	R _i	+100Vdc ±15Vdc	500	-	-	MΩ

Δf/f₀ - Frequency deviation referenced to nominal frequency.

Δf/f₂₅ - Frequency deviation over operating temperature range, referenced to +25°C frequency.

Mechanical Specifications

Package Drawing

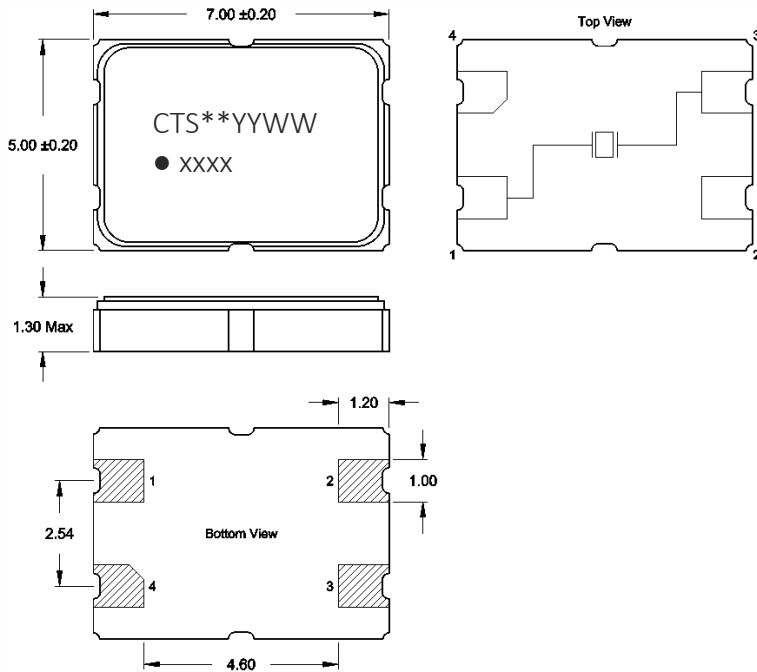

Marking Information

1. ** – Manufacturing Site Code.
2. YYWW – Date Code. YY = year, WW = week.
3. xxx or xxxx – Frequency Code.
3-digits, frequencies below 100MHz
4-digits, frequencies 100MHz or greater
[See document 016-1454-0, Frequency Code Tables.]

Recommended Pad Layout

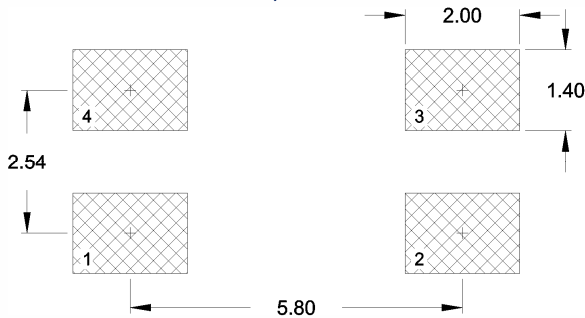

Notes

1. JEDEC termination code (e4). Barrier-plating is nickel [Ni] with gold [Au] flash plate.
2. Terminations #2, #4 and the metal lid are connected internally. End user may connect these pins to circuit ground for EMI suppression.
3. Due to package variability, the pad chamfer on the bottom could be located on Pin 4 in a given lot. Layout orientation should be based on the top view [marking side], as indicated in package drawing. The chamfer location does not affect the electrical performance of the device.
4. Reflow conditions per JEDEC J-STD-020; +260°C maximum, 20 seconds.
5. MSL = 1.

Packaging – Tape and Reel

Tape Drawing

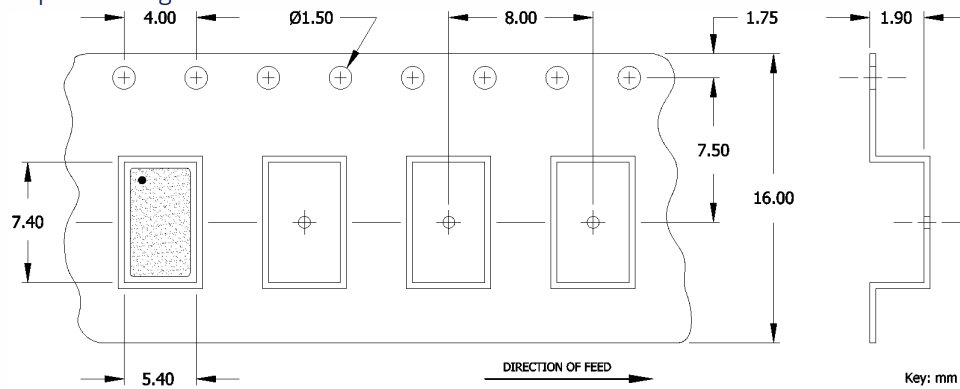

Reel Drawing

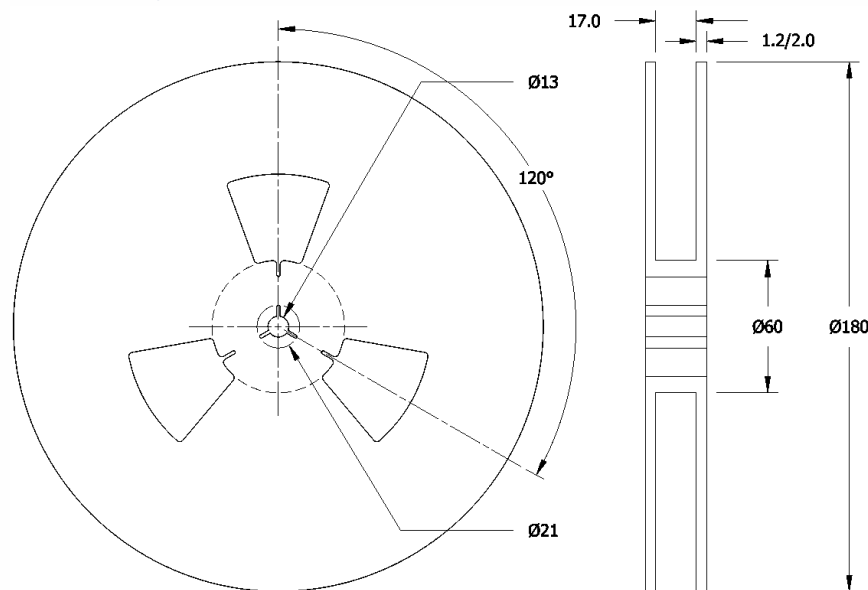

Notes

1. Device quantity is 1k pieces maximum per 180mm reel.
2. Complete CTS part number, frequency value, date code and manufacturing site code information must appear on reel and carton labels.





Addendum

Common Frequencies and Frequency Codes – MHz

Common Wireless Frequencies			Additional Frequencies					
FREQUENCY	PART NUMBER CODE	MARKING CODE	FREQUENCY	PART NUMBER CODE	MARKING CODE	FREQUENCY	PART NUMBER CODE	MARKING CODE
12.000000	012M000	120	8.000000	008M0000	080	24.553500	024M5535	24B
13.560000	013M560	13C	8.192000	008M1920	081	24.576000	024M5760	24C
16.000000	016M000	160	10.000000	010M0000	100	25.000625	025M0006	25A
19.200000	019M200	192	11.059200	011M0592	111	26.041660	026M0416	26F
20.000000	020M000	200	12.288000	012M2880	122	27.000000	027M0000	270
24.000000	024M000	240	12.500000	012M5000	125	28.224000	028M2240	282
25.000000	025M000	250	12.800000	012M8000	128	28.322000	028M3220	28C
26.000000	026M000	260	12.996000	012M9960	12C	28.375000	028M3750	283
27.120000	027M120	271	13.000000	013M0000	130	28.636360	028M6363	286
30.000000	030M000	300	13.500000	013M5000	135	29.491200	029M4912	29B
32.000000	032M000	320	13.553750	013M5537	13B	30.328000	030M3280	303
37.400000	037M400	374	13.824000	013M8240	138	30.400000	030M4000	304
38.400000	038M400	384	14.000000	014M0000	140	30.720000	030M7200	307
40.000000	040M000	400	14.318180	014M3181	143	31.250000	031M2500	312
48.000000	048M000	480	14.400000	014M4000	144	32.768000	032M7680	327
52.000000	052M000	520	14.745600	014M7456	147	33.000000	033M0000	330
			15.360000	015M3600	153	33.330000	033M3300	333
			16.367600	016M3676	16E	33.333000	033M3330	33E
			16.368000	016M3680	16C	33.333300	033M3333	33A
			16.384000	016M3840	163	33.868800	033M8688	338
			16.666000	016M6660	166	35.000000	035M0000	350
			16.666700	016M6667	16N	35.328000	035M3280	353
			16.667000	016M6670	16P	36.000000	036M0000	360
			16.800000	016M8000	168	38.000000	038M0000	380
			16.934400	016M9344	169	38.880000	038M8800	388
			18.000000	018M0000	180	39.062500	039M0625	39A
			18.432000	018M4320	184	41.600000	041M6000	41C
			19.000000	019M0000	190	44.000000	044M0000	440
			19.440000	019M4400	194	45.000000	045M0000	450
			19.660800	019M6608	19B	49.152000	049M1520	491
			19.680000	019M6800	196	50.000000	050M0000	500
			19.800000	019M8000	198	54.000000	054M0000	540
			20.480000	020M4800	204	114.285000	114M2850	1142
			20.736000	020M7360	207	156.250000	156M2500	1562
			22.000000	022M0000	220			
			22.118400	022M1184	221			
			22.579200	022M5792	225			
			24.305000	024M3050	243			
			24.545400	024M5454	24F			
			24.545454	024M5455	24G			

Looking for pricing, stock, or lifecycle information?

Click below to explore more details on WIN SOURCE:

-  [View 407F35D012M0000 on WIN SOURCE](#)
-  [CTS-Frequency Controls](#) Information

Optimize Your Supply Chain with WIN SOURCE Solutions

-  Global Sourcing Solution
-  Obsolete Management
-  Cost Control Management
-  Shortage Management
-  Alternative Solution
-  Excess Inventory Management