

369 Series

TE5® Time-Lag Fuse

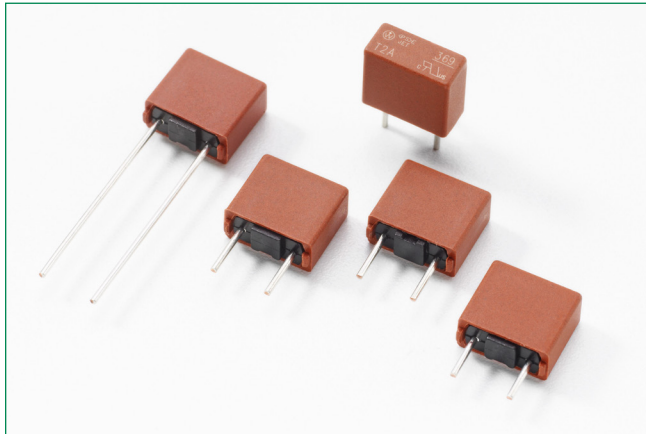

Description

The 369 Series are TE5® Time-Lag Fuses, 300V rated and designed in accordance to IEC 60127-3.

Features

- Halogen free, Lead-free and RoHS compliant
- Reduced PCB space requirements
- Direct solderable or plug-in versions
- Internationally approved
- Low internal resistance
- Shock safe casing
- Vibration resistant
- Recognized to UL/CSA/NMX 248-1 and UL/CSA/NMX 248-14
- Conforms to EN/J 60127-1 and EN/J 60127-3

Agency Approvals

Agency	Agency File/Certificate Number	Ampere Range
	E67006	0.800A - 6.3A
	JET 1896-31007-2002	1A - 5A
	40037351	1A - 6.3A

Applications

- Electronic Ballast

Electrical Characteristics

% of Ampere Rating	Opening Time
150%	1 Hour, Minimum
210%	120 sec., Maximum
275%	400 ms., Min.; 10 sec., Max.
400%	150 ms., Min.; 3 sec., Max.
1000%	20 ms., Min.; 150 ms., Max.

Additional Information



Resources



Accessories



Samples

Electrical Characteristics

Amp Code	Amp Rating, I _n (A)	Voltage Rating (V)	Breaking Capacity	Nominal Cold Resistance (Ohms) ¹	Voltage Drop 1.0 × I _N max. (mV)	Power Dissipation 1.5 × I _N max. (mW)	Melting Integral 10 × I _N max. (A2s)	Agency Approvals		
0800	0.800	300	50A @300VAC	0.0960	110	280	5.1200	x		
1100	1.00	300		0.0715	115	400	8.0000	x	x	x
1160	1.60	300		0.0400	95	600	18.4320	x	x	x
1200	2.00	300		0.0298	90	700	29.0000	x	x	x
1315	3.15	300		0.0170	80	1100	78.3880	x	x	x
1400	4.00	300		0.0128	75	1200	126.4000	x	x	x
1500	5.00	300		0.0101	70	1000	106.2500	x	x	x
1630	6.30	300		0.0077	65	1200	160.7400	x		x

Note:

1. Resistance is measured at 10% of rated current, 25°C.

369 Series

TE5® Time-Lag Fuse

Temperature Re-rating Curve

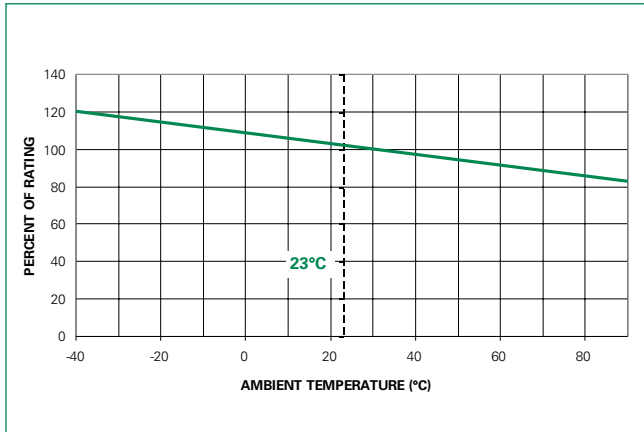

Note:
1. Rerating depicted in this curve is in addition to the standard derating of 25% for continuous operation.

Average Time Current Curves

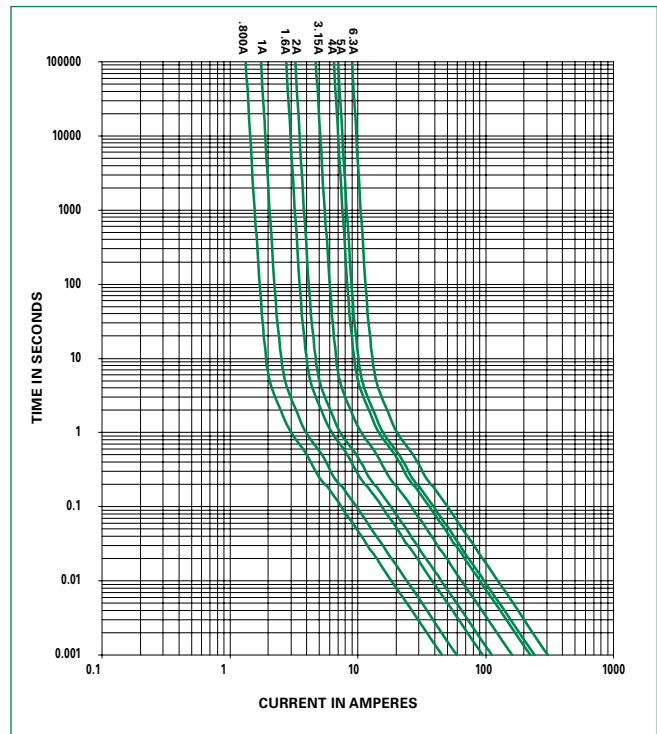

Soldering Parameters - Wave Soldering

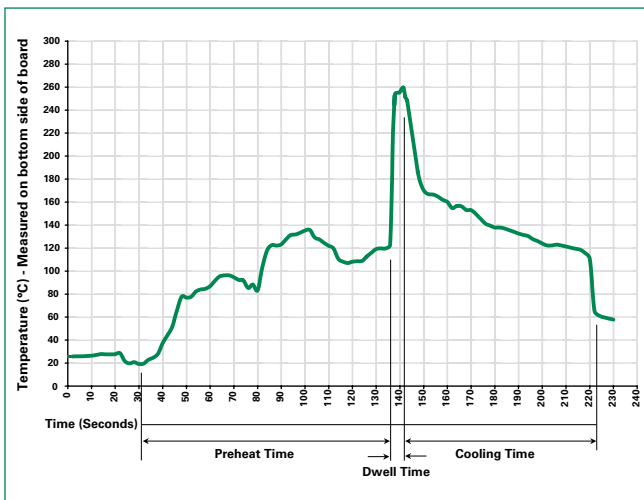

Recommended Process Parameters:

Wave Parameter	Lead-Free Recommendation
Preheat: (Depends on Flux Activation Temperature)	(Typical Industry Recommendation)
Temperature Minimum:	100°C
Temperature Maximum:	150°C
Preheat Time:	60-180 seconds
Solder Pot Temperature:	260°C Maximum
Solder Dwell Time:	2-5 seconds

Recommended Hand-Solder Parameters:

Solder Iron Temperature: 350°C +/- 5°C
Heating Time: 5 seconds max.

Note: These devices are not recommended for IR or Convection Reflow process.

369 Series

TE5® Time-Lag Fuse

Product Characteristics

Materials	Base/Cap: Black/Brown Thermoplastic Polyamide PA 6.6, UL 94 V0 Round Pins: Tin-plated Copper
Lead Pull Strength	10N (IEC 60068-2-21)
Solderability	260°C, ≤ 3s. (Wave) 350°C, ≤ 1s. (Soldering Iron)
Soldering Heat Resistance	260°C, 10s. (IEC 60068-2-20) 350°C, 3s. (Soldering Iron)

Operating Temperature	-40°C to +85°C (consider re-rating)
Climatic Category	-40°C to +85°C/21 days (IEC 60068-1,-2-1,-2-2,-2-78)
Stock Conditions	+10°C to +60°C RH, ≤ 75% yearly average, without dew, maximum value for 30 days-95%
Vibration Resistance	24 cycles at 15 min. each (IEC 60068-2-6) 10 - 60Hz at 0.75mm amplitude 60 - 2000Hz at 10g acceleration

Dimensions (mm)

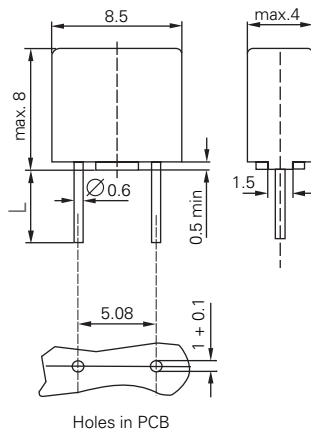

Long Leads (L=18.8mm)
Short Leads (L=4.3mm)

Part Numbering System

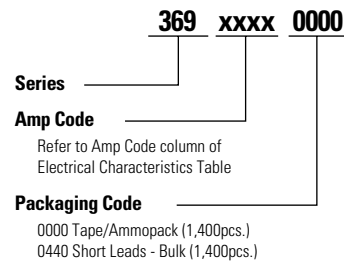

Packaging

Packaging Option	Packaging Specification	Quantity	Quantity & Packaging Code	Taping Width
369 Series				
Tape & Ampack	N/A	1,400	0000	N/A
Short Leads	N/A	1,400	0440	N/A

Disclaimer Notice - Information furnished is believed to be accurate and reliable. However, users should independently evaluate the suitability of and test each product selected for their own applications. Littelfuse products are not designed for, and may not be used in, all applications. Read complete Disclaimer Notice at: www.littelfuse.com/disclaimer-electronics.

Looking for pricing, stock, or lifecycle information?

Click below to explore more details on WIN SOURCE:

 [View 36912000000 on WIN SOURCE](#)

 [Littelfuse Inc. Information](#)

Optimize Your Supply Chain with WIN SOURCE Solutions

-  Global Sourcing Solution
-  Obsolete Management
-  Cost Control Management
-  Shortage Management
-  Alternative Solution
-  Excess Inventory Management