



**THE DATASHEET OF
3.0SMCJ20AQ-13**





New Product Announcement

Automotive Grade
SMAJ/SMBJ/SMCJ/
3.0SMCJ TVS

Automotive Grade SMAJ/SMBJ/SMCJ/3.0SMCJ TVS

Diodes Incorporated is introducing a range of 84 new automotive-compliant transient voltage suppressors (TVS) packaged in a choice of SMA, SMB or SMC packages.

Designed to protect sensitive electronic circuits from powerline transients generated by inductive switching, these devices target a wide range of automotive applications including pumps, HVAC, infotainment, navigation and ADAS.

Featuring a choice of reverse stand-off voltage from 14V to 36V these new automotive-compliant TVS are offered as unidirectional or bidirectional devices and are able to dissipate up to 400W (SMA), 600W (SMB) and 3000W (SMC) per 10/1000µs pulse transient.

All devices comply with the automotive load dump standard ISO7637-2 (pulses 1, 2a, 2b, 3) and ESD standard ISO10605.



The Diodes Advantage

- **AEC-Q101 Qualified and PPAP Supported**

These devices are qualified to high reliability qualification standards in accordance with AEC-Q101 and supported by a production part approval procedure (PPAP).

- **ISO 10605 Compliance**

These parts are suitable to protect sensitive automotive circuits against electrostatic discharges according to ISO10605.

- **ISO 7637-2 Compliance**

These parts are suitable to protect sensitive automotive circuits against surges defined in ISO7637-2 (pulses 1, 2a, 2b and 3).

- **High Forward Surge Current Capability and Excellent Clamping Capability**

The high forward surge overload rating and excellent clamping capability ensures more rugged applications and improves device reliability.

Applications

- Advanced Driver Assistance Systems (ADAS)
- Infotainment
- Navigation
- HVAC (Heating, Ventilation & Air Conditioning)
- Body Control Modules



New Product Announcement

Automotive Grade
SMAJ/SMBJ/SMCJ/
3.0SMCJ TVS

Circuit Function

Powerline protection of automotive Electronic Control Units (ECU) is important to avoid surge voltages, generated by the alternator or other inductive loads (motors), passing through to sensitive electronics. Thus powerline protection is required for almost all automotive electronics.

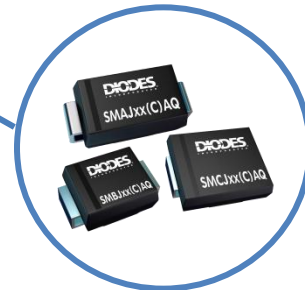
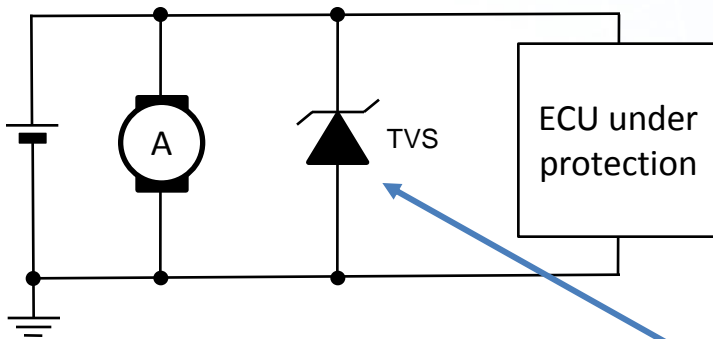

Package Outline Dimensions

SMA		
Dim	Min	Max
A	2.29	2.92
B	4.00	4.60
C	1.27	1.63
D	0.15	0.31
E	4.80	5.59
G	0.05	0.20
H	0.76	1.52
J	1.96	2.40
All Dimensions in mm		

SMB		
Dim	Min	Max
A	3.30	3.94
B	4.06	4.57
C	1.96	2.21
D	0.15	0.31
E	5.00	5.59
G	0.05	0.20
H	0.76	1.52
J	2.00	2.50
All Dimensions in mm		

SMC		
Dim	Min	Max
A	5.59	6.22
B	6.60	7.11
C	2.75	3.18
D	0.15	0.31
E	7.75	8.13
G	0.10	0.20
H	0.76	1.52
J	2.00	2.50
All Dimensions in mm		

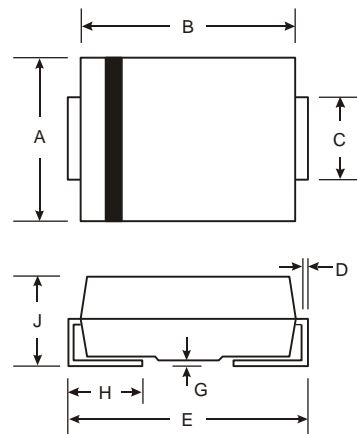



New Product Announcement

Automotive Grade
SMAJ/SMBJ/SMCJ/
3.0SMCJ TVS

Product Portfolio

Part Number	Reverse Standoff Voltage VRWM	Breakdown Voltage VBR @ I _T		Max. Reverse Leakage @ V	Max. Clamping Voltage @ I _{pp}	Max. Peak Pulse Current I _{pp}	Competitor near Equivalent
	(V)	Min (V)	Max (V)	IR(μA)	Vc(V)	(A)	
SMAJ14(C)AQ	14	15.6	17.2	5.0	23.2	17.2	SZ1SMA14(C)AT3G, SMAJ14(C)AHM3/I, SMAJ14(C)AHE2G
SMAJ15(C)AQ	15	16.7	18.5	5.0	24.4	16.4	SZ1SMA15(C)AT3G, SMAJ15(C)AHM3/I, SMAJ15(C)AHE2G
SMAJ16(C)AQ	16	17.8	19.7	5.0	26.0	15.3	SZ1SMA16(C)AT3G, SMAJ16(C)AHM3/I, SMAJ16(C)AHE2G
SMAJ17(C)AQ	17	18.9	20.9	5.0	27.6	14.5	SZ1SMA17(C)AT3G, SMAJ17(C)AHM3/I, SMAJ17(C)AHE2G
SMAJ18(C)AQ	18	20.0	22.1	5.0	29.2	13.7	SZ1SMA18(C)AT3G, SMAJ18(C)AHM3/I, SMAJ18(C)AHE2G, SM4TY21(C)AY
SMAJ20(C)AQ	20	22.2	24.5	5.0	32.4	12.3	SZ1SMA20(C)AT3G, SMAJ20(C)AHM3/I, SMAJ20(C)AHE2G, SM4TY23(C)AY
SMAJ22(C)AQ	22	24.4	26.9	5.0	35.5	11.2	SZ1SMA22(C)AT3G, SMAJ22(C)AHM3/I, SMAJ22(C)AHE2G, SM4TY26(C)AY
SMAJ24(C)AQ	24	26.7	29.5	5.0	38.9	10.3	SZ1SMA24(C)AT3G, SMAJ24(C)AHM3/I, SMAJ24(C)AHE2G, SM4TY28(C)AY
SMAJ26(C)AQ	26	28.9	31.9	5.0	42.1	9.5	SZ1SMA26(C)AT3G, SMAJ26(C)AHM3/I, SMAJ26(C)AHE2G, SM4TY30(C)AY
SMAJ28(C)AQ	28	31.1	34.4	5.0	45.4	8.8	SZ1SMA28(C)AT3G, SMAJ28(C)AHM3/I, SMAJ28(C)AHE2G, SM4TY33(C)AY
SMAJ30(C)AQ	30	33.3	36.8	5.0	48.4	8.3	SZ1SMA30(C)AT3G, SMAJ30(C)AHM3/I, SMAJ30(C)AHE2G, SM4TY35(C)AY
SMAJ33(C)AQ	33	36.7	40.6	5.0	53.3	7.5	SZ1SMA33(C)AT3G, SMAJ33(C)AHM3/I, SMAJ33(C)AHE2G, SM4TY39(C)AY
SMAJ36(C)AQ	36	40.0	44.2	5.0	58.1	6.9	SZ1SMA36(C)AT3G, SMAJ36(C)AHM3/I, SMAJ36(C)AHE2G
SMBJ14(C)AQ	14.0	15.60	17.90	5.0	23.2	25.8	SZ1SMB14(C)AT3G, SMBJ14(C)AHM3/I, SMBJ14(C)AHM4G, SM6T16V5(C)AY
SMBJ15(C)AQ	15.0	16.70	19.20	5.0	24.4	24.0	SZ1SMB15(C)AT3G, SMBJ15(C)AHM3/I, SMBJ15(C)AHM4G, SM6TY18(C)AY
SMBJ16(C)AQ	16.0	17.80	20.50	5.0	26.0	23.1	SZ1SMB16(C)AT3G, SMBJ16(C)AHM3/I, SMBJ16(C)AHM4G
SMBJ17(C)AQ	17.0	18.90	21.70	5.0	27.6	21.7	SZ1SMB17(C)AT3G, SMBJ17(C)AHM3/I, SMBJ17(C)AHM4G
SMBJ18(C)AQ	18.0	20.00	23.30	5.0	29.2	20.5	SZ1SMB18(C)AT3G, SMBJ18(C)AHM3/I, SMBJ18(C)AHM4G, SM6TY22(C)AY
SMBJ20(C)AQ	20.0	22.20	25.50	5.0	32.4	18.5	SZ1SMB20(C)AT3G, SMBJ20(C)AHM3/I, SMBJ20(C)AHM4G
SMBJ22(C)AQ	22.0	24.40	28.00	5.0	35.5	16.9	SZ1SMB22(C)AT3G, SMBJ22(C)AHM3/I, SMBJ22(C)AHM4G
SMBJ24(C)AQ	24.0	26.70	30.70	5.0	38.9	15.4	SZ1SMB24(C)AT3G, SMBJ24(C)AHM3/I, SMBJ24(C)AHM4G
SMBJ26(C)AQ	26.0	28.90	33.20	5.0	42.1	14.2	SZ1SMB26(C)AT3G, SMBJ26(C)AHM3/I, SMBJ26(C)AHM4G
SMBJ28(C)AQ	28.0	31.10	35.80	5.0	45.4	13.2	SZ1SMB28(C)AT3G, SMBJ28(C)AHM3/I, SMBJ28(C)AHM4G
SMBJ30(C)AQ	30.0	33.30	38.30	5.0	48.4	12.4	SZ1SMB30(C)AT3G, SMBJ30(C)AHM3/I, SMBJ30(C)AHM4G
SMBJ33(C)AQ	33.0	36.70	42.20	5.0	53.3	11.3	SZ1SMB33(C)AT3G, SMBJ33(C)AHM3/I, SMBJ33(C)AHM4G, SM6TY39(C)AY
SMBJ36(C)AQ	36.0	40.00	46.00	5.0	58.1	10.3	SZ1SMB36(C)AT3G, SMBJ36(C)AHM3/I, SMBJ36(C)AHM4G



New Product Announcement

Automotive Grade
SMAJ/SMBJ/SMCJ/
3.0SMCJ TVS

Product Portfolio Continued

Part Number	Reverse Standoff Voltage VRWM	Breakdown Voltage VBR @ I _T		Max. Reverse Leakage @ V	Max. Clamping Voltage @ I _{pp}	Max. Peak Pulse Current I _{pp}	Competitor near Equivalent
	(V)	Min (V)	Max (V)	IR(μA)	Vc(V)	(A)	
SMCJ14(C)AQ	14.0	15.60	17.2	5.0	23.2	64.7	SMCJ14(C)AHM3/I, SMCJ14(C)AHR6G
SMCJ15(C)AQ	15.0	16.70	18.5	5.0	24.4	61.5	SMCJ15(C)AHM3/I, SMCJ15(C)AHV6G
SMCJ16(C)AQ	16.0	17.80	19.7	5.0	26.0	57.7	SMCJ16(C)AHM3/I, SMCJ16(C)AHV6G
SMCJ17(C)AQ	17.0	18.90	20.9	5.0	27.6	53.3	SMCJ17(C)AHM3/I, SMCJ17(C)AHV6G, TPSMC20(C)A
SMCJ18(C)AQ	18.0	20.00	22.1	5.0	29.2	51.4	SMCJ18(C)AHM3/I, SMCJ18(C)AHV6G
SMCJ20(C)AQ	20.0	22.20	24.5	5.0	32.4	46.3	SMCJ20(C)AHM3/I, SMCJ20(C)AHV6G
SMCJ22(C)AQ	22.0	24.40	27.0	5.0	35.5	42.2	SMCJ22(C)AHM3/I, SMCJ22(C)AHV6G
SMCJ24(C)AQ	24.0	26.70	29.5	5.0	38.9	38.6	SMCJ24(C)AHM3/I, SMCJ24(C)AHV6G
SMCJ26(C)AQ	26.0	28.90	31.9	5.0	42.1	35.6	SMCJ26(C)AHM3/I, SMCJ26(C)AHV6G
SMCJ28(C)AQ	28.0	31.10	34.4	5.0	45.4	33.0	SMCJ28(C)AHM3/I, SMCJ28(C)AHV6G
SMCJ30(C)AQ	30.0	33.30	36.8	5.0	48.4	31.0	SMCJ30(C)AHM3/I, SMCJ30(C)AHV6G
SMCJ33(C)AQ	33.0	36.70	40.6	5.0	53.3	28.1	SMCJ33(C)AHM3/I, SMCJ33(C)AHV6G
SMCJ36(C)AQ	36.0	40.00	44.2	5.0	58.1	25.8	SMCJ36(C)AHM3/I, SMCJ36(C)AHV6G
3.0SMCJ14AQ	14.0	15.60	17.2	5.0	23.2	129.3	TPSMD14A, SMDJ14A
3.0SMCJ20AQ	20.0	22.20	24.5	5.0	32.4	92.6	TPSMD20A, SM30T23AY, SMDJ20A
3.0SMCJ22AQ	22.0	24.40	27.0	5.0	35.5	84.5	TPSMD22A, SM30T26AY, SMDJ22A
3.0SMCJ24AQ	24.0	26.70	29.5	5.0	38.9	77.1	TPSMD24A, SM30T28AY, SMDJ24A
3.0SMCJ28AQ	28.0	31.10	34.4	5.0	45.4	66.1	TPSMD28A, SM30T33AY, SMDJ28A
3.0SMCJ30AQ	30.0	33.30	36.8	5.0	48.4	62.0	TPSMD30A, SM30T35AY, SMDJ30A







Looking for pricing, stock, or lifecycle information?

Click below to explore more details on WIN SOURCE:

 [View 3.0SMCJ20AQ-13](#) on WIN SOURCE

 [Diodes Incorporated](#) Information

Optimize Your Supply Chain with WIN SOURCE Solutions

-  Global Sourcing Solution
-  Obsolete Management
-  Cost Control Management
-  Shortage Management
-  Alternative Solution
-  Excess Inventory Management