

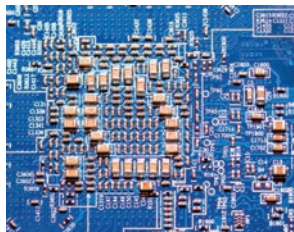

**THE DATASHEET OF
202R18W102MV4E**



Ceramic Component Solutions



AC Safety Certified

High Voltage SMT

High Capacitance

High Temperature

EMI Filters

SMPS Stacks

High Voltage Radials

Planar Array

Discoidal

CapStrate[®]

Custom Solutions



YOUR TECHNOLOGY PARTNER



The mission of the Johanson Companies is to translate our customer needs into quality electronic components, produced in factories that are models of excellence, supported by innovative service. With over 30 years of experience, Johanson Dielectrics provides both standard and custom technology solutions tailored to your specific electronic applications.

Our standard product range includes High Voltage and AC Safety Capacitors providing solutions for Lighting, IT and Business Equipment designs. Our Capacitor line provides advanced EMI filtering and IC decoupling solutions and our High Capacitance Tanceram® products provide the highest capacitance values in the smallest cases sizes.

Customized solutions in the areas of High Temperature and High AC power ceramic capacitors are available to customers who require a partnered technology solution.

Johanson Dielectrics design and manufacturing operations are located in Sylmar, California and Zhaoqing, PRC. Our quality minded management system utilizes continuous improvement programs focused on increased product reliability, manufacturing through-put, and product performance. Our broad experience, applications support, and responsive service enhance our ability to drive down your total cost of procurement and speed your time to market.

HIGH FREQUENCY CERAMIC SOLUTIONS

Johanson Technology Inc., Camarillo CA. Products include High Q Capacitors, Ceramic and Wire-wound Chip Inductors, and a broad range of LTCC based RF IPCs such as Antennas, Filters, Baluns, Couplers, Matched Filter Baluns, etc.

www.johansontechnology.com

Johanson Dielectrics, Inc. reserves the right to make design and price changes without notice. All sales are subject to the Johanson terms and conditions, including a limited warranty and remedies for non-conforming goods or defective goods. Download the Johanson terms and conditions from our website at <https://www.johansondielectrics.com/terms-and-conditions>.



INDEX OF PRODUCTS

SURFACE MOUNT CERAMIC CAPACITORS

| | |
|---|-------|
| Ceramic Capacitor Prototyping Kits | 4-5 |
| High Voltage Capacitors 250 - 6,000 VDC | 6-7 |
| Safety Capacitors 250 VAC, Y2, X1, X2 | 8-9 |
| EMI Filter & Decoupling Capacitors | 10-13 |
| High Temperature 200°C Capacitors | 14-15 |
| High Capacitance Tanceram® Capacitors | 16-17 |
| SMT Multi-layer Ceramic Capacitors 10 - 200 VDC | 18-19 |

LEADED CERAMIC CAPACITORS

| | |
|--|-------|
| SMPS Stacked Capacitors, 125°C & 200°C versions | 20-21 |
| Mini-SMPS Stacked Capacitors | 22-23 |
| BME Mini SMPS Capacitors | 24-25 |
| Switch-mode Radial Leaded Capacitors | 26-27 |
| High Voltage Radial Leaded Capacitors, 125°C, 200°C versions | 28-29 |

PLANAR CAPACITORS & CUSTOM CERAMIC SOLUTIONS

| | |
|-------------------------|-------|
| Planar Array Capacitors | 30-31 |
|-------------------------|-------|

CAPSTRATE & CUSTOMER CERAMIC SOLUTIONS

| | |
|---|-------|
| CapStrate® & Customer Ceramic Solutions | 32-33 |
|---|-------|

PART NUMBER, DIELECTRIC, PACKAGING SPECIFICATIONS, INDEX

| | |
|---|----|
| Capacitor General Electrical Characteristics and PN Breakdown | 34 |
| Capacitor Packaging | 35 |
| Index | 36 |



CERAMIC CAPACITOR ENGINEERING DESIGN KITS

Johanson Dielectrics, Inc. offers a variety of multi-layer chip capacitor sample kits for proto-type design work. Each kit is grouped by type, size, or voltage and contains a selection of popular values and tolerances. The chips are individually packaged in labeled plastic compartments for easy access. The general range of kit contents is described below. Specific part number details may be found at www.johansondielectrics.com



| 500 VDC Ceramic Chip Capacitor Kit | | | | | P/N: S-500 |
|---|----------------|------------|-------------------|-------------|------------|
| 400 piece sample assortment of selected values from 33pF to 0.1µF | | | | | |
| Chip Size | Voltage Rating | Dielectric | Capacitance Range | Qty / Value | Total Qty |
| 0805 - 1812 | 500 VDC | NPO, X7R | 33pF to 0.1µF | 10-20 pcs | 400 pcs |

| 1000 VDC Ceramic Chip Capacitor Kit | | | | | P/N: S-1KV |
|---|----------------|------------|-------------------|-------------|------------|
| 400 piece sample assortment of selected values from 22pF to 0.1µF | | | | | |
| Chip Size | Voltage Rating | Dielectric | Capacitance Range | Qty / Value | Total Qty |
| 0805 - 2225 | 1000 VDC | NPO, X7R | 22pF to 0.1µF | 10-20 pcs | 400 pcs |

| 2000 VDC Ceramic Chip Capacitor Kit | | | | | P/N: S-2KV |
|---|----------------|------------|-------------------|-------------|------------|
| 300 piece sample assortment of selected values from 22pF to 0.022µF | | | | | |
| Chip Size | Voltage Rating | Dielectric | Capacitance Range | Qty / Value | Total Qty |
| 1206 - 2225 | 2000 VDC | NPO, X7R | 22pF to 0.022µF | 10-20 pcs | 300 pcs |

| X2 SAFETY CERTIFIED Ceramic Chip Capacitor Kit | | | | | P/N: S-SY3 |
|---|-----------------|------------|-------------------|-------------|------------|
| 240 piece sample assortment of selected values from 10pF to 1500 pF | | | | | |
| Chip Size | Voltage Rating | Dielectric | Capacitance Range | Qty / Value | Total Qty |
| 1808 | 3KV DC / 250 AC | NPO, X7R | 10pF to 1500 pF | 20 pcs | 240 pcs |

| X1/Y2 SAFETY CERTIFIED Ceramic Chip Capacitor Kit | | | | | P/N: S-SY2 |
|---|------------------|------------|-------------------|-------------|------------|
| 200 piece sample assortment of selected values from 10pF to 2200 pF | | | | | |
| Chip Size | Voltage Rating | Dielectric | Capacitance Range | Qty / Value | Total Qty |
| 1808 - 2220 | 5KV DC / 250 VAC | NPO, X7R | 10pF to 2200pF | 20 pcs | 200 pcs |

*Johanson may from time-time adjust actual kit contents based on design demand trends.
Check the Johanson web site for design kit updates and kit content changes.*



| EMI FILTER Capacitor Kit - 0402 Size | | | | | P/N: S-X07CBK |
|---|----------------|------------|-------------------|-------------|---------------|
| 600 piece sample assortment of selected values from 1.0pF to 0.01μF | | | | | |
| Chip Size | Voltage Rating | Dielectric | Capacitance Range | Qty / Value | Total Qty |
| 0402 | 10 - 50 VDC | NP0, X7R | 1.0pF to 0.01μF | 50 pcs | 600 pcs |

| EMI FILTER Capacitor Kit - 0603 Size | | | | | P/N: S-X14CBK |
|---|----------------|------------|-------------------|-------------|---------------|
| 700 piece sample assortment of selected values from 1.0pF to 0.01μF | | | | | |
| Chip Size | Voltage Rating | Dielectric | Capacitance Range | Qty / Value | Total Qty |
| 0603 | 50 - 100 VDC | NP0, X7R | 1.0pF to 0.01μF | 50 pcs | 700 pcs |

| POWER BYPASS Capacitor Kit - 0603 Size | | | | | P/N: S-X14-PBP |
|---|----------------|------------|-------------------|-------------|----------------|
| 300 piece sample assortment of selected values from 0.47nF to 0.220μF | | | | | |
| Chip Size | Voltage Rating | Dielectric | Capacitance Range | Qty / Value | Total Qty |
| 0603 | 6.3 - 100 VDC | X7R, X5R | 0.47nF to 0.22μF | 20 pcs | 300 pcs |

| EMI FILTER Capacitor Kit - 0805 Size | | | | | P/N: S-X15-EMI |
|---|----------------|------------|-------------------|-------------|----------------|
| 260 piece sample assortment of selected values from 1.0pF to 0.01μF | | | | | |
| Chip Size | Voltage Rating | Dielectric | Capacitance Range | Qty / Value | Total Qty |
| 0805 | 50 - 100 VDC | NP0, X7R | 1.0pF to 0.01μF | 20 pcs | 260 pcs |

| AUTOMOTIVE QUALIFIED capacitor kit | | | | | P/N: S-X2Y-AEC |
|---|----------------|------------|-------------------|-------------|----------------|
| 420 piece sample assortment of selected values from 100pF to 0.22μF | | | | | |
| Chip Size | Voltage Rating | Dielectric | Capacitance Range | Qty / Value | Total Qty |
| 0603, 0805, 1206 | 10 - 100 VDC | X7R | 100pF to 0.22μF | 30 pcs | 420 pcs |

*Johanson may from time-time adjust actual kit contents based on design demand trends.
Check the Johanson web site for design kit updates and kit content changes.*



HIGH VOLTAGE SURFACE MOUNT MLCCs 250 - 6,000 VDC



These high voltage capacitors feature a special internal electrode design which reduces voltage concentrations by distributing voltage gradients throughout the entire capacitor.

This unique design also affords increased capacitance values in a given case size and voltage rating. The capacitors are designed and manufactured to the general requirement of EIA198 and are subjected to a 100% electrical testing making them well suited for a wide variety of telecommunication, commercial, and industrial applications.

APPLICATIONS

- Analog & Digital Modems
- LAN/WAN Interface
- Lighting Ballast Circuits
- Voltage Multipliers
- DC-DC Converters
- Back-lighting Inverters

Polyterm® soft termination option for demanding environments & processes available on select parts, please contact the factory.

CASE SIZE

CAPACITANCE SELECTION

| JDI / EIA | INCHES | (MM) | RATED VOLTAGE | NP0 DIELECTRIC | | X7R DIELECTRIC | | |
|----------------------|--------|------------|---------------|----------------|---------|----------------|---------|----------|
| | | | | MINIMUM | MAXIMUM | MINIMUM | MAXIMUM | |
| R15/0805 ■ | L | .080 ±.010 | (2.03 ±.25) | 250 VDC | - | - | 1000 pF | 0.022 µF |
| | W | .050 ±.010 | (1.27 ±.25) | 500 VDC | 10 pF | 680 pF | 1000 pF | 0.010 µF |
| | T | .055 Max. | (1.40) | 630 VDC | 10 pF | 560 pF | 1000 pF | 6800 pF |
| | E/B | .020 ±.010 | (0.51±.25) | 1000 VDC | 10 pF | 390 pF | 100 pF | 2700 pF |
| | | | | 250 VDC | - | - | 1000 pF | 0.068 µF |
| R18/1206 ■ | L | .125 ±.010 | (3.18 ±.25) | 500 VDC | 10 pF | 1500 pF | 1000 pF | 0.033 µF |
| | W | .062 ±.010 | (1.57 ±.25) | 630 VDC | 10 pF | 1200 pF | 1000 pF | 0.027 µF |
| | T | .067 Max. | (1.70) | 1000 VDC | 10 pF | 1000 pF | 100 pF | 0.010 µF |
| | E/B | .020 ±.010 | (0.51±.25) | 2000 VDC | 10 pF | 220 pF | 100 pF | 4700 pF |
| | | | | 3000 VDC | 10 pF | 82 pF | 100 pF | 1000 pF |
| | | | | 250 VDC | - | - | 1000 pF | 0.150 µF |
| S41/1210 ■ | L | .125 ±.010 | (3.18 ±.25) | 500 VDC | 10 pF | 3900 pF | 1000 pF | 0.068 µF |
| | W | .095 ±.010 | (2.41 ±.25) | 630 VDC | 10 pF | 2700 pF | 1000 pF | 0.047 µF |
| | T | .080 Max. | (2.03) | 1000 VDC | 10 pF | 1800 pF | 100 pF | 0.015 µF |
| | E/B | .020 ±.010 | (0.51±.25) | 2000 VDC | 10 pF | 560 pF | 100 pF | 4700 pF |
| | | | | 3000 VDC | 10 pF | 220 pF | 100 pF | 1000 pF |
| | | | | 500 VDC | 10 pF | 4700 pF | 1000 pF | 0.100 µF |
| R29/1808 ■ | L | .185 ±.020 | (4.70 ±.51) | 630 VDC | 10 pF | 3300 pF | 1000 pF | 0.047 µF |
| | W | .080 ±.010 | (2.03 ±.25) | 1000 VDC | 1.0 pF | 2200 pF | 100 pF | 0.022 µF |
| | T | .085 Max. | (2.16) | 2000 VDC | 1.0 pF | 820 pF | 100 pF | 0.010 µF |
| | E/B | .020 ±.010 | (0.51±.25) | 3000 VDC | 1.0 pF | 470 pF | 100 pF | 3300 pF |
| | | | | 4000 VDC | 1.0 pF | 180 pF | 100 pF | 1800 pF |
| | | | | 5000 VDC | 1.0 pF | 75 pF | 47 pF | 390 pF |
| | | | | 6000 VDC | 1.0 pF | 75 pF | 47 pF | 150 pF |





Available cap. values include these significant retma values and their multiples: 1.0 1.2 1.5 1.8 2.2 2.7 3.3 3.9 4.7 5.6 6.8 8.2 (1.0 = 1.0, 10, 100, 1000, etc.) Consult factory for non-retma values and sizes or voltages not shown.



HIGH VOLTAGE SURFACE MOUNT MLCCs 250 - 6,000 VDC

CASE SIZE

CAPACITANCE SELECTION

| JDI / EIA | INCHES | (MM) | RATED VOLTAGE | NP0 DIELECTRIC | | X7R DIELECTRIC | | | | | | |
|--|--------------------|---|--|--|--------------------|---|--|----------|---------|----------|---------|----------|
| | | | | MINIMUM | MAXIMUM | MINIMUM | MAXIMUM | | | | | |
| S43 / 1812  | L W T E/B | .177 ±.012 .125 ±.010 .110 Max. .025 ±.015 | (4.50 ±.30) (3.18 ±.25) (2.80) (0.64±.38) | 250 VDC | - | - | 0.010 µF | 0.470 µF | | | | |
| | | | | 500 VDC | 100 pF | 8200 pF | 1000 pF | 0.330 µF | | | | |
| | | | | 630 VDC | 100 pF | 6800 pF | 1000 pF | 0.120 µF | | | | |
| | | | | 1000 VDC | 10 pF | 5600 pF | 1000 pF | 0.100 µF | | | | |
| | | | | 2000 VDC | 10 pF | 1800 pF | 100 pF | 0.010 µF | | | | |
| | | | | 3000 VDC | 10 pF | 1000 pF | 100 pF | 4700 pF | | | | |
| | | | | 4000 VDC | 10 pF | 390 pF | 100 pF | 1200 pF | | | | |
| | | | | 5000 VDC | 10 pF | 150 pF | 100 pF | 820 pF | | | | |
| | | | | 6000 VDC | 10 pF | 150 pF | 10 pF | 330 pF | | | | |
| | | | | S49 / 1825  | L W T E/B | .180 ±.010 .250 ±.010 .140 Max. .025 ±.015 | (4.57 ±.25) (6.35 ±.25) (3.56) (0.64±.38) | 500 VDC | 100 pF | 0.018 µF | 0.01 µF | 0.390 µF |
| 630 VDC | 100 pF | 0.015 µF | 0.01 µF | | | | | 0.270 µF | | | | |
| 1000 VDC | 10 pF | 0.012 µF | 1000 pF | | | | | 0.180 µF | | | | |
| 2000 VDC | 10 pF | 5600 pF | 100 pF | | | | | 0.039 µF | | | | |
| 3000 VDC | 10 pF | 2200 pF | 100 pF | | | | | 8200 pF | | | | |
| 4000 VDC | 10 pF | 1200 pF | 100 pF | | | | | 2200 pF | | | | |
| 5000 VDC | 10 pF | 390 pF | 100 pF | | | | | 1500 pF | | | | |
| 6000 VDC | 10 pF | 390 pF | 100 pF | | | | | 820 pF | | | | |
| S47 / 2220  | L W T E/B | .225 ±.015 .200 ±.015 .150 Max. .025 ±.015 | (5.72 ±.38) (5.08 ±.38) (3.81) (0.64±.38) | | | | | 500 VDC | 1000 pF | 0.018 µF | 0.01 µF | 0.470 µF |
| | | | | | | | | 630 VDC | 1000 pF | 0.018 µF | 0.01 µF | 0.270 µF |
| | | | | 1000 VDC | 100 pF | 0.015 µF | 1000 pF | 0.120 µF | | | | |
| | | | | 2000 VDC | 100 pF | 5600 pF | 1000 pF | 0.039 µF | | | | |
| | | | | 3000 VDC | 10 pF | 2700 pF | 100 pF | 0.010 µF | | | | |
| | | | | 4000 VDC | 10 pF | 1500 pF | 100 pF | 2700 pF | | | | |
| | | | | 5000 VDC | 10 pF | 470 pF | 100 pF | 1500 pF | | | | |
| | | | | 6000 VDC | 10 pF | 470 pF | 100 pF | 820 pF | | | | |
| | | | | S48 / 2225  | L W T E/B | .225 ±.010 .255 ±.015 .160 Max. .025 ±.015 | (5.72 ±.25) (6.48 ±.38) (4.06) (0.64±.38) | 500 VDC | 1000 pF | 0.027 µF | 0.01 µF | 0.560 µF |
| | | | | | | | | 630 VDC | 1000 pF | 0.022 µF | 0.01 µF | 0.390 µF |
| 1000 VDC | 100 pF | 0.018 µF | 1000 pF | | | | | 0.180 µF | | | | |
| 2000 VDC | 100 pF | 8200 pF | 1000 pF | | | | | 0.056 µF | | | | |
| 3000 VDC | 10 pF | 3300 pF | 100 pF | | | | | 0.012 µF | | | | |
| 4000 VDC | 10 pF | 1800 pF | 100 pF | | | | | 3300 pF | | | | |
| 5000 VDC | 10 pF | 470 pF | 100 pF | | | | | 2700 pF | | | | |
| 6000 VDC | 10 pF | 470 pF | 100 pF | | | | | 1200 pF | | | | |

Available cap. values include these significant retma values and their multiples: 1.0 1.2 1.5 1.8 2.2 2.7 3.3 3.9 4.7 5.6 6.8 8.2 (1.0 = 1.0, 10, 100, 1000, etc.) Consult factory for non-retma values and sizes or voltages not shown.

ELECTRICAL CHARACTERISTICS

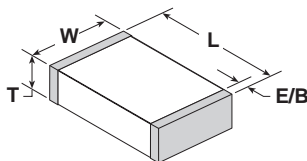

Meets the standard NP0 & X7R dielectric specifications listed on page 79

DIELECTRIC WITHSTANDING VOLTAGE DWV = 1.5 X rated WVDC for ratings 500-999 WVDC,
DWV = 1.2 X rated WVDC for ratings ≥ 1,000 WVDC

NOTE: Capacitors may require a surface coating to prevent external arcing. Solder mask should not be used beneath capacitors. For more information see JDI Tech Note "Surface Arc Season"

HOW TO ORDER HIGH VOLTAGE SURFACE MOUNT

P/N written: 202R18W102KV4E

| 202 | R18 | W | 102 | K | V | 4 | E |
|--|--|--------------------|--|------------------------------------|--|------------------------------|--|
| VOLTAGE | SIZE | DIELECTRIC | CAPACITANCE | TOLERANCE | TERMINATION | MARKING | PACKING |
| 501 = 500 V 631 = 630 V 102 = 1000 V 202 = 2000 V 302 = 3000 V 402 = 4000 V 502 = 5000 V 602 = 6000 V | R15 = 0805 R18 = 1206 R29 = 1808 S41 = 1210 S43 = 1812 S47 = 2220 S48 = 2225 S49 = 1825 | N = NP0 W = X7R | 1st two digits are significant; third digit denotes number of zeros. 102 = 1000 pF 104 = 0.10 µF | J = ± 5% K = ± 10% M = ± 20% | V = Ni Barrier with 100% Sn Plating (Matte) F = Polyterm flexible termination T = SnPb | 4 = Unmarked 6 = EIA Code | E = Embossed 7" T = Punched 7" No code = bulk Tape specs. per EIA RS481 |



AC SAFETY CAPACITORS



Johanson Dielectrics Type SC ceramic chip capacitors are designed for AC voltage surge and lightning protection in line-to-ground interface applications in computer networks, modem, facsimile and other equipment.

Johanson's safety capacitor offering includes four different case sizes in NPO and X7R dielectric materials.

These devices are surface mount ready with barrier terminations and tape and reel packaging.

Information on capacitor safety ratings and certification details may be found below.

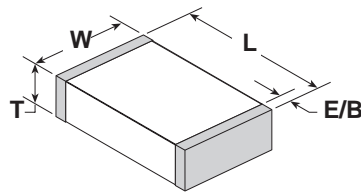

Polyterm® soft termination option for demanding environments & processes available on select parts, please contact the factory.

| SAFETY RATING | VOLTAGE RATING | WITHSTANDING VOLTAGE | IMPULSE VOLTAGE | CASE SIZE | JOHANSON ORDERING P/N |
|--|----------------|----------------------|-----------------|-----------|-----------------------|
| X2 | 250 VAC | 1,500 VAC | 2,500 V | 1808 | 302R29____V3E-****-SC |
| STANDARDS: IEC/EN 60384-14:2013+A1:2016 • UL 60384-14 CERTIFICATIONS: TUV T 72210484 • UL File E472557 & E212609 | | | | | |
| X2 | 250 VAC | 1,500 VAC | 2,500 V | 1812 | 302S43____V3E-****-SC |
| STANDARDS: IEC/EN 60384-14:2013+A1:2016 • UL 60384-14 CERTIFICATIONS: TUV T 72210484 • UL File E472557 & E212609 | | | | | |
| X1/Y2 | 250 VAC | 1,500 VAC | 5,000 V | 1808 | 502R29____V3E-****-SC |
| STANDARDS: IEC/EN 60384-14:2013+A1:2016 • UL 60384-14 CERTIFICATIONS: TUV T 72210484 • UL File E472557 | | | | | |
| X1/Y2 | 250 VAC | 1,500 VAC | 5,000 V | 1812 | 502S43____V3E-****-SC |
| STANDARDS: IEC/EN 60384-14:2013+A1:2016 • UL 60384-14 CERTIFICATIONS: TUV T 72210484 • UL File E472557 | | | | | |
| X1/Y2 | 250 VAC | 1,500 VAC | 5,000 V | 2211 | 502R30____V3E-****-SC |
| STANDARDS: IEC/EN 60384-14:2013+A1:2016 • UL 60384-14 CERTIFICATIONS: TUV T 72210484 • UL File E472557 | | | | | |
| X1/Y2 | 250 VAC | 1,500 VAC | 5,000 V | 2220 | 502S47____V3E-****-SC |
| STANDARDS: IEC/EN 60384-14:2013+A1:2016 • UL 60384-14 CERTIFICATIONS: TUV T 72210484 • UL File E472557 | | | | | |

X Capacitors are defined as suitable for use in situations where failure of the capacitor would not lead to danger of electric shock.

Y Capacitors are defined as suitable for use in situations where failure of the capacitor could lead to danger of electric shock.

EMI® FILTER & DECOUPLING CAPACITORS

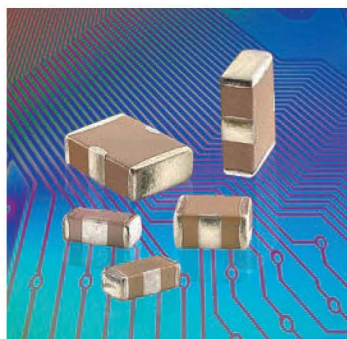

EMI® filter capacitors employ a unique, patented low inductance design featuring two balanced capacitors that are immune to temperature, voltage and aging performance differences. These components offer superior decoupling and EMI filtering performance, virtually eliminate parasitics, and can replace multiple capacitors and inductors saving board space and reducing assembly costs.

ADVANTAGES

- One device for EMI suppression or decoupling
- Replace up to 7 components with one EMI
- Differential and common mode attenuation
- Matched capacitance line to ground, both lines
- Low inductance due to cancellation effect

APPLICATIONS

- Amplifier Filter & Decoupling
- High Speed Data Filtering
- EMC I/O Filtering
- FPGA / ASIC / μ -P Decoupling
- DDR Memory Decoupling

Automotive version (AEC-Q200) available for many values: please see details in the below table of capacitance values. Please contact us if another value is needed for automotive application

| EMI Filtering (1 Y-Cap.) | | <10pF | 10pF | 22pF | 27pF | 33pF | 47pF | 100pF | 220pF | 470pF | 1000pF | 1500pF | 2200pF | 4700pF | .01 μ F | .015 μ F | .022 μ F | .039 μ F | .047 μ F | 0.10 μ F | 0.18 μ F | 0.22 μ F | 0.33 μ F | 0.40 μ F | 0.47 μ F | 1.0 μ F | |
|--------------------------|-----------|-------|------|------|------|------|------|-------|-------|-------|--------|--------|--------|--------|-------------|--------------|--------------|--------------|--------------|--------------|--------------|--------------|--------------|--------------|--------------|-------------|--|
| Power Bypass (2 Y-Caps.) | | <20pF | 20pF | 44pF | 54pF | 66pF | 94pF | 200pF | 440pF | 940pF | 2000pF | 3000pF | 4400pF | 9400pF | .02 μ F | .030 μ F | .044 μ F | .078 μ F | .094 μ F | 0.20 μ F | 0.36 μ F | 0.44 μ F | 0.66 μ F | 0.80 μ F | 0.94 μ F | 2.0 μ F | |
| SIZE | CAP. CODE | XR | 100 | 220 | 270 | 330 | 470 | 101 | 221 | 471 | 102 | 152 | 222 | 472 | 103 | 153 | 223 | 393 | 473 | 104 | 184 | 224 | 334 | 404 | 474 | 105 | |
| 0402 (X07) | NP0 | 50 | 50 | 50 | 50 | 50 | 50 | 50 | | | | | | | | | | | | | | | | | | | |
| | X7R | | | | | | | | 50 | 50 | 50 | 50 | 50 | 50 | 16 | | | | | | | | | | | | |
| 0603 (X14) | NP0 | 100 | 100 | 100 | 100 | 100 | 100 | 50 | 50 | | | | | | | | | | | | | | | | | | |
| | X7R | | | | | | 100 | 100 | 100 | 100 | 100 | 100 | 100 | 100 | 50 | 25 | 25 | | 16 | 10 | | 10 | | | | | |
| 0805 (X15) | NP0 | | 100 | 100 | 100 | 100 | 100 | 100 | 100 | 50 | | | | | | | | | | | | | | | | | |
| | X7R | | | | | | 100 | 100 | 100 | 100 | 100 | 100 | 100 | 100 | 50 | 50 | | 50 | 25 | | | | | | | | |
| 1206 (X18) | NP0 | | | | | | | | | | 100 | | | | | | | | | | | | | | | | |
| | X7R | | | | | | | | | | | | | | 100 | 100 | 100 | | 100 | 100* | | 16 | 16 | | 10 | | |
| 1210 (X41) | X7R | | | | | | | | | | | | | | 500 | | | | | 100 | | 100 | 100 | | 25 | 16 | |
| 1410 (X44) | X7R | | | | | | | | | | | | | | | 500 | | | | | | | | 100 | | | |
| 1812 (X43) | X7R | | | | | | | | | | | | | | | | | 500 | | | | | | | 100 | | |

□ Automotive version currently available for those values only

* Also proposed with a 50V rating (500X18W104MV4E) instead of 100V

Contact factory for part combinations not shown.

Filtering capacitance is specified as Line-to-Ground (Terminal A or B to G)

Power Bypass capacitance is specified Power-to-Ground (A + B to G)

Rated voltage is from line to ground in Circuit 1, power to ground in Circuit 2 .

HOW TO ORDER EMI® CAPACITORS

P/N written: 101X14W102MV4T

| 100 | X14 | W | 102 | M | V | 4 | T | +AQ |
|---|--|--------------------|---|--|---|------------------------------|--|-------------------------------------|
| VOLTAGE | SIZE | DIELECTRIC | CAPACITANCE | TOLERANCE | TERMINATION | MARKING | PACKING | QUALIFICATION |
| 6R3 = 6.3 V 100 = 10 V 160 = 16 V 250 = 25 V 500 = 50 V 101 = 100 V 501 = 500 V | X07 = 0402 X14 = 0603 X15 = 0805 X18 = 1206 X41 = 1210 X44 = 1410 X43 = 1812 | N = NP0 W = X7R | 1st two digits are significant; third digit denotes number of zeros, R = decimal. 102 = 1000 pF 104 = 0.10 μ F 5R6 = 5.6pF | M = \pm 20% * D = \pm 0.50 pF *Values < 10 pF only | V = NI Barrier with 100% Tin Plating (Matte) F = Polyterm flexible termination T = SnPb | 4 = Unmarked (Not available) | E = Embossed 7" T = Punched 7" No code = bulk Tape specs. per EIA RS481 | AEC-Q200 Qualification * (optional) |



EMI Filtering Scc21

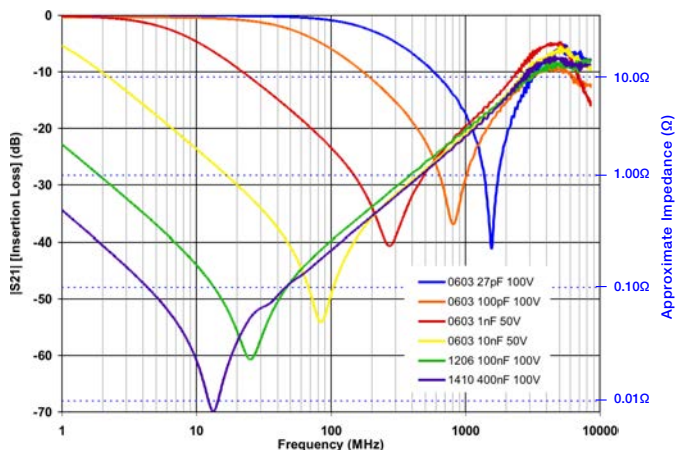
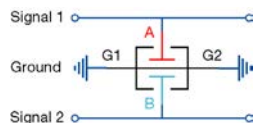

Power Bypass S21

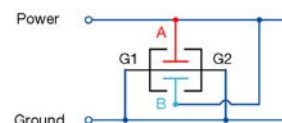

Labeled capacitance values below follow the P/N order code (single Y cap value)
Effective capacitance measured in Circuit 2 is 2X of the labeled single Y cap value.

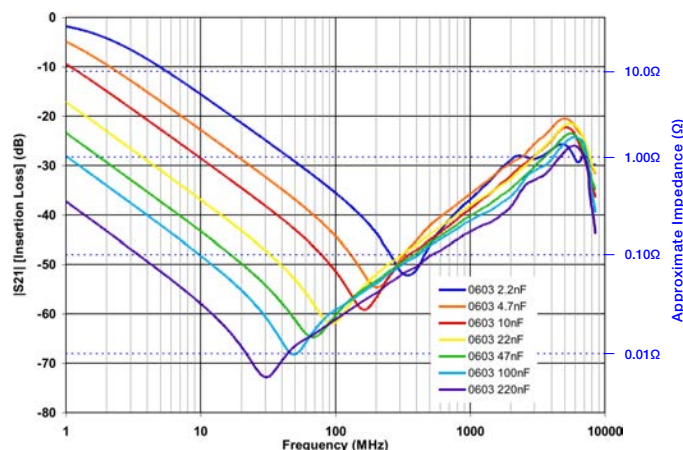

More data at <https://s21plotter.johansondielectrics.com/>

ELECTRICAL CHARACTERISTICS

| | NP0 | X7R |
|---|---|---|
| TEMPERATURE COEFFICIENT: | 0±30ppm/°C (-55 to +125°C) | ±15% (-55 to +125°C) |
| DIELECTRIC STRENGTH: | Vrated ≤100VDC: DWV = 2.5 X WVDC, 25°C, 50mA max. Vrated = 500VDC: DWV = 1.5 X WVDC, 25°C, 50mA max. | |
| DISSIPATION FACTOR: | 0.1% max. | WVDC ≥ 50 VDC: 2.5% max. WVDC = 25 VDC: 3.5% max. WVDC = 10-16 VDC: 5.0% max. WVDC = 6.3 VDC: 10% max. |
| INSULATION RESISTANCE (MIN. @ 25°C, WVDC) | C ≤ 0.047μF: 1000 ΩF or 100 GΩ, whichever is less C > 0.047μF: 500 ΩF or 10 GΩ, whichever is less | |
| TEST CONDITIONS: | C > 100 pF; 1kHz ±50Hz; 1.0±0.2 VRMS C ≤ 100 pF; 1Mhz ±50kHz; 1.0±0.2 VRMS | 1.0kHz±50Hz @ 1.0±0.2 Vrms |
| OTHER: | See page 81 for additional dielectric specifications. | |

Cross-sectional View

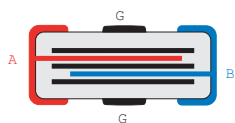

Dimensional View

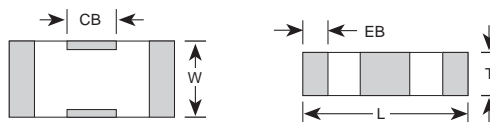

CASE SIZE

| | 0402 (X07) | | 0603 (X14) | | 0805 (X15) | | 1206 (X18) | | 1210 (X41) | | 1410 (X44) | | 1812 (X43) | |
|----|---------------|---------------|---------------|---------------|---------------|---------------|---------------|---------------|---------------|---------------|---------------|---------------|---------------|---------------|
| | IN | MM | IN | MM | IN | MM | IN | MM | IN | MM | IN | MM | IN | MM |
| L | 0.045 ± 0.003 | 1.143 ± 0.076 | 0.064 ± 0.005 | 1.626 ± 0.127 | 0.080 ± 0.008 | 2.032 ± 0.203 | 0.124 ± 0.010 | 3.150 ± 0.254 | 0.125 ± 0.010 | 3.175 ± 0.254 | 0.140 ± 0.010 | 3.556 ± 0.254 | 0.174 ± 0.010 | 4.420 ± 0.254 |
| W | 0.025 ± 0.003 | 0.635 ± 0.076 | 0.035 ± 0.005 | 0.889 ± 0.127 | 0.050 ± 0.008 | 1.270 ± 0.203 | 0.063 ± 0.010 | 1.600 ± 0.254 | 0.098 ± 0.010 | 2.489 ± 0.254 | 0.098 ± 0.010 | 2.490 ± 0.254 | 0.125 ± 0.010 | 3.175 ± 0.254 |
| T | 0.020 max | 0.508 max | 0.026 max | 0.660 max | 0.040 max | 1.016 max | 0.050 max | 1.270 max | 0.070 max | 1.778 max | 0.070 max | 1.778 max | 0.090 max | 2.286 max |
| EB | 0.008 ± 0.003 | 0.203 ± 0.076 | 0.010 ± 0.006 | 0.254 ± 0.152 | 0.012 ± 0.008 | 0.305 ± 0.203 | 0.016 ± 0.010 | 0.406 ± 0.254 | 0.018 ± 0.010 | 0.457 ± 0.254 | 0.018 ± 0.010 | 0.457 ± 0.254 | 0.022 ± 0.012 | 0.559 ± 0.305 |
| CB | 0.012 ± 0.003 | 0.305 ± 0.076 | 0.018 ± 0.004 | 0.457 ± 0.102 | 0.022 ± 0.005 | 0.559 ± 0.127 | 0.040 ± 0.005 | 1.016 ± 0.127 | 0.045 ± 0.005 | 1.143 ± 0.127 | 0.045 ± 0.005 | 1.143 ± 0.127 | 0.045 ± 0.005 | 1.143 ± 0.127 |



EMI FILTER & DECOUPLING CAPACITORS

THE EMI DESIGN - A BALANCED, LOW ESL, "CAPACITOR CIRCUIT"

The EMI capacitor design starts with standard 2 terminal MLC capacitor's opposing electrode sets, A & B, and adds a third electrode set (G) which surround each A & B electrode. The result is a highly versatile three node capacitive circuit containing two tightly matched, low inductance capacitors in a compact, four-terminal SMT chip.

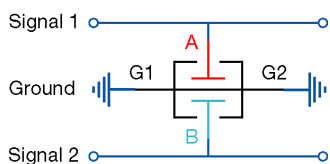
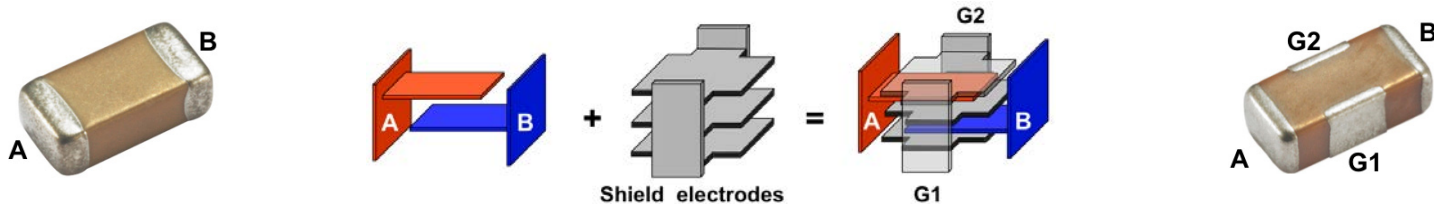

EMI FILTERING:

The EMI component contains two shunt or "line-to-ground" Y capacitors. Ultra-low ESL (equivalent series inductance) and tightly matched inductance of these capacitors provides unequalled high frequency Common-Mode noise filtering with low noise mode conversion. EMI components reduce EMI emissions far better than unbalanced discrete shunt capacitors or series inductive filters. Differential signal loss is determined by the cut off frequency of the single line-to-ground (Y) capacitor value of an EMI.

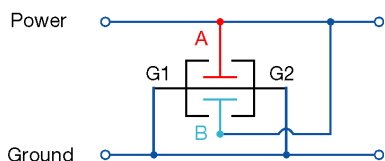

POWER BYPASS / DECOUPLING

For Power Bypass applications, EMI's two "Y" capacitors are connected in parallel. This doubles the total capacitance and reduces their mounted inductance by 80% or 1/5th the mounted inductance of similar sized MLC capacitors enabling high-performance bypass networks with far fewer components and vias. Low ESL delivers improved High Frequency performance into the GHz range.

GSM RFI ATTENUATION IN AUDIO & ANALOG

GSM handsets transmit in the 850 and 1850 MHz bands using a TDMA pulse rate of 217Hz. These signals cause the GSM buzz heard in a wide range of audio products from headphones to concert hall PA systems or "silent" signal errors created in medical, industrial process control, and security applications. Testing was conducted where an 840MHz GSM handset signal was delivered to the inputs of three different amplifier test circuit configurations shown below whose outputs were measured on a HF spectrum analyzer.

- 1) No input filter, 2 discrete MLC 100nF power bypass caps.
- 2) 2 discrete MLC 1nF input filter, 2 discrete MLC 100nF power bypass caps.
- 3) A single EMI 1nF input filter, a single EMI 100nF power bypass cap.

EMI configuration provided a nearly flat response above the ambient and up to 10 dB improved rejection than the conventional MLCC configuration.

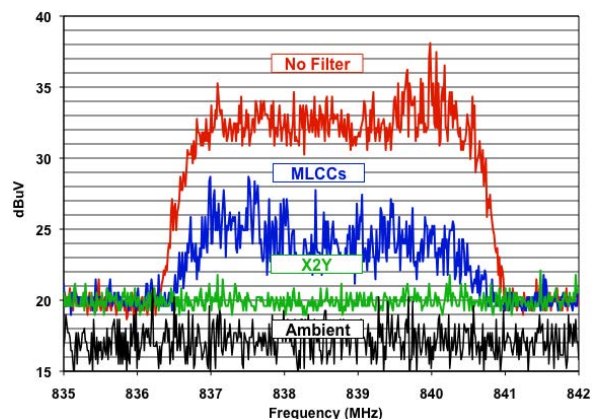

AMPLIFIER INPUT FILTER EXAMPLE

In this example, a single Johanson EMI component was used to filter noise at the input of a DC instrumentation amplifier. This reduced component count by 3-to-1 and costs by over 70% vs. conventional filter components that included 1% film Y-capacitors.

| Parameter | EMI 10nF | Discrete 10nF, 2 @ 220 pF | Comments |
|-----------------------|---------------|---------------------------|-------------------|
| DC offset shift | < 0.1 μ V | < 0.1 μ V | Referred to input |
| Common mode rejection | 91 dB | 92 dB | |

Source: Analog Devices, "A Designer's Guide to Instrumentation Amplifiers (2nd Edition)" by Charles Kitchin and Lew Counts

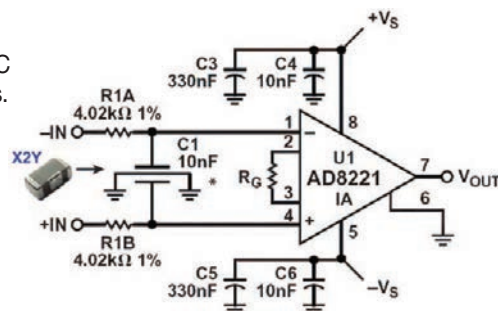

COMMON MODE CHOKE REPLACEMENT

- Superior High Frequency Emissions Reduction
 - Smaller Sizes, Lighter Weight
 - No Current Limitation
 - Vibration Resistant
 - No Saturation Concerns
- See our website for a detailed application note with component test comparisons and circuit emissions measurements.

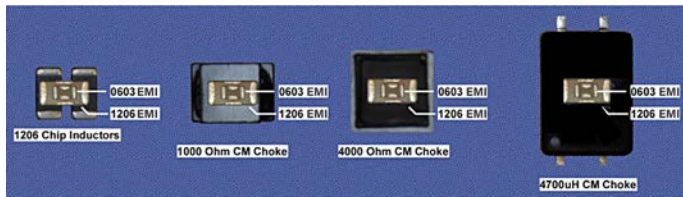

Measured Common Mode Rejection

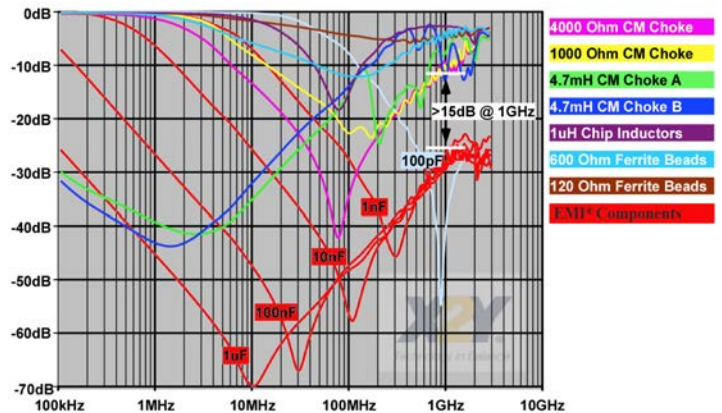

PARALLEL CAPACITOR SOLUTION

A common design practice is to parallel decade capacitance values to extend the high frequency performance of the filter network. This causes an unintended and often over-looked effect of anti-resonant peaks in the filter networks combined impedance. EMI's very low mounted inductance allows designers to use a single, higher value part and completely avoid the anti-resonance problem. The impedance graph on right shows the combined impedance of a 1nF, 10nF & 100nF MLC in parallel in RED. The MLC networks anti-resonance peaks are nearly 10 times the desired impedance. A 100nF and 47nF EMI are plotted in BLUE and GREEN. (The total capacitance of EMI (Circuit 2) is twice the value, or 200nF and 98nF in this example.) The single EMI is clearly superior to the three paralleled MLCs.



EMI HIGH PERFORMANCE POWER BYPASS - IMPROVE PERFORMANCE, REDUCE SPACE & VIAS

Actual measured performance of two high performance SerDes FPGA designs demonstrate how a 13 component EMI bypass network significantly out performs a 38 component MLC network.

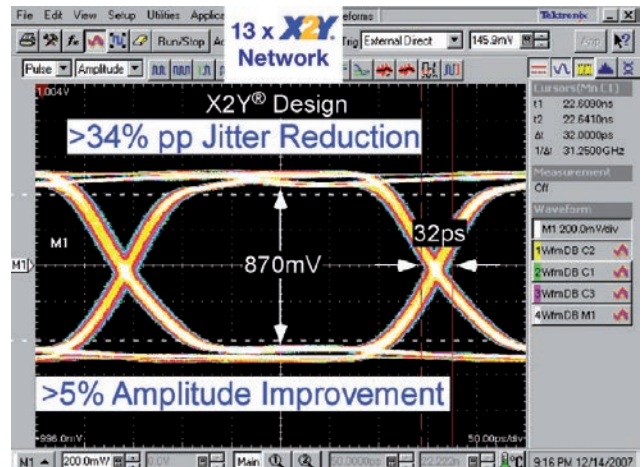
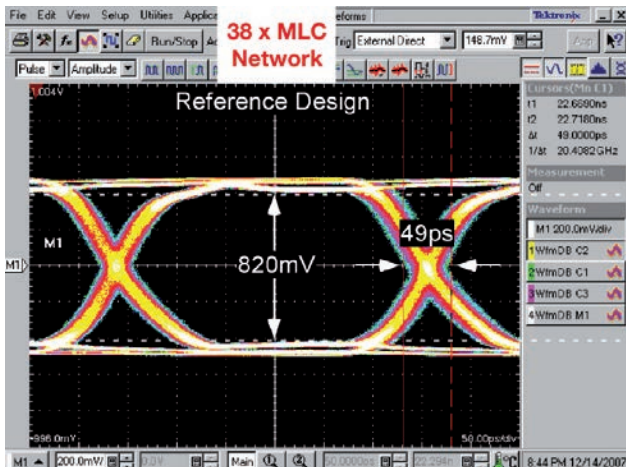
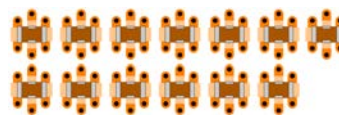
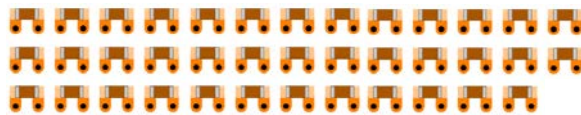

HIGH TEMPERATURE SURFACE MOUNT MLCCs 200°C



Johanson's high temperature MLCC series exhibit stable performance across an extended operating temperature range of -55°C to +200°C. Both Class I and Class II parts are available with DC voltage ratings of 50, 100 and 200V satisfying a wide range of demanding applications.

FEATURES

- Stable 200°C Operation
- Compact SMD Chip
- Polyterm® Termination Option
- Sn-Pb Termination Option

APPLICATIONS

- Deep Hole Drilling Electronics
- High Temperature Modules
- Industrial Equipment
- Automotive • Avionics

ELECTRICAL CHARACTERISTICS

| | NP0 | X7R |
|--------------------------|---|---------------------|
| OPERATING RANGE: | -55 to +200°C | -55 to +200°C |
| TEMPERATURE COEFFICIENT: | 0±30ppm/°C (-55to+125°C) | 0±15% (-55to+125°C) |
| 200°C CAP. DROP: | -0.5% max. | -45% max. |
| DISSIPATION FACTOR: | 0.001 (0.1%) max. | 0.020 (2.0%) max. |
| AGING RATE: | None | <1.0% per decade |
| INSULATION RESISTANCE: | 25°C IR >100GΩ or 1000ΩF (whichever is less) | |
| WITHSTANDING VOLTAGE: | 2.5 X WVDC for ratings ≤ 200 VDC 1.5 X WVDC for ratings 201-500 VDC | |
| TEST CONDITIONS: | C > 100 pF; 1kHz ±50Hz; 1.0±0.2 VRMS C ≤ 100 pF; 1Mhz ±50kHz; 1.0±0.2 VRMS | |

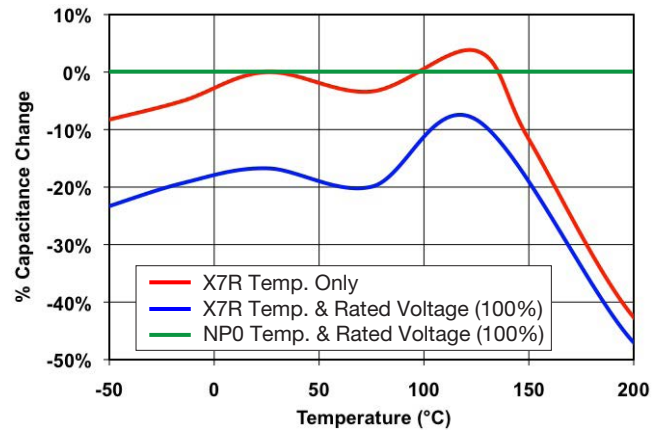





MECHANICAL CHARACTERISTICS

| | | | RATED VOLTAGE | NP0 DIELECTRIC | | X7R DIELECTRIC | |
|----------|-----|------------------------|---------------|----------------|---------|----------------|----------|
| | | | | MINIMUM | MAXIMUM | MINIMUM | MAXIMUM |
| T07/0402 | L | Inches (mm) | 25 VDC | 10 pF | 270 pF | 100 pF | 4700 pF |
| | W | .040 ±.004 (1.02 ±.10) | 50 VDC | 10 pF | 120 pF | 100 pF | 1500 pF |
| | T | .020 ±.004 (0.51 ±.10) | 100 VDC | 10 pF | 82 pF | 10 pF | 390 pF |
| | E/B | .025 Max. (0.64) | 200 VDC | 10 pF | 50 pF | 10 pF | 100 pF |
| T14/0603 | L | Inches (mm) | 25 VDC | 10 pF | 820 pF | 1000 pF | 0.022 μF |
| | W | .063 ±.008 (1.60 ±.20) | 50 VDC | 10 pF | 330 pF | 1000 pF | 0.010 μF |
| | T | .032 ±.008 (0.81 ±.20) | 100 VDC | 10 pF | 220 pF | 100 pF | 2200 pF |
| | E/B | .035 Max. (0.89) | 200 VDC | 10 pF | 120 pF | 100 pF | 560 pF |
| T15/0805 | L | Inches (mm) | 25 VDC | 100 pF | 2200 pF | 1000 pF | 0.100 μF |
| | W | .080 ±.010 (2.03 ±.25) | 50 VDC | 100 pF | 1500 pF | 1000 pF | 0.033 μF |
| | T | .050 ±.010 (1.27 ±.25) | 100 VDC | 100 pF | 1000 pF | 1000 pF | 0.010 μF |
| | E/B | .055 Max. (1.40) | 200 VDC | 10 pF | 680 pF | 100 pF | 2200 pF |

HIGH TEMPERATURE SURFACE MOUNT MLCCs 200°C

MECHANICAL CHARACTERISTICS

| | | | | RATED VOLTAGE | NP0 DIELECTRIC | | X7R DIELECTRIC | |
|--|-----|------------|-------------|---------------|----------------|----------|----------------|----------|
| | | | | | MINIMUM | MAXIMUM | MINIMUM | MAXIMUM |
| T18/1206  | | Inches | (mm) | 25 VDC | 100 pF | 6800 pF | 1000 pF | 0.220 μF |
| | L | .125 ±.010 | (3.17 ±.25) | 50 VDC | 100 pF | 3300 pF | 1000 pF | 0.100 μF |
| | W | .062 ±.010 | (1.57 ±.25) | 100 VDC | 100 pF | 2200 pF | 1000 pF | 0.022 μF |
| | T | .067 Max. | (1.70) | 200 VDC | 100 pF | 1500 pF | 1000 pF | 5600 pF |
| | E/B | .020±.010 | (0.51±.25) | | | | | |
| T41/1210  | | Inches | (mm) | 25 VDC | 1000 pF | 0.015 μF | 0.047 μF | 0.470 μF |
| | L | .125 ±.010 | (3.18 ±.25) | 50 VDC | 1000 pF | 5600 pF | 0.047 μF | 0.220 μF |
| | W | .095 ±.010 | (2.41 ±.25) | 100 VDC | 100 pF | 4700 pF | 0.047 μF | 0.056 μF |
| | T | .090 Max. | (2.28) | 200 VDC | 100 pF | 3300 pF | 0.0047 μF | 0.015 μF |
| | E/B | .020±.010 | (0.51±.25) | | | | | |
| T43/1812  | | Inches | (mm) | 25 VDC | 1000 pF | 0.033 μF | 0.047 μF | 1.000 μF |
| | L | .175 ±.010 | (4.45 ±.25) | 50 VDC | 1000 pF | 0.012 μF | 0.047 μF | 0.470 μF |
| | W | .125 ±.010 | (3.17 ±.25) | 100 VDC | 1000 pF | 0.010 μF | 0.047 μF | 0.180 μF |
| | T | .110 Max. | (2.80) | 200 VDC | 1000 pF | 8200 pF | 0.047 μF | 0.047 μF |
| | E/B | .025±.015 | (0.64±.38) | | | | | |
| T49/1825  | | Inches | (mm) | 25 VDC | 1000 pF | 0.033 μF | 0.10 μF | 2.200 μF |
| | L | .180 ±.010 | (4.57 ±.25) | 50 VDC | 1000 pF | 0.027 μF | 0.10 μF | 1.000 μF |
| | W | .250 ±.010 | (6.35 ±.25) | 100 VDC | 1000 pF | 0.022 μF | 0.10 μF | 0.560 μF |
| | T | .140 Max. | (3.56) | 200 VDC | 1000 pF | 0.018 μF | 0.10 μF | 0.150 μF |
| | E/B | .025±.015 | (0.64±.38) | | | | | |
| T48/2225  | | Inches | (mm) | 25 VDC | 1000 pF | 0.100 μF | 0.10 μF | 3.300 μF |
| | L | .225 ±.010 | (5.72 ±.25) | 50 VDC | 1000 pF | 0.039 μF | 0.10 μF | 1.500 μF |
| | W | .255 ±.015 | (6.48 ±.38) | 100 VDC | 1000 pF | 0.033 μF | 0.10 μF | 0.820 μF |
| | T | .160 Max. | (4.06) | 200 VDC | 1000 pF | 0.022 μF | 0.10 μF | 0.220 μF |
| | E/B | .025±.015 | (0.64±.38) | | | | | |

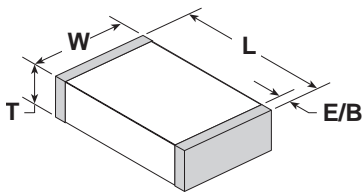

See page 81 for additional dielectric specifications.

HOW TO ORDER 200°C MLCCs

P/N written: 500T14W103KV4E

| 500 | T14 | W | 103 | K | V | 4 | E |
|--|--|--------------------|---|---|--|---------------------------------|---|
| VOLTAGE | SIZE | DIELECTRIC | CAPACITANCE | TOLERANCE | TERMINATION | MARKING | PACKING |
| 250 = 25 V 500 = 50 V 101 = 100 V 201 = 200 V | T07 = 0402 T14 = 0603 T15 = 0805 T18 = 1206 T41 = 1210 T43 = 1812 T49 = 1825 T48 = 2225 | N = NP0 W = X7R | 1st two digits are significant; third digit denotes number of zeros. 102 = 1000 pF 103 = 0.01 μF 104 = 0.10 μF | NP0 J = ± 5% K = ± 10% X7R K = ± 10% M = ± 20% | V = Ni Barrier w/ 100% Sn Plating (150°C) T = Ni Barrier w/ 95%Sn/5%Pb Plating (150°C) E = Ni Barrier w/ 100% Sn Plating (180°C) P = Palladium Silver Pd-Ag (200°C) | 4 = Unmarked (Not available) | E = Embossed 7" T = Punched 7" No code = bulk Tape specs. per EIA RS481 |



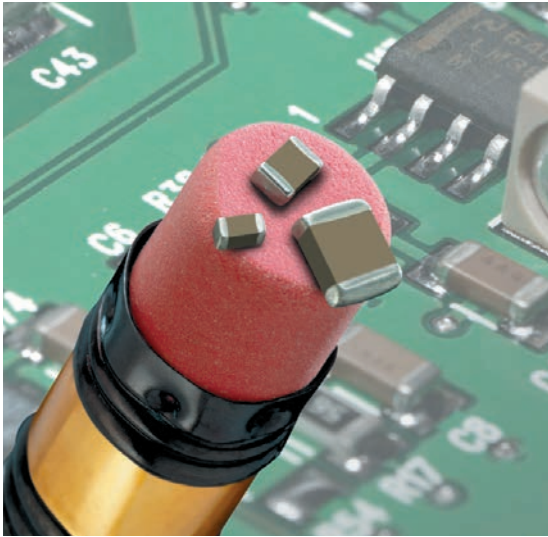

TANCERAM® chip capacitors can replace tantalum capacitors in many applications and offer several key advantages over traditional tantalums. Because TANCERAM® capacitors exhibit extremely low ESR, equivalent circuit performance can often be achieved using considerably lower capacitance values. Low DC leakage reduces current drain, extending the battery life of portable products. TANCERAM® high DC breakdown voltage ratings offer improved reliability and eliminate large voltage de-rating common when designing with tantalums.

ADVANTAGES

- Low ESR
- Higher Surge Voltage
- Reduced CHIP Size
- Higher Insulation Resistance
- Low DC Leakage
- Non-polarized Devices
- Improved Reliability
- Higher Ripple Current

APPLICATIONS

- Switching Power Supply Smoothing (Input/Output)
- DC/DC Converter Smoothing (Input/Output)
- Backlighting Inverters
- General Digital Circuits

Typical ESR Comparison

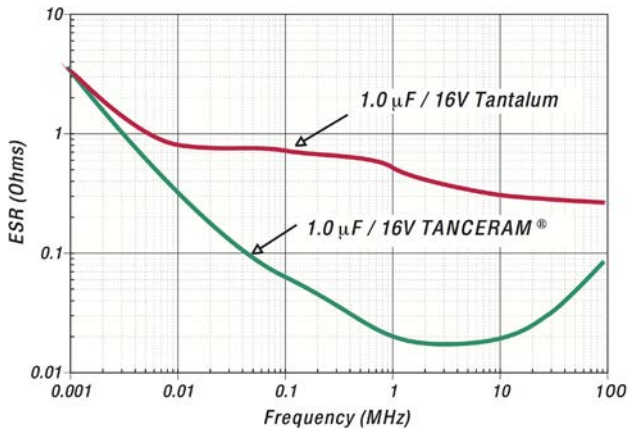

Typical Breakdown Voltage Comparison

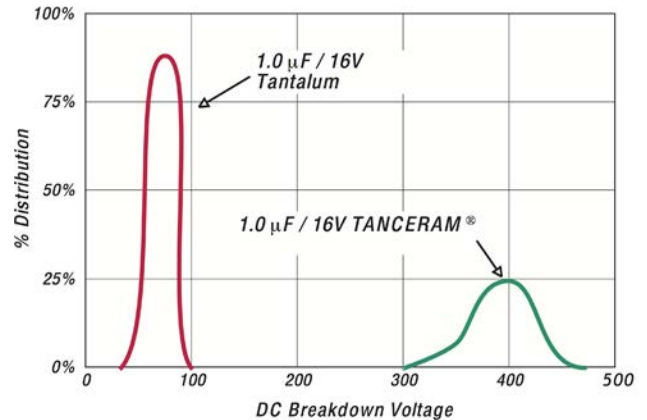

HOW TO ORDER TANCERAM®

Part number written: 100R15X106MV4E

| 100 | R15 | X | 106 | M | V | 4 | E |
|--|-------------|--------------------|--|----------------------|---|----------------|--|
| VOLTAGE | SIZE | DIELECTRIC | CAPACITANCE | TOLERANCE | TERMINATION | MARKING | PACKING |
| 6R3 = 6.3 V 100 = 10 V 160 = 16 V 250 = 25 V 500 = 50 V 101 = 100 V | See Chart | W = X7R X = X5R | 1st two digits are significant; third digit denotes number of zeros. 105 = 1.00 µF 476 = 47.0 µF 107 = 100 µF | K = ±10% M = ±20% | V = Nickel Barrier with 100% Tin Plating (Matte) T = SnPb* (*available on select parts) | 4 = Unmarked | Code Type Reel E Plastic 7" T Paper 7" Tape specifications conform to EIA RS481 |

CAPACITANCE SELECTION

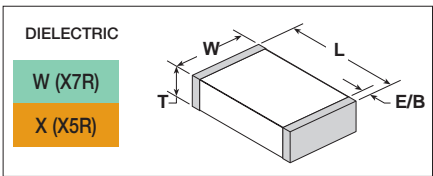

| EIA / JDI | INCHES | (mm) | VDC | 1.0 µF | 1.5 µF | 2.2 µF | 3.3 µF | 4.7 µF | 10 µF | 22 µF | 47 µF | 100 µF | 220 µF | |
|------------------|---|--|------------|--------|--------|--------|--------|--------|-------|-------|-------|--------|--------|--|
| 0201 R05 - | L .024 ±.001 W .011 ±.001 T .013 Max. EB .004 Min. | (0.60 ±.03) (0.28 ±.03) (0.33 Max.) (0.10 Min.) | Dielectric | W | X | W | X | W | X | W | X | W | X | |
| | | | 10 | | | | | | | | | | | |
| | | | 6.3 | | | | | | | | | | | |
| | | | 4 | | | | | | | | | | | |
| | | | 35 | | | | | | | | | | | |
| 0402 R07 - | L .039 ±.002 W .020 ±.002 T .022 Max. EB .002 Min. | (0.99 ±.05) (0.51 ±.05) (0.55 Max.) (0.05 Min.) | 35 | | | | | | | | | | | |
| | | | 25 | | | | | | | | | | | |
| | | | 16 | | | | | | | | | | | |
| | | | 10 | | | | | | | | | | | |
| | | | 6.3 | | | | | | | | | | | |
| 0603 R14 - | L .063 ±.004 W .031 ±.004 T .037 Max. EB .006 Min. | (1.60 ±.10) (0.79 ±.10) (0.93 Max.) (0.15 Min.) | 50 | | | | | | | | | | | |
| | | | 35 | | | | | | | | | | | |
| | | | 25 | | | | | | | | | | | |
| | | | 16 | | | | | | | | | | | |
| | | | 10 | | | | | | | | | | | |
| 0805 R15 - | L .079 ±.012 W .049 ±.008 T .057 Max. EB .008 Min. | (2.01 ±.30) (1.24 ±.20) (1.44 Max.) (0.20 Min.) | 50 | | | | | | | | | | | |
| | | | 35 | | | | | | | | | | | |
| | | | 25 | | | | | | | | | | | |
| | | | 16 | | | | | | | | | | | |
| | | | 10 | | | | | | | | | | | |
| 1206 R18 - | L .126 ±.012 W .063 ±.008 T .071 Max. EB .010 Min. | (3.20 ±.30) (1.60 ±.20) (1.80 Max.) (0.25 Min.) | 50 | | | | | | | | | | | |
| | | | 35 | | | | | | | | | | | |
| | | | 25 | | | | | | | | | | | |
| | | | 16 | | | | | | | | | | | |
| | | | 10 | | | | | | | | | | | |
| 1210 S41 - | L .126 ±.012 W .098 ±.012 T .106 Max. EB .012 Min. | (3.20 ±.30) (2.49 ±.30) (2.69 Max.) (0.30 Min.) | 50 | | | | | | | | | | | |
| | | | 35 | | | | | | | | | | | |
| | | | 25 | | | | | | | | | | | |
| | | | 16 | | | | | | | | | | | |
| | | | 10 | | | | | | | | | | | |
| 1812 S43 - | L .177 ±.016 W .126 ±.012 T .118 Max. EB .012 Min. | (4.50 ±.41) (3.20 ±.30) (2.99 Max.) (0.30 Min.) | 50 | | | | | | | | | | | |
| | | | 25 | | | | | | | | | | | |
| 2220 S47 - | L .220 ±.016 W .197 ±.016 T .118 Max. EB .012 Min. | (5.59 ±.41) (3.20 ±.30) (2.99 Max.) (0.30 Min.) | 50 | | | | | | | | | | | |
| | | | 25 | | | | | | | | | | | |

"K" OR "M" TOLERANCE, 0201 ONLY AVAILIABLE IN M ONLY "M" TOLERANCE

ELECTRICAL CHARACTERISTICS

| DIELECTRIC: | X7R | X5R |
|---|--|---|
| TEMPERATURE COEFFICIENT: | ±15% (-55 to +125°C) | ±15% (-55 to +85°C) |
| DISSIPATION FACTOR: | For ≥ 50 VDC: 5% max. For ≤ 35 VDC: 10% max. | For ≥ 50 VDC: 5% max. For ≤ 35 VDC: 10% max. |
| INSULATION RESISTANCE (MIN. @ 25°C, WVDC) | 100 ΩF or 10 GΩ, whichever is less | |
| DIELECTRIC STRENGTH: | 2.5 X WVDC, 25°C, 50mA max. | |
| TEST CONDITIONS: | Capacitance values ≤ 10 µF: 1.0kHz±50Hz @ 1.0±0.2 Vrms Capacitance values > 10 µF: 120Hz±10Hz @ 0.5V±0.1 Vrms | |
| OTHER: | See page 81 for additional dielectric specifications. | |



SURFACE MOUNT MLCCs 10 - 200 VDC

| CASE SIZE | | | Voltage | AVAILABLE CAPACITANCE CODE | | | | | | | | | | | | | | | | | | | | | | | | | |
|-----------|--------|--|---------|----------------------------|-----|-----|-----|-----|-----|-----|-----|-----|-----|-----|-----|-----|-----|-----|-----|-----|-----|-----|-----|-----|-----|-----|-----|-----|-----|
| JDI | Inches | (mm) | | 0R5 | XRX | 100 | 120 | 150 | 180 | 220 | 270 | 330 | 390 | 470 | 560 | 680 | 820 | 101 | 121 | 151 | 181 | 221 | 271 | 331 | 391 | 471 | 561 | 681 | 821 |
| R05 | 0201 | (0603) L .024 ±.001 W .012 ±.001 T .012 ±.001 EB .006 ±.002 (0.60 ±.03) (0.30 ±.03) (0.30 ±.03) (0.15±.05) | 25V | █ | | | | | | | | | | | | | | | | | | | | | | | | | |
| | | | 16V | █ | | | | | | | | | | | █ | | | | | | | | | | | | | | |
| | | | 10V | █ | | | | | | | | | | | █ | | | | | | | █ | | | | | | | |
| | | | 50V | █ | | | | | | | | | | | █ | | | | | | | | | | | | | | |
| R07 | 0402 | (1005) L .040 ±.004 W .020 ±.004 T .025 Max. EB .008 ±.004 (1.02 ±.10) (0.51 ±.10) (0.64) (0.20±.10) | 50V | █ | | | | | | | | | | | █ | | | | | | | | | | | | | | |
| | | | 25V | █ | | | | | | | | | | | █ | | | | | | | | | | | | | | |
| | | | 16V | █ | | | | | | | | | | | █ | | | | | | | | | | | | | | |
| | | | 10V | █ | | | | | | | | | | | █ | | | | | | | | | | | | | | |
| R14 | 0603 | (1608) L .063 ±.008 W .032 ±.008 T .035 Max. EB .010±.005 (1.60 ±.20) (0.81 ±.20) (0.89) (.25±.13) | 200V | █ | | | | | | | | | | | █ | | | | | | | | | | | | | | |
| | | | 100V | █ | | | | | | | | | | | █ | | | | | | | | | | | | | | |
| | | | 50V | █ | | | | | | | | | | | █ | | | | | | | | | | | | | | |
| | | | 25V | █ | | | | | | | | | | | █ | | | | | | | | | | | | | | |
| | | | 16V | █ | | | | | | | | | | | █ | | | | | | | | | | | | | | |
| R15 | 0805 | (2012) L .080 ±.010 W .050 ±.010 T .050 Max. EB .020±.010 (2.03 ±.25) (1.27 ±.25) (1.27) (0.51±.25) | 200V | █ | | | | | | | | | | | █ | | | | | | | | | | | | | | |
| | | | 100V | █ | | | | | | | | | | | █ | | | | | | | | | | | | | | |
| | | | 50V | █ | | | | | | | | | | | █ | | | | | | | | | | | | | | |
| | | | 25V | █ | | | | | | | | | | | █ | | | | | | | | | | | | | | |
| | | | 16V | █ | | | | | | | | | | | █ | | | | | | | | | | | | | | |
| R18 | 1206 | (3216) L .125 ±.010 W .062 ±.010 T .050 Max. EB .020 ±.010 (3.17 ±.25) (1.57 ±.25) (1.27) (0.51 ±.25) | 200V | █ | | | | | | | | | | | █ | | | | | | | | | | | | | | |
| | | | 100V | █ | | | | | | | | | | | █ | | | | | | | | | | | | | | |
| | | | 50V | █ | | | | | | | | | | | █ | | | | | | | | | | | | | | |
| | | | 25V | █ | | | | | | | | | | | █ | | | | | | | | | | | | | | |
| S41 | 1210 | (3224) L .125 ±.010 W .095 ±.010 T .065 Max. EB .020 ±.010 (3.18 ±.25) (2.41 ±.25) (1.65) (0.51 ±.25) | 200V | | | | | | | | | | | | NP0 | | | | | | | | | | | | | | |
| | | | 100V | | | | | | | | | | | | X7R | | | | | | | | | | | | | | |
| | | | 50V | | | | | | | | | | | | | | | | | | | | | | | | | | |
| | | | 25V | | | | | | | | | | | | | | | | | | | | | | | | | | |
| | | | 16V | | | | | | | | | | | | | | | | | | | | | | | | | | |
| S43 | 1812 | (4532) L .175 ±.010 W .125 ±.010 T .085 Max. EB .025 ±.015 (4.45 ±.25) (3.17 ±.25) (2.16) (0.64 ±.38) | 200V | | | | | | | | | | | | | | | | | | | | | | | | | | |
| | | | 100V | | | | | | | | | | | | | | | | | | | | | | | | | | |
| | | | 50V | | | | | | | | | | | | | | | | | | | | | | | | | | |
| | | | 25V | | | | | | | | | | | | | | | | | | | | | | | | | | |

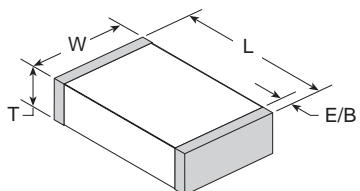

How To ORDER - SURFACE MOUNT MLCC

Part number written: 100R07W104KV4E

| | | | | | | | |
|--|--|-------------------------------|---|--|--|--|---|
| 100 | R 07 | W | 104 | K | V | 4 | E |
| VOLTAGE | SERIES/SIZE | DIELECTRIC | CAPACITANCE | TOLERANCE | TERMINATION | MARKING | PACKING |
| 100 = 10 V DC 160 = 16 V DC 250 = 25 V DC 500 = 50 V DC 101 = 100 V DC 201 = 200 V DC | R05 = 0201 R07 = 0402 R14 = 0603 R15 = 0805 R18 = 1206 S41 = 1210 S43 = 1812 | N = NP0 W = X7R X = X5R | 1st two digits are significant; third digit denotes number of zeros, R = decimal. 5R6 = 5.6 pF 100 = 10 pF 102 = 1,000 pF 474 = 0.47 μF | * B = ± 0.10 pF * C = ± 0.25 pF * D = ± 0.50 pF F = ± 1 % G = ± 2 % J = ± 5 % K = ± 10 % M = ± 20 % *Values < 10 pF only | V = Nickel Barrier with 100% Tin Plating (Matte) T = SnPb | 3 = Special 4 = Unmarked 6 = EIA Code* *Not available on sizes ≤ 0402 | E = Embossed 7" T = Punched 7" U = Embossed 13" R = Punched 13" No code = bulk Tape specifications on page 48. Not all tape styles are available on all parts. |



STACKED SMPS CERAMIC CAPACITORS



Stacked Switch-Mode ceramic capacitors feature large capacitance values and exhibit low ESR (equivalent series resistance) and low ESL (equivalent series inductance) making them well suited for high power and high frequency applications where tantalum or aluminum electrolytic capacitors may not be suitable. The P-Series feature mechanical and pin-out configurations per DSCC 87106 and 88011 drawings while the E-Series feature mechanical and pin-out configurations more common in European design applications.

KEY FEATURES

- P-Series Approved to DSCC Drawings 87106 & 88011 MIL-PRF-49470
- New T-Series 200°C for downhole tools and aircraft engine control applications.
- E-Series Common European Lead Styles available to MIL-PRF-49470 requirements.
- NP0 & X7R Dielectrics, 50 to 500 VDC Ratings
- Low ESR / Low ESL, Ideal for SMPS Filtering Applications
- Custom Sizes, Voltages, and Values Available

CASE SIZE

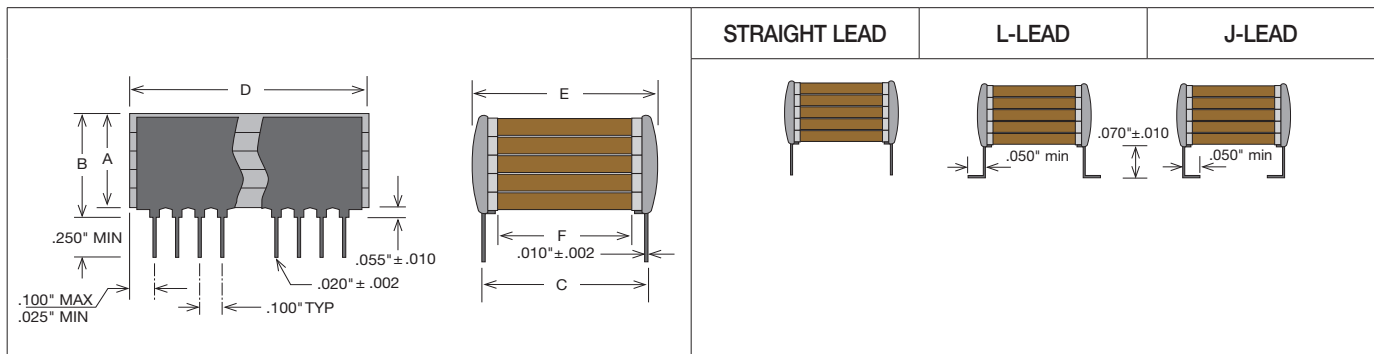

HOW TO ORDER STACKED SMPS

Part number written: 201P03W275KJ4H

| 201 | P03 | W | 275 | K | J | 4 | H |
|---|-------------|------------------------------|---|---|--|-------------------------------|---|
| VOLTAGE | SIZE | DIELECTRIC | CAPACITANCE | TOLERANCE | TERMINATION | MARKING | PACKING |
| 500 = 50 V 101 = 100 V 201 = 200 V 501 = 500 V | See Chart | N = NP0 B = BX W = X7R | 1st two digits are significant; third digit denotes number of zeros. 101 = 100 pF 102 = 1000 pF 103 = 0.01 μF 105 = 1.00 μF | J = ±5% K = ±10% L = ±15% M = ±20% N = ±30% Z = +80% -20% P = +100% -0% | J = "J" Leads (formed in) K = "J" Leads with reduced height of .045" ±.010" L = "L" Leads (formed out) M = "L" Leads with reduced height of .045" ±.010" N = Straight Lead | 4 = Standard 3 = Specified | T = Tape and Reel H = High Reliability testing per customer requirements S = Special Part |



STACKED SMPS CERAMIC CAPACITORS

P-SERIES DSCC STYLE X7R CAPACITANCE / VOLTAGE SELECTION

| CASE SIZE | CHIP LAYERS | LEADS /SIDE | MECHANICAL SIZE RANGE (IN.) | | | X7R MAX CAPACITANCE (µF) | | | |
|-----------|-------------|-------------|-----------------------------|-----------|----------|--------------------------|------|------|------|
| | | | LENGTH (D) | WIDTH (E) | TMAX (B) | 50V | 100V | 200V | 500V |
| P05 | 1 | 3 | 0.275 | 0.300 | .185 | 3.0 | 2.2 | 1.0 | 0.50 |
| P55 | 5 | | | | .715 | 15 | 11 | 5.0 | 2.5 |
| P04 | 1 | 4 | 0.425 | 0.440 | .185 | 9.0 | 6.5 | 3.0 | 1.5 |
| P54 | 5 | | | | .715 | 45 | 32 | 15 | 7.5 |
| P03 | 1 | 10 | 1.075 | 0.500 | .185 | 28 | 20 | 9.5 | 4.7 |
| P53 | 5 | | | | .715 | 140 | 100 | 47 | 23 |
| P01 | 1 | 20 | 2.075 | 0.500 | .185 | 50 | 40 | 19 | 9.4 |
| P51 | 5 | | | | .715 | 250 | 200 | 95 | 46 |
| P02 | 1 | 15 | 1.535 | 0.870 | .185 | 75 | 55 | 25 | 14 |
| P52 | 5 | | | | .715 | 370 | 270 | 125 | 70 |
| P06 | 1 | 20 | 2.075 | 1.350 | .185 | 160 | 110 | 50 | 25 |
| P56 | 5 | | | | .715 | 800 | 550 | 250 | 125 |

Please refer to our website for complete offering including NP0 & BX capacitance ranges.

NEW 200°C T-SERIES CAPACITANCE / VOLTAGE SELECTION

| CASE SIZE | CHIP LAYERS | LEADS /SIDE | MECHANICAL SIZE RANGE (IN.) | | | MAX CAPACITANCE (µF) | | |
|-----------|-------------|-------------|-----------------------------|-----------|----------|----------------------|------|------|
| | | | LENGTH (D) | WIDTH (E) | TMAX (B) | 50V | 100V | 200V |
| T05 | 1 | 3 | 0.275 | 0.300 | .185 | 1.20 | 0.68 | 0.33 |
| T55 | 5 | | | | .715 | 5.60 | 3.30 | 1.50 |
| T04 | 1 | 4 | 0.425 | 0.440 | .185 | 2.70 | 1.50 | 0.82 |
| T54 | 5 | | | | .715 | 15.0 | 8.20 | 3.90 |
| T03 | 1 | 10 | 1.075 | 0.500 | .185 | 10.0 | 5.60 | 2.70 |
| T53 | 5 | | | | .715 | 47.0 | 27.0 | 12.0 |

Please refer to our website for complete offering including NP0 capacitance ranges.
or contact our technical team @ <https://johansondielectrics.com/ask-a-question>

E-SERIES EUROPEAN STYLE X7R CAPACITANCE / VOLTAGE SELECTION

| CASE SIZE | CHIP LAYERS | LEADS /SIDE | MECHANICAL SIZE RANGE (MM) | | | X7R MAX CAPACITANCE (µF) | | | |
|-----------|-------------|-------------|----------------------------|-----------|----------|--------------------------|------|------|------|
| | | | LENGTH (D) | WIDTH (E) | TMAX (B) | 50V | 100V | 200V | 500V |
| E24 | 1 | 3 | 8.7 | 9.2 | 3.8 | 5.0 | 4.0 | 2.5 | 1.0 |
| E54 | 4 | | | | 14.8 | 20 | 16 | 10 | 4.0 |
| E26 | 1 | 5 | 13.6 | 14.9 | 3. | 16 | 12 | 7.5 | 3.3 |
| E56 | 4 | | | | 14.8 | 64 | 48 | 30 | 13 |
| E21 | 1 | 6 | 16.6 | 21.6 | 3.8 | 30 | 22 | 14 | 6.0 |
| E51 | 4 | | | | 14.8 | 120 | 88 | 56 | 24 |
| E28 | 1 | 14 | 38.2 | 12.0 | 3.8 | 35 | 25 | 16 | 7.0 |
| E58 | 4 | | | | 14.8 | 140 | 100 | 64 | 28 |
| E29 | 1 | 14 | 40.6 | 24.0 | 3.8 | 75 | 50 | 35 | 16 |
| E59 | 4 | | | | 14.8 | 300 | 200 | 140 | 64 |

Please refer to our website for complete offering including NP0 & BX capacitance ranges.



MINI-SWITCH-MODE® CAPACITORS

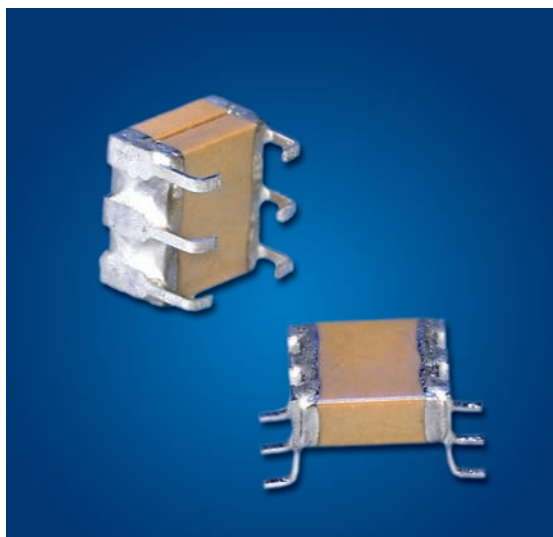

JDI's Mini Switch-Mode® ceramic capacitors combine the advantages of high capacitance found in tantalum capacitors with very low ESR performance of ceramic capacitors. The “J” and “L” lead configurations replace 1825 and 2225 SMT chips to provide stress relief and prevent cracking due to thermal cycling or mechanical board flexing. Another plus of the J-lead style is that this configuration allows use of the same solder lands as the SMT chips. See the Stacked Switch-Mode section for larger values. See also the Technical Notes on soldering and handling and suggested solder lands.

FEATURES

- High Capacitance, Small Size
- Low ESR/ESL
- Leadframe reduces thermal & mechanical stress due to board flexure and TCE mismatch

APPLICATIONS

- DC-DC Converters
- Power Supply Input & Output Filters

CAPACITANCE SELECTION

| SIZE CODE | EIA CHIP SIZE | NP0 Max Capacitance (uF) | | | | | X7R Max Capacitance (uF) | | | | |
|-----------|---------------|--------------------------|-------|-------|-------|-------|--------------------------|-----|------|------|------|
| | | 25V | 50V | 100V | 200V | 500V | 25V | 50V | 100V | 200V | 500V |
| P09 | 1825 | 0.056 | 0.047 | 0.039 | 0.027 | 0.018 | 1.5 | 1.2 | 0.75 | 0.56 | 0.27 |
| P29 | 1825 | 0.11 | 0.094 | 0.078 | 0.054 | 0.036 | 3.0 | 2.4 | 1.5 | 1.1 | 0.54 |
| P39 | 1825 | 0.16 | 0.14 | 0.11 | 0.081 | 0.054 | 4.5 | 3.6 | 2.2 | 1.6 | 0.81 |
| P49 | 1825 | 0.22 | 0.18 | 0.15 | 0.10 | 0.07 | 6.0 | 4.8 | 3.0 | 2.2 | 1.0 |
| P08 | 2225 | 0.068 | 0.056 | 0.047 | 0.033 | 0.027 | 2.7 | 2.2 | 1.5 | 1.2 | 0.39 |
| P28 | 2225 | 0.13 | 0.11 | 0.094 | 0.066 | 0.054 | 5.4 | 4.4 | 3.0 | 2.4 | 0.78 |
| P38 | 2225 | 0.20 | 0.16 | 0.14 | 0.10 | 0.081 | 8.1 | 6.6 | 4.5 | 3.6 | 1.1 |
| P48 | 2225 | 0.27 | 0.22 | 0.18 | 0.13 | 0.10 | 10 | 8.8 | 6.0 | 4.8 | 1.5 |

MINI-SWITCH-MODE® CAPACITORS

CASE SIZE

| DIMENSIONS APPLICABLE TO ALL SIZES: | | | | | | | | | | | | | | | | | | |
|--|------|------|-------|------|------|------|------|------|-------|------|-------|------|------|------|------|------|------|------|
| | IN. | MM | P08 | | P09 | | P28 | | P29 | | P38 | | P39 | | P48 | | P49 | |
| | IN. | MM | IN. | MM | IN. | MM | IN. | MM | IN. | MM | IN. | MM | IN. | MM | IN. | MM | IN. | MM |
| H ± .010 | .070 | 1.78 | | | | | | | | | | | | | | | | |
| C TYP. | .100 | 2.54 | | | | | | | | | | | | | | | | |
| P ± .015 | .065 | 1.65 | | | | | | | | | | | | | | | | |
| DIMENSIONS APPLICABLE TO SPECIFIC SIZES: | | | | | | | | | | | | | | | | | | |
| L MAX | .280 | 7.11 | 0.24 | 6.1 | 0.28 | 7.11 | 0.24 | 6.1 | 0.28 | 7.11 | 0.24 | 6.1 | 0.28 | 7.11 | 0.24 | 6.1 | 0.24 | 6.1 |
| W MAX | .270 | 6.86 | 0.27 | 6.86 | 0.27 | 6.86 | 0.27 | 6.86 | 0.27 | 6.86 | 0.27 | 6.86 | 0.27 | 6.86 | 0.27 | 6.86 | 0.27 | 6.86 |
| T MAX | .095 | 2.41 | 0.095 | 2.41 | 0.19 | 4.83 | 0.19 | 4.83 | 0.285 | 7.24 | 0.285 | 7.24 | 0.38 | 9.65 | 0.38 | 9.65 | 0.38 | 9.65 |

Note: J-Lead and L-Lead options are available on all sizes above

ELECTRICAL CHARACTERISTICS

| DIELECTRIC: | NP0 | X7R |
|---|---|------------------------------------|
| TEMPERATURE COEFFICIENT: | 0 ±30ppm/°C (-55 to +125°C) | ±15% (-55 to +125°C) |
| DISSIPATION FACTOR: | 0.1% max. | 2.5% max. |
| AGING: | None | -2.5% per decade hour |
| INSULATION RESISTANCE (MIN. @ 25°C, WVDC) | 1000 ΩF or 100 GΩ, whichever is less | 500 ΩF or 50 GΩ, whichever is less |
| DIELECTRIC STRENGTH: | For 500V Ratings: 750VDC, 25°C, 50mA max For 200V Ratings: 2xWVDC, 25°C, 50mA max For 25-100V Ratings: 2.5xWVDC, 25°C, 50mA max | |
| TEST CONDITIONS: | 1kHz ±50Hz; 1.0±0.2 VRMS | |
| OTHER: | See page 81 for additional dielectric specifications. | |

HOW TO ORDER - MINI SWITCHMODE®

Part number written: 500P28W395KJ4U

| 500 | P28 | W | 395 | K | J | 4 | U |
|---|-----------|--------------------|--|--|---|------------------------------|--|
| VOLTAGE | SIZE | DIELECTRIC | CAPACITANCE | TOLERANCE | TERMINATION | MARKING | PACKING |
| 250 = 25 V 500 = 50 V 101 = 100 V 201 = 200 V 501 = 500 V | See Chart | N = NP0 W = X7R | 1st two digits are significant; third digit denotes number of zeros. 103 = 0.01 μF 105 = 1.0 μF 106 = 10 μF | J = ±5% K = ±10% M = ±20% Z = +80% -20% | J = "J" Leads (formed in) L = "L" Leads (formed out) | 3 = Standard 4 = Unmarked | U = Tape and Reel 16mm, 13" Reel NONE = Bulk pack H = High Reliability testing per customer requirements S = Special Part |



BME MINI-SWITCH-MODE® CAPACITORS

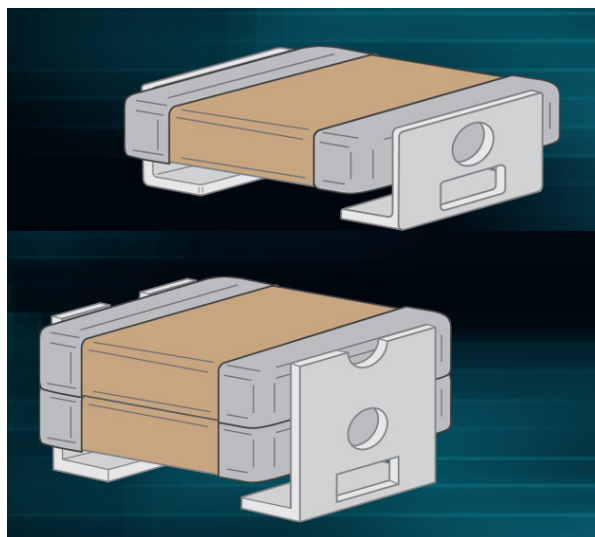

This new series of miniature switchmode power supply filter capacitors uses BME (Base Metal Electrode) construction to achieve 300-400% capacitance increases and component size reductions compared to their PME (Precious Metal Electrode) counterparts per the comparison examples below.

BME Size / Capacitance Comparison

| Technology | Chips | Volts | Max. Cap. |
|------------|----------------|-------------|-----------------------------|
| PME | 1x 1825 | 50V | 1.2 μ F |
| BME | 1x 1812 | 50V | 4.7μF |
| PME | 2x 2225 | 100V | 4.4 μ F |
| BME | 2x 2220 | 100V | 10μF |

FEATURES

- High Capacitance, Small Size
- Low ESR/ESL
- Leadframe reduces thermal & mechanical stress due to board flexure and TCE mismatch
- Green / ROHS Compliant

APPLICATIONS

- DC-DC Converters
- Power Supply Input & Output Filters
- High Capacitance Applications Where Increased Reliability is Required

CAPACITANCE / VOLTAGE

| CAPACITANCE RATING | DC VOLTAGE RATING | SIZE P0A 1812 SINGLE STACK | | SIZE P07 2220 SINGLE STACK | | SIZE P2A 1812 DOUBLE STACK | | SIZE P27 2220 DOUBLE STACK | |
|--------------------|-------------------|-------------------------------|----|-------------------------------|----|-------------------------------|----|-------------------------------|----|
| | | IN. | MM | IN. | MM | IN. | MM | IN. | MM |
| 2.2 μ F | 100V | 101P0AW225MJ4U+RC | | | | | | | |
| 4.7 μ F | 50V | 500P0AW475MJ4U+RC | | | | | | | |
| 4.7 μ F | 100V | | | 101P07W475MJ4U+RC | | 101P2AW475MJ4U+RC | | | |
| 10 μ F | 50V | | | 500P07W106MJ4U+RC | | 500P2AW106MJ4U+RC | | | |
| 10 μ F | 100V | | | | | | | 101P27W106MJ4U+RC | |
| 22 μ F | 50V | | | | | | | 500P27W226MJ4U+RC | |

CASE SIZE / PART NUMBER

| Mechanical Dimensions | IN. | | MM | | IN. | | MM | | IN. | | MM | |
|-----------------------|----------|-------|------|-------|-----|-------|------|-------|-----|-------|-----|--|
| | L MAX: | 0.217 | 5.5 | 0.256 | 6.5 | 0.217 | 5.5 | 0.256 | 6.5 | 0.256 | 6.5 | |
| | W MAX: | 0.157 | 4 | 0.217 | 5.5 | 0.157 | 4 | 0.217 | 5.5 | 0.217 | 5.5 | |
| | H MAX: | 0.102 | 2.6 | 0.118 | 3 | 0.205 | 5.2 | 0.236 | 6 | 0.236 | 6 | |
| | h1 TYP.: | 0.051 | 1.3 | 0.051 | 1.3 | 0.051 | 1.3 | 0.051 | 1.3 | 0.051 | 1.3 | |
| | p1 TYP.: | 0.121 | 3.08 | 0.177 | 4.5 | 0.121 | 3.08 | 0.177 | 4.5 | 0.177 | 4.5 | |
| | p2 TYP.: | 0.059 | 1.5 | 0.059 | 1.5 | 0.07 | 1.8 | 0.07 | 1.8 | 0.07 | 1.8 | |

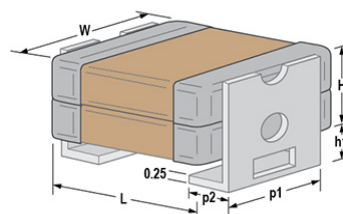
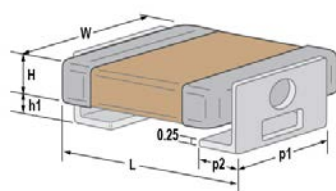

TYPICAL APPLICATION: DC-DC CONVERTER INPUT & OUTPUT FILTERING

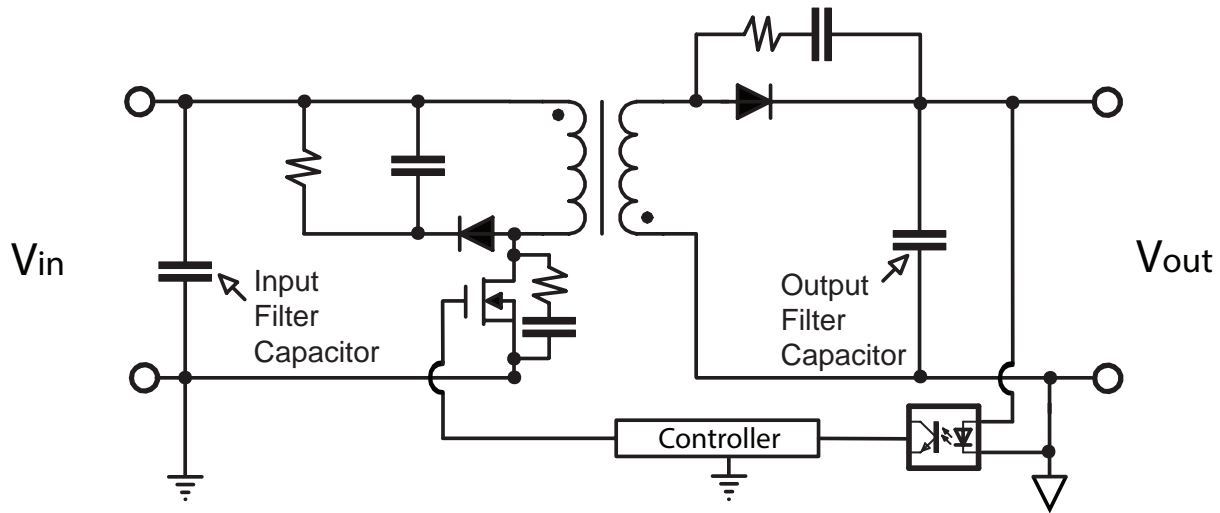

ELECTRICAL CHARACTERISTICS

| | |
|--------------------------|-------------------------------------|
| OPERATING RANGE: | -55 to +125°C |
| TEMPERATURE COEFFICIENT: | X7R, ±15% |
| DISSIPATION FACTOR: | 0.025 (2.5%) max. |
| AGING RATE: | <2.5% per decade |
| INSULATION RESISTANCE: | 10GΩ or 500 ΩF whichever is less |
| WITHSTANDING VOLTAGE: | 2 X WVDC |
| TEST CONDITIONS: | 1kHz ±50Hz; 1.0±0.2 VRMS, 25°C |

BME MINI SWITCHMODE TEMPERATURE COEFFICIENT

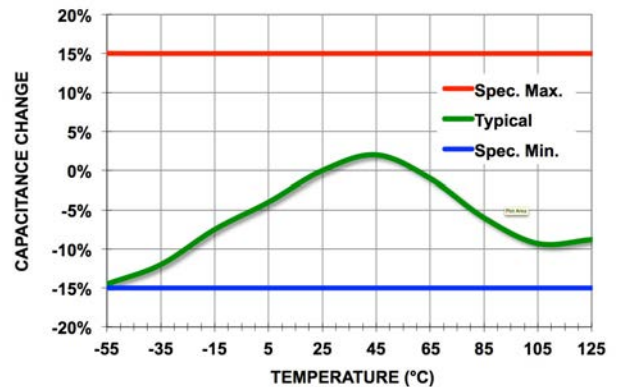

HOW TO ORDER - BME MINI SWITCH-MODE®

Part number written: 500P07W106MJ4U+RC

| 500 | P07 | W | 106 | M | J | 4 | U | +RC |
|---------------------------|-----------|------------|---|-----------|---------------------------|--------------|--|----------------------|
| VOLTAGE | SIZE | DIELECTRIC | CAPACITANCE | TOLERANCE | TERMINATION | MARKING | PACKING | ROHS CODE |
| 500 = 50 V 101 = 100 V | See Chart | W = X7R | 1st two digits are significant; third digit denotes number of zeros. 225 = 2.2 μF 106 = 10 μF | M = ±20% | J = "J" Leads (formed in) | 4 = Unmarked | U = Embossed Tape 13" Reel per EIA RS481 | +RC = RoHS Compliant |



SWITCH-MODE RADIAL LEADED CAPACITORS

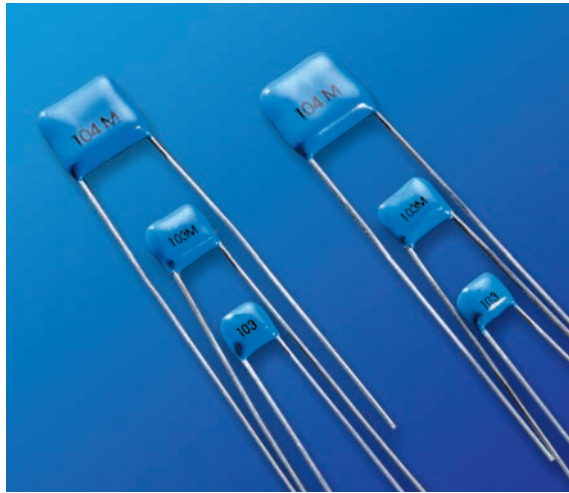





KEY FEATURES

- Rated Working Voltages from 25 to 500 VDC
- Rugged Epoxy Coating Offers Increased Protection
- Hi-Rel Screened Versions Available
- Custom Sizes, Voltages, and Values Available

ADVANTAGES





- Power Supplies
- Voltage Multipliers
- Data Isolation
- Surge Protection
- Industrial Control Circuits
- Custom Applications

CASE SIZE

| | | IN. | (MM) | RATED VOLTAGE | NP0 CAPACITANCE (MAX.) | | X7R CAPACITANCE (MAX.) | |
|---|----|-----------|-------------|---------------|------------------------|--------------|------------------------|--------------|
| | | | | | VALUE | CODE | VALUE | CODE |
|  H03 | W | .300 max. | (7.62 max.) | 25 VDC | .070 μ F | 703 | 2.00 μ F | 205 |
| | H | .300 max. | (7.62 max.) | 50 VDC | .060 μ F | 603 | 1.60 μ F | 165 |
| | T | .200 max. | (5.08 max.) | 100 VDC | .050 μ F | 503 | 1.10 μ F | 115 |
| | S | .200 nom. | (5.08 nom.) | 200 VDC | .040 μ F | 403 | .730 μ F | 734 |
| | LD | .020 nom. | (.510 nom.) | 500 VDC | .020 μ F | 203 | .250 μ F | 254 |
| | | | | | 25 VDC | .120 μ F | 124 | 5.10 μ F |
|  H04 | W | .400 max. | (10.2 max.) | 50 VDC | .100 μ F | 104 | 4.10 μ F | 415 |
| | H | .400 max. | (10.2 max.) | 100 VDC | .082 μ F | 823 | 2.70 μ F | 275 |
| | T | .200 max. | (5.08 max.) | 200 VDC | .050 μ F | 503 | 1.80 μ F | 185 |
| | S | .200 nom. | (5.08 nom.) | 500 VDC | .030 μ F | 303 | .670 μ F | 674 |
| | LD | .020 nom. | (.510 nom.) | 25 VDC | .240 μ F | 244 | 8.70 μ F | 875 |
| | | | | | 50 VDC | .200 μ F | 204 | 7.20 μ F |
|  H05 | W | .500 max. | (12.7 max.) | 100 VDC | .180 μ F | 184 | 4.80 μ F | 485 |
| | H | .500 max. | (12.7 max.) | 200 VDC | .110 μ F | 114 | 3.30 μ F | 335 |
| | T | .200 max. | (5.08 max.) | 500 VDC | .070 μ F | 703 | 1.10 μ F | 115 |
| | S | .400 nom. | (10.2 nom.) | 25 VDC | .750 μ F | 754 | 22.0 μ F | 226 |
| | LD | .025 nom. | (.635 nom.) | 50 VDC | .620 μ F | 624 | 17.0 μ F | 176 |
| | | | | | 100 VDC | .560 μ F | 564 | 13.0 μ F |
|  H06 | W | .870 max. | (22.1 max.) | 200 VDC | .360 μ F | 364 | 8.00 μ F | 805 |
| | H | .600 max. | (15.2 max.) | 500 VDC | .240 μ F | 244 | 2.90 μ F | 295 |
| | T | .200 max. | (5.08 max.) | 25 VDC | .750 μ F | 754 | 22.0 μ F | 226 |
| | S | .790 nom. | (20.1 nom.) | 50 VDC | .620 μ F | 624 | 17.0 μ F | 176 |
| | LD | .032 nom. | (.813 nom.) | 100 VDC | .560 μ F | 564 | 13.0 μ F | 136 |
| | | | | | 200 VDC | .360 μ F | 364 | 8.00 μ F |

See page 81 for additional dielectric specifications.

SWITCH-MODE RADIAL LEADED CAPACITORS

| CASE SIZE | | IN. | (MM) | RATED VOLTAGE | NP0 CAPACITANCE (MAX.) | | X7R CAPACITANCE (MAX.) | |
|---|----|-----------|-------------|---------------|------------------------|---------|------------------------|---------|
| | | | | | VALUE | CODE | VALUE | CODE |
|  H07 | W | 1.10 max. | (27.9 max.) | 25 VDC | .680 µF | 684 | 35.0 µF | 356 |
| | H | .600 max. | (15.2 max.) | 50 VDC | .560 µF | 564 | 28.0 µF | 286 |
| | T | .200 max. | (5.08 max.) | 100 VDC | .470 µF | 474 | 19.0 µF | 196 |
| | S | .980 nom. | (24.9 nom.) | 200 VDC | .330 µF | 334 | 13.0 µF | 136 |
| | LD | .032 nom. | (.813 nom.) | 500 VDC | .200 µF | 204 | 4.60 µF | 465 |
| | | | | | 25 VDC | 1.20 µF | 125 | 70.0 µF |
|  H08 | W | 1.10 max. | (27.9 max.) | 50 VDC | 1.10 µF | 115 | 56.0 µF | 566 |
| | H | .600 max. | (15.2 max.) | 100 VDC | .820 µF | 824 | 37.0 µF | 376 |
| | T | .350 max. | (8.89 max.) | 200 VDC | .470 µF | 474 | 26.0 µF | 266 |
| | S | .980 nom. | (24.9 nom.) | 500 VDC | .300 µF | 304 | 8.70 µF | 875 |
| | LD | .032 nom. | (.813 nom.) | | | | | |
| | | | | | 25 VDC | .450 µF | 454 | 13.0 µF |
|  H09 | W | .670 max. | (17 max.) | 50 VDC | .360 µF | 364 | 10.0 µF | 106 |
| | H | .540 max. | (13.7 max.) | 100 VDC | .330 µF | 334 | 7.20 µF | 725 |
| | T | .200 max. | (5.08 max.) | 200 VDC | .240 µF | 244 | 5.00 µF | 505 |
| | S | .575 nom. | (14.6 nom.) | 500 VDC | .180 µF | 184 | 1.70 µF | 175 |
| | LD | .025 nom. | (.635 nom.) | | | | | |
| | | | | | 25 VDC | 1.00 µF | 105 | 38.0 µF |
|  H10 | W | .930 max. | (23.6 max.) | 50 VDC | .900 µF | 904 | 30.0 µF | 306 |
| | H | .720 max. | (18.3 max.) | 100 VDC | .750 µF | 754 | 20.0 µF | 206 |
| | T | .250 max. | (6.35 max.) | 200 VDC | .470 µF | 474 | 14.0 µF | 146 |
| | S | .800 nom. | (20.3 nom.) | 500 VDC | .300 µF | 304 | 5.80 µF | 585 |
| | LD | .032 nom. | (.813 nom.) | | | | | |
| | | | | | | | | |

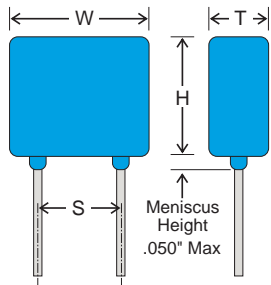

NOTE: Lead lengths are typically 1.25" for orders in bulk packaging. Leads are typically 1.00" for tape and reel packaging. Tape and reel packaging comes in 1000 piece reels.

HOW TO ORDER SWITCH-MODE RADIALS

Part number written: 201H07W105KQ4

| 201 | H07 | W | 105 | K | Q | 4 | T |
|---|-------------|--------------------|---|---|---------------------------|-------------------------------|---|
| VOLTAGE | SIZE | DIELECTRIC | CAPACITANCE | TOLERANCE | TERMINATION | MARKING | PACKING |
| 250 = 25 V 500 = 50 V 101 = 100 V 201 = 200 V 501 = 500 V | See Chart | N = NP0 W = X7R | 1st two digits are significant; third digit denotes number of zeros. 101 = 100 pF 102 = 1000 pF 103 = 0.01 µF 105 = 1.00 µF | J = ± 5% K = ± 10% M = ± 20% Z = +80% -20% | Q = Leaded & Encapsulated | 4 = Standard 3 = Specified | T = Tape and Reel H = High Rel Testing per customer requirements S = Special Part |



HIGH VOLTAGE RADIAL LEADED CAPACITORS

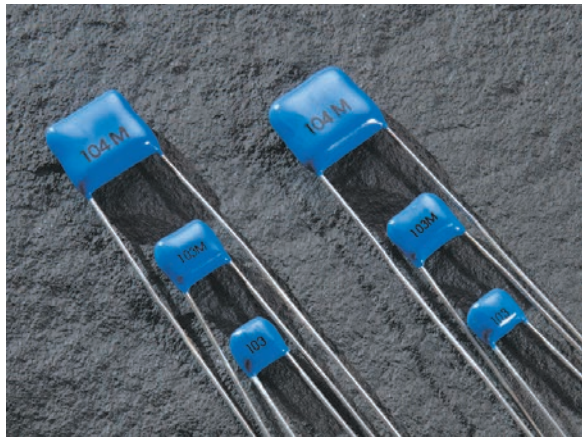





KEY FEATURES

- Rated Working Voltages from 500 to 5000 VDC
- Rugged Epoxy Coating Offers Increased Protection
- Compact MLC Designs Smaller Than Film or Disc
- NEW 200°C Versions Available for Oil & Geophysical Tool, Aircraft Engine Control Applications
- DSCC Drawing & Other Screened Versions Available

ADVANTAGES



- Power Supplies
- Voltage Multipliers
- Data Isolation
- Surge Protection
- Industrial Control Circuits
- Custom Applications

CASE SIZE

| | | IN. | (MM) | RATED VOLTAGE | NP0 CAPACITANCE (MAX.) | | X7R CAPACITANCE (MAX.) | |
|--|----|-------------|--------------|---------------|------------------------|---------|------------------------|---------|
| | | | | | VALUE | CODE | VALUE | CODE |
|  H42 | W | 0.250 Max | (6.35 Max) | 500 VDC | 4700 pF | 472 | .150 µF | 154 |
| | H | 0.220 Max | (5.59 Max) | 1000 VDC | 1500 pF | 152 | .055 µF | 553 |
| | T | 0.270 Max | (6.86 Max) | 2000 VDC | 680 pF | 681 | 9000 pF | 902 |
| | S | 0.170 ±0.03 | (4.32 ±0.76) | 3000 VDC | 330 pF | 331 | 2800 pF | 282 |
| | LD | 0.025 ±.002 | (0.64 ±0.05) | 4000 VDC | 150 pF | 151 | 630 pF | 631 |
| | | | | | 5000 VDC | 100 pF | 101 | 550 pF |
|  H47 | W | 0.370 Max | (9.40 Max) | 500 VDC | .022 µF | 223 | .480 µF | 484 |
| | H | 0.300 Max | (7.62 Max) | 1000 VDC | 3300 pF | 332 | .170 µF | 174 |
| | T | 0.270 Max | (6.86 Max) | 2000 VDC | 1500 pF | 152 | .025 µF | 253 |
| | S | 0.275 ±0.03 | (6.99 ±0.76) | 3000 VDC | 680 pF | 681 | .011 µF | 113 |
| | LD | 0.025 ±.002 | (0.64 ±0.05) | 4000 VDC | 330 pF | 331 | 1800 pF | 182 |
| | | | | | 5000 VDC | 220 pF | 221 | 940 pF |
|  H51 | W | 0.470 Max | (12.0 Max) | 500 VDC | .056 µF | 563 | 1.20 µF | 125 |
| | H | 0.400 Max | (10.2 Max) | 1000 VDC | 4700 pF | 472 | .450 µF | 454 |
| | T | 0.320 Max | (8.13 Max) | 2000 VDC | 3300 pF | 332 | .094 µF | 943 |
| | S | 0.375 ±0.03 | (9.53 ±0.76) | 3000 VDC | 1500 pF | 152 | .043 µF | 433 |
| | LD | 0.025 ±.002 | (0.64 ±0.05) | 4000 VDC | 1000 pF | 102 | .010 µF | 103 |
| | | | | | 5000 VDC | 470 pF | 471 | 4900 pF |
|  H62 | W | 0.570 Max | (14.5 Max) | 500 VDC | .100 µF | 104 | 2.20 µF | 225 |
| | H | 0.500 Max | (12.7 Max) | 1000 VDC | .010 µF | 103 | .804 µF | 804 |
| | T | 0.320 Max | (8.13 Max) | 2000 VDC | 6800 pF | 682 | .240 µF | 244 |
| | S | 0.475 ±0.03 | (12.1 ±0.76) | 3000 VDC | 3300 pF | 332 | .073 µF | 733 |
| | LD | 0.025 ±.002 | (0.64 ±0.05) | 4000 VDC | 2200 pF | 222 | .028 µF | 283 |
| | | | | | 5000 VDC | 1000 pF | 102 | .013 µF |
|  H66 | W | 0.670 Max | (17.0 Max) | 500 VDC | .150 µF | 154 | 3.30 µF | 335 |
| | H | 0.600 Max | (15.2 Max) | 1000 VDC | .015 µF | 153 | 1.20 µF | 125 |
| | T | 0.320 Max | (8.13 Max) | 2000 VDC | .010 µF | 103 | .440 µF | 444 |
| | S | 0.575 ±0.03 | (14.6 ±0.76) | 3000 VDC | 4700 pF | 472 | 0.130 µF | 134 |
| | LD | 0.025 ±.002 | (0.64 ±0.05) | 4000 VDC | 3300 pF | 332 | .041 µF | 413 |
| | | | | | 5000 VDC | 2200 pF | 222 | .020 µF |

See page 79 for additional dielectric specifications.

HIGH VOLTAGE RADIAL LEADED CAPACITORS

| CASE SIZE | | | RATED VOLTAGE | NP0 CAPACITANCE (MAX.) | | X7R CAPACITANCE (MAX.) | |
|--|---|----------|---------------|------------------------|------|------------------------|------|
| | | | | VALUE | CODE | VALUE | CODE |
|  H70 | W 0.770 Max (19.6 Max) H 0.720 Max (18.3 Max) T 0.320 Max (8.13 Max) S 0.675 ±0.03 (17.1 ±0.76) LD 0.025 ±.002 (0.64 ±0.05) | IN. (MM) | 500 VDC | .220 µF | 224 | 5.70 µF | 575 |
| | | | 1000 VDC | .022 µF | 223 | 2.10 µF | 215 |
| | | | 2000 VDC | .015 µF | 153 | .620 µF | 624 |
| | | | 3000 VDC | 6800 pF | 682 | .190 µF | 194 |
| | | | 4000 VDC | 4700 pF | 472 | .054 µF | 543 |
| | | | 5000 VDC | 3300 pF | 332 | .026 µF | 263 |
|  H72 | W 0.870 Max (22.1 Max) H 0.750 Max (19.1 Max) T 0.320 Max (8.13 Max) S 0.675 ±0.03 (19.7 ±0.76) LD 0.025 ±.002 (0.64 ±0.05) | IN. (MM) | 500 VDC | .330 µF | 334 | 7.30 µF | 735 |
| | | | 1000 VDC | .100 µF | 104 | 2.80 µF | 285 |
| | | | 2000 VDC | .056 µF | 563 | .800 µF | 804 |
| | | | 3000 VDC | .033 µF | 333 | .250 µF | 254 |
| | | | 4000 VDC | .010 µF | 103 | .080 µF | 803 |
| | | | 5000 VDC | 6800 pF | 682 | .041 µF | 413 |
|  H80 | W 1.450 Max (36.8 Max) H 0.720 Max (18.3 Max) T 0.320 Max (8.13 Max) S 1.375 ±0.03 (34.9 ±0.76) LD 0.025 ±.002 (.064 ±0.05) | IN. (MM) | 500 VDC | .470 µF | 474 | 12.0 µF | 126 |
| | | | 1000 VDC | .150 µF | 154 | 4.60 µF | 465 |
| | | | 2000 VDC | .082 µF | 823 | 1.20 µF | 125 |
| | | | 3000 VDC | .047 µF | 473 | .390 µF | 394 |
| | | | 4000 VDC | .015 µF | 153 | .130 µF | 134 |
| | | | 5000 VDC | .010 µF | 103 | .068 µF | 683 |

T-SERIES 200°C

Johanson also offers two different series of high temperature radial leaded capacitors for 200°C. These components feature rugged premolded cases with Hi-Temp epoxy fill. The 200°C line is offered in voltage ratings of 25V to 4KV and maximum capacitance loss of -0.5% in NP0 and -45% in X7R. The line is offered in voltage ratings of 50V & 100V with maximum capacitance loss of -1.5% in NP0 and -55% in X7R. Please visit our website for complete component selection & specifications

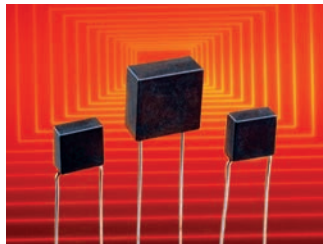

APPLICATIONS

- Oil Well Logging (Downhole)
- Geophysical Probes
- Jet Engine Controls

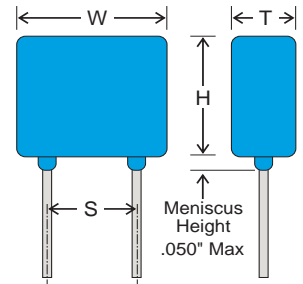

NOTE: Lead lengths are typically 1.25" for orders in bulk packaging. Leads are typically 1.00" for tape and reel packaging. Tape and reel packaging comes in 1000 piece reels.

HOW TO ORDER HIGH VOLTAGE RADIALS

Part number written: 102H42W101KQ4

| 102 | H42 | W | 101 | K | Q | 4 | T |
|---|-----------|--------------------|---|---|---------------------------|-------------------------------|---|
| VOLTAGE | SIZE | DIELECTRIC | CAPACITANCE | TOLERANCE | TERMINATION | MARKING | PACKING |
| 501 = 500 V 102 = 1000 V 202 = 2000 V 302 = 3000 V 402 = 4000 V 502 = 5000 V | See Chart | N = NP0 W = X7R | 1st two digits are significant; third digit denotes number of zeros. 102 = 1000 pF 103 = 0.01 µF 105 = 1.00 µF | J = ± 5% K = ± 10% M = ± 20% Z = +80% -20% | Q = Leaded & Encapsulated | 4 = Standard 3 = Specified | T = Tape and Reel H = High Rel Testing per customer requirements S = Special Part |



PLANAR CAPACITOR ARRAYS FOR EMI FILTERING

Johanson Dielectrics is the premier supplier of Planar Capacitor EMI Filter Arrays to the Filtered Connector Industry. Johanson filters exhibit excellent RF performance, as well as high SRF's (Series Resonant Frequency). Planar Capacitors are the fundamental building block for filtered connectors in Aerospace, Biomedical, Military, Satellite, Industrial and Communication electronics.

Johanson offers NP0, X7R and MOV (Metal Oxide Varistor) Planar Arrays in standard and custom solutions to fit your needs (1 to 150 pins).

MOV planar arrays can be used singularly to form low pass C filters with the additional benefit of transient voltage protection. When combined together with planar array capacitors, they can form balanced and unbalanced Pi filters with transient voltage protection. The MOV technology enables smaller connectors to be built when compared to other discrete voltage protection component solutions, such as diodes.

We are eager to quote your custom requirements and unique products, in addition to your commercial or Mil-Standard needs.

Each Johanson part is customized to meet specific customer needs.

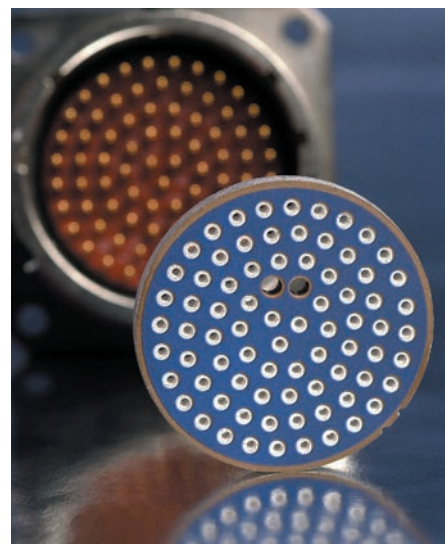

CIRCULAR ARRAYS

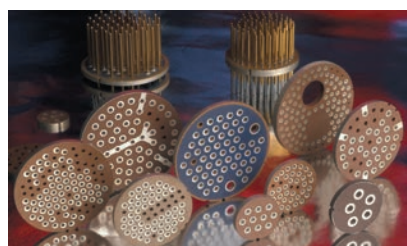

| EXAMPLE PHYSICAL LAYOUT | DIELECTRIC MATERIAL | AVAILABLE CAPACITANCE | WORKING VOLTAGE | DWV VOLTAGE |
|--|-------------------------------|------------------------|-----------------------|------------------------|
| MIL-1560 MIL-1554 MIL-1669 MIL-1651 MIL-1698 MIL-33702 MIL-AUDIO | X7R, NP0 & Selected MOV | 47 pF to 1000 nF | Up to 2,000 VDC | Up to 2,500V VDC |

RECTANGULAR ARRAYS (ARINC 404/600)

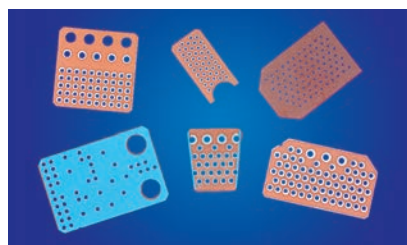

| EXAMPLE PHYSICAL LAYOUT | DIELECTRIC MATERIAL | AVAILABLE CAPACITANCE | WORKING VOLTAGE | DWV VOLTAGE |
|-----------------------------|-------------------------------|------------------------|-----------------------|------------------------|
| AR-010 Through AR-150 | X7R, NP0 & Selected MOV | 47 pF to 1000 nF | Up to 2,000 VDC | Up to 2,500V VDC |

D-SUBMINATURE RECTANGULAR ARRAYS

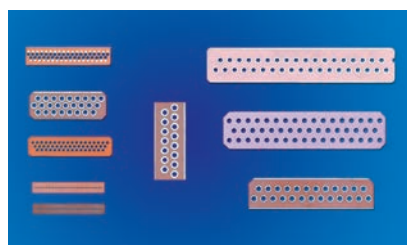

| EXAMPLE PHYSICAL LAYOUT | DIELECTRIC MATERIAL | AVAILABLE CAPACITANCE | WORKING VOLTAGE | DWV VOLTAGE |
|-------------------------|-------------------------------|-----------------------|-----------------|-------------|
| Full Size | X7R, NP0 & Selected MOV | 47pF - 210nF | ≤ 2,400 | ≤ 3,600 |
| Mini-D | | 47pF - 100nF | ≤ 1,000 | ≤ 1,500 |
| Micro-D | | 47pF - 22.5nF | ≤ 680 | ≤ 1,020 |
| Nano-D | | 47pF - 3.0nF | ≤ 200 | ≤ 500 |
| Combo-D | | 47pF - 6.0nF | ≤ 800 | ≤ 1,200 |
| Power-D | | 47pF - 120nF | ≤ 680 | ≤ 1,020 |
| Special | | 47pF - 50nF | ≤ 300 | ≤ 750 |



PLANAR CAPACITOR ARRAYS FOR EMI FILTERING

CUSTOM ARRAYS

Johanson Dielectrics's design expertise and CNC manufacturing process enable broad custom array capability. Many shapes, configurations and geometries are possible. Share your requirements and we will create a solution!

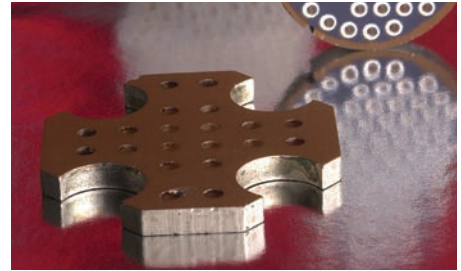

DISCOIDAL CAPACITORS

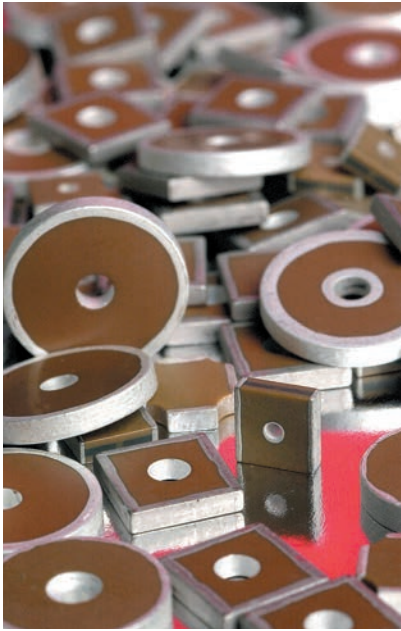

Johanson Discoidal Feed-through Capacitors are the functional element in widely used EMI feed-through filters. This capacitor configuration offers very low impedance and inductance. Discoidal capacitors are ideal for by-pass, filtering, coupling, single line EMI/RFI suppression, and high frequency applications.

- Capacitance values from 10 pF to 11.2 μ F
- Test standards and procedures per MIL-STD-202 and MIL-C-123
- Voltage ratings from 50 to 3000 VDC and 50 to 240 VAC
- Low ESR and ESL, non-polar designs

Call us to discuss your special requirements!

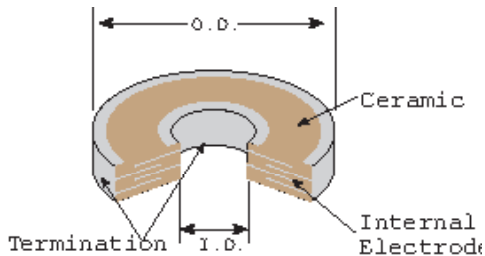

| EXAMPLE NOMINAL O.D. (IN.) | DIELECTRIC MATERIAL | AVAILABLE CAPACITANCE | INSIDE DIAMETER (IN.) | THICKNESS (IN.) | RATED VOLTAGE |
|----------------------------|-------------------------------|-----------------------|-----------------------|-----------------|----------------|
| 0.100 ±.005 | X7R, NPO & Selected MOV | 10 pF – 66 nF | 0.025 ±0.048 | 0.025 ±0.070 | Up to 200 VDC |
| 0.150 ±.005 | | 10 pF – 200 nF | 0.037 ±0.058 | 0.025 ±0.070 | Up to 200 VDC |
| 0.335 ±.005 | | 10 pF – 2.8 μ F | 0.034 ±0.088 | 0.040 ±0.110 | Up to 500 VDC |
| 0.345 ±.005 | | 10 pF – 6.0 μ F | 0.040 ±0.085 | 0.055 ±0.110 | Up to 750 VDC |
| 0.376 ±.005 | | 10 pF – 8.0 μ F | 0.050 ±0.075 | 0.065 ±0.125 | Up to 750 VDC |
| 0.643 ±.005 | | 10 pF – 15 μ F | 0.063 ±0.080 | 0.055 ±0.150 | Up to 750 VDC |
| 0.840 ±.005 | | 10 pF – 20 μ F | 0.050 ±0.075 | 0.080 ±0.130 | Up to 1000 VDC |

CAPSTRATE® CAPACITOR SUBSTRATES

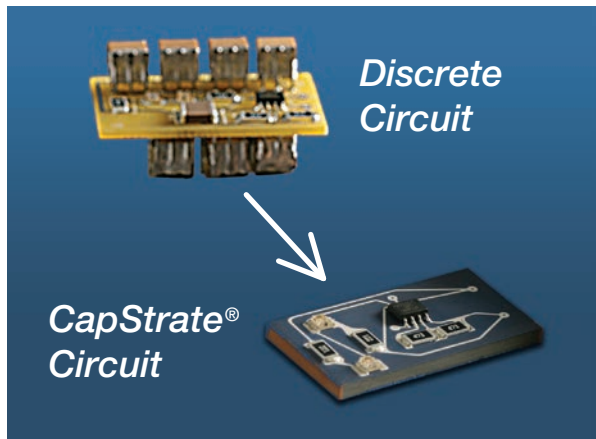

Johanson CapStrate® products integrate bulk capacitance into a ceramic substrate eliminating large discrete capacitive components which saves critical space and simplifies the assembly process. Our design and manufacturing expertise in large format, custom geometries provides innovative solutions that economically solve a wide variety of your design challenges.

ADVANTAGES

- Major Size & Weight Reduction
- Fewer Solder Joints
- Lower Assembly Cost
- Circuit Assembly Available

KEY FEATURES

- Integrated Capacitance in The Substrate
- Rated Working Voltages from 50V to 5,000V
- Temperature ranges: -55°C to 125°C (specials to 200°C and 250°C)
- Compact Designs Utilizing Military Grade Ceramics
- Custom Sizes, Values, and Voltages Available

SIZE / CAPACITANCE CAPABILITY EXAMPLES

| SUBSTRATE SIZE | | LENGTH | WIDTH | THICK | NP0 50V | NP0 100V | NP0 200V | NP0 500V | X7R 50V | X7R 100V | X7R 200V | X7R 500V |
|---|----|--------|-------|-------|----------------------------------|----------------------------------|----------------------------------|---------------------------------|---------------------------------|---------------------------------|----------------------------------|-------------------------------|
| CapStrate 4 | In | 0.400 | 0.400 | 0.120 | 0.22µF | 0.15µF | 0.12µF | 0.07µF | 9.0µF | 6.0µF | 3.0µF | 1.5µF |
| | mm | 10.2 | 10.2 | 3.1 | | | | | | | | |
| CapStrate 3 | In | 0.450 | 1.00 | 0.120 | 0.70µF | 0.50µF | 0.39µF | 0.22µF | 28.0µF | 20.0µF | 9.0µF | 4.7µF |
| | mm | 11.43 | 25.4 | 3.1 | | | | | | | | |
| CapStrate 1 | In | 0.450 | 2.00 | 0.120 | 1.40µF | 1.00µF | 0.75µF | 0.44µF | 50.0µF | 40.0µF | 18.0µF | 9.4µF |
| | mm | 11.4 | 50.8 | 3.1 | | | | | | | | |
| CapStrate 2 | In | 0.800 | 1.50 | 0.120 | 2.00µF | 1.40µF | 1.00µF | 0.60µF | 75.0µF | 55.0µF | 25.0µF | 14.0µF |
| | mm | 20.3 | 38.1 | 3.1 | | | | | | | | |
| CapStrate 6 | In | 1.250 | 2.00 | 0.120 | 4.00µF | 2.80µF | 2.00µF | 1.20µF | 150.0µF | 110.0µF | 50.0µF | 28.0µF |
| | mm | 31.8 | 50.8 | 3.1 | | | | | | | | |
| Circular CapStrate® Capacitance Formula | | | | | 1.3 -1.6 µF / In ² | 0.9 -1.1 µF / In ² | 0.7 -0.8 µF / In ² | 50 - 62 µF / In ² | 35 - 45 µF / In ² | 18 - 20 µF / In ² | 1.3 -1.6 µF / In ² | 9 -10 µF / In ² |

This chart is intended to provide capability examples. Not all possibilities are shown and we invite application specific inquiries. Circular CapStrate® example lists available capacitance per area.



CUSTOM CAPACITOR SOLUTIONS

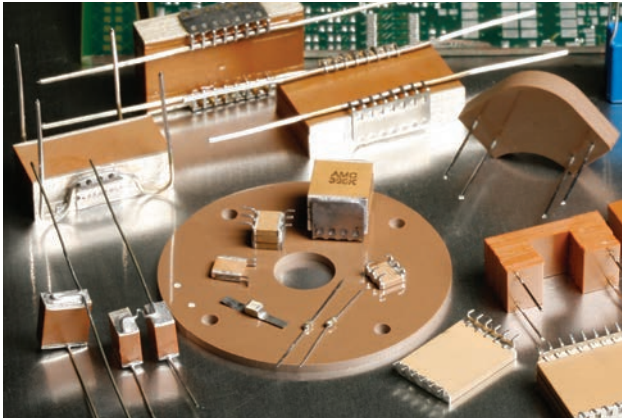

Johanson's extensive experience in design and manufacture of large format, custom geometries allows us to develop unique and innovative solutions which successfully solve a wide variety of our customer's design challenges. We'll work pro actively with you to fully understand your requirements and recommend the best solution possible.

KEY FEATURES

- Custom shapes to fit specific requirements
- Multiple capacitors in a single assembly
- NP0/COG and X7R solutions from -55°C to +125°C
- Multiple pin, lead-frame, and flying wire options
- Bare ceramic, epoxy coated, potted solutions

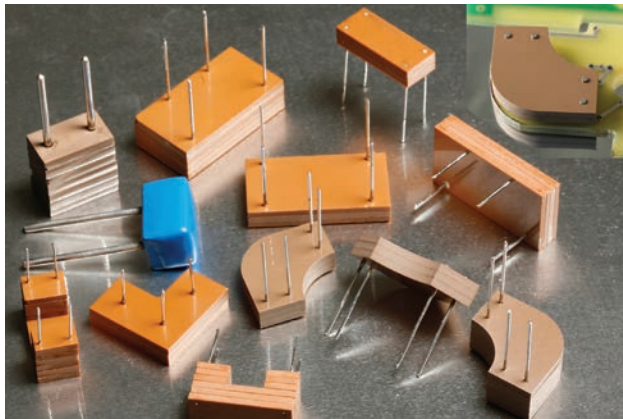

VARIABLE PITCH ASSEMBLIES

Another custom approach is our variable pitch design. No longer are you limited to a vendor's standard catalogue offering or only square or rectangular custom designs. We let you become your own capacitor designer by not only telling us the desired capacitance and voltage, but also the size, shape, and location of leads! This process helps insure that the resulting capacitor satisfies every aspect of your design requirements.

ON-LINE PRODUCTS

200°C Radial Leaded Capacitors
Large Size MLC Capacitors
High Power AC Capacitors

CAPACITOR GENERAL ELECTRICAL CHARACTERISTICS & PN BREAKDOWN

ELECTRICAL CHARACTERISTICS

| PARAMETER | NP0 | | X7R | | X5R | |
|--------------------------|--|---------------|--|---------------|--|--------------|
| TEMPERATURE COEFFICIENT: | 0 ± 30 ppm/°C | -55 to +125°C | ± 15% | -55 to +125°C | ± 15% | -55 to +85°C |
| | | | | | | |
| DISSIPATION FACTOR: | .001 (0.1%) max | | WVDC ≥ 50 VDC, DF = 2.5% max WVDC = 25 VDC, DF = 3.0% max WVDC = 16 VDC, DF = 3.5% max | | For Vrated ≥ 50 VDC, DF = 5% max For Vrated ≤ 25 VDC: DF = 10% max | |
| AGING: | None | | 2.5% / decade hour | | 2.5% / decade hour | |
| INSULATION RESISTANCE: | 1000ΩF or 100GΩ whichever is less @ 25°C, WVDC | | 500ΩF or 50GΩ whichever is less @ 25°C, WVDC | | 100ΩF or 10GΩ whichever is less @ 25°C, WVDC | |
| DIELECTRIC STRENGTH: | For Vrated = 6 - 200 VDC, DWV = 2.5 X WVDC, 25°C, 50mA max. For Vrated = 201 - 499 VDC, DWV = 2.0 X WVDC, 25°C, 50mA max. For Vrated = 500 - 999 VDC, DWV = 1.5 X WVDC, 25°C, 50mA max. For Vrated = 1000+ VDC, DWV = 1.2 X WVDC, 25°C, 50mA max. | | | | DWV = 2.5 X WVDC, 25°C, 50mA max. | |
| TEST PARAMETERS: | C > 100 pF; 1kHz ±50Hz; 1.0±0.2 VRMS C ≤ 100 pF 1Mhz ±50kHz; 1.0±0.2 VRMS | | Capacitance values ≤ 10 μF: 1.0kHz±50Hz @ 1.0±0.2 Vrms Capacitance values > 10 μF: 120Hz±10Hz @ 0.5V±0.1 Vrms | | Capacitance values ≤ 10 μF: 1.0kHz±50Hz @ 1.0±0.2 Vrms Capacitance values > 10 μF: 120Hz±10Hz @ 0.5V±0.1 Vrms | |
| NOTES: | Tanceram IR = 100 ΩF or 10 GΩ Tanceram DF for Vrated ≥ 50 VDC = 5% max. Tanceram DF for Vrated ≤ 25 VDC, DF = 10% max | | | | | |

PART NUMBER BREAKDOWN - SURFACE MOUNT

Part number written: 502R29W102KV3E-****-SC

| 502 | R 29 | W | 102 | K | V | 3 | E |
|--|---|-------------------------------|--|---|---|--|--|
| VOLTAGE | SERIES/SIZE | DIELECTRIC | CAPACITANCE | TOLERANCE | TERMINATION | MARKING | PACKING |
| 6R3 = 6.3 V DC 10 = 10 V DC 16 = 16 V DC 25 = 25 V DC 50 = 50 V DC 101 = 100 V DC 201 = 200 V DC 251 = 250 V DC 301 = 300 V DC 501 = 500 V DC 631 = 630 V DC 102 = 1000 V DC 202 = 2000 V DC 302 = 3000 V DC* 402 = 4000 V DC 502 = 5000 V DC* ACJ = 250 VAC * For Safety Caps with -****-SC P/N suffix only: 302 = 250VAC [2500V Impulse] 502 = 250VAC [5000V Impulse] | A__ = ARRAY B__ = LICC F__ = F-T FILTER R__ = MLCC S__ = MLCC T__ = HI TEMP MLCC X__ = X2Y __05=0201 __07=0402 __14=0603 __15=0805 __18=1206 __41=1210 __29=1808 __30=2211 __43=1812 __44=1410 __47=2220 __49=1825 __48=2225 | N = NP0 W = X7R X = X5R | 1st two digits are significant; third digit denotes number of zeros, R = decimal. 5R6 = 5.6 pF 100 = 10 pF 102 = 1,000 pF 474 = 0.47 μF 475 = 4.7 μF 106 = 10 μF | * B = ± 0.10 pF * C = ± 0.25 pF * D = ± 0.50 pF F = ± 1% G = ± 2% J = ± 5% K = ± 10% M = ± 20% Y = +50 -20% Z = +80 -20% *Values < 10 pF only | V = Nickel Barrier with 100% Tin Plating (Matte) F = Polyterm flexible termination G = Gold T = SnPb P = PdAg | 3 = Special 4 = Unmarked 6 = EIA Code* *Not available on sizes ≤ 0402 | E = Embossed 7" T = Punched 7" U = Embossed 13" R = Punched 13" No code = bulk pack Tape specifications conform to EIA RS481 Not all tape styles are available on all parts. |
| ****-SC | | | | | | | SC |
| PART NUMBER MODIFIER | | | | | | | |
| Used on select parts such as Safety Certified or for customer specific requirements. | | | | | | | |

PLEASE NOTE: Not all combinations of JDI P/Ns are valid. Please refer to the "How to Order" detail section of the specific product or contact your Sales Representative if you need assistance.



CAPACITOR PACKAGING

Johanson capacitors are available taped per EIA standard 481. Tape options include 7" and 13" diameter reels. Johanson uses high quality, dust free, punched 8mm paper tape and plastic embossed 8mm tape for thicker MLCCs. Quantity per reel ranges are listed in the tables below and are dependent on chip thickness.

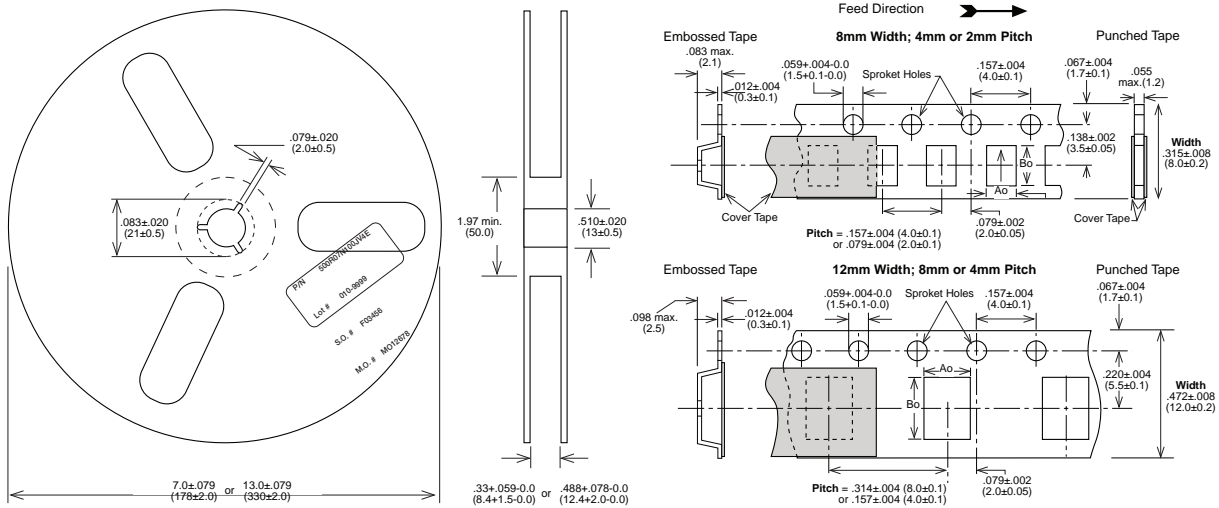
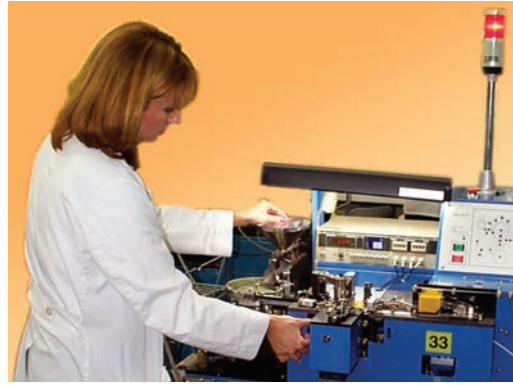

| COMPONENT | 7" DIAMETER REEL | | | | 13" DIAMETER REEL | | | |
|-----------------|------------------|------------------|---------------|-------|-------------------|------------------|---------------|-------|
| | REEL QTY | TAPE TYPE | WIDTH / PITCH | CODE | REEL QTY | TAPE TYPE | WIDTH / PITCH | CODE |
| R05 / 0201 MLCC | 15000 | Paper | 8mm/2mm | T | N/A | N/A | | N/A |
| R07 / 0402 MLCC | 10000 | Paper | 8mm/2mm | T | N/A | N/A | | N/A |
| R14 / 0603 MLCC | 4000 | Paper | 8mm/4mm | T | 10000 | Paper | 8mm/4mm | R |
| R15 / 0805 MLCC | 4000 / 3000 | Paper / Embossed | 8mm/4mm | T / E | 10000 | Paper / Embossed | 8mm/4mm | R / U |
| R18 / 1206 MLCC | 4000 / 3000 | Paper / Embossed | 8mm/4mm | T / E | 10000 | Paper / Embossed | 8mm/4mm | R / U |
| S41 / 1210 MLCC | 2000 - 4000 | Embossed | 8mm/4mm | E | 5000-10000 | Embossed | 8mm/4mm | U |
| R29 / 1808 MLCC | 2000 | Embossed | 12mm/4mm | E | 5000 - 8000 | Embossed | 12mm/4mm | U |
| R30 / 2211 MLCC | 1000 - 2000 | Embossed | 12mm/4mm | E | 2000 - 5000 | Embossed | 12mm/4mm | U |
| S43 / 1812 MLCC | 500 - 1000 | Embossed | 12mm/8mm | E | 3000 - 5000 | Embossed | 12mm/8mm | U |
| S47 / 2220 MLCC | 250 - 1000 | Embossed | 12mm/8mm | E | 2000 - 5000 | Embossed | 12mm/8mm | U |
| S49 / 1825 MLCC | 250 - 1000 | Embossed | 12mm/8mm | E | 2000 - 4000 | Embossed | 12mm/8mm | U |
| S48 / 2225 MLCC | 250 - 1000 | Embossed | 12mm/8mm | E | 2000 - 4000 | Embossed | 12mm/8mm | U |
| X07 / 0402 X2Y | 4000 | Paper | 8mm/2mm | T | 10000 | Paper | 8mm/2mm | R |
| X14 / 0603 X2Y | 4000 | Paper | 8mm/4mm | T | 10000 | Paper | 8mm/4mm | R |
| X15 / 0805 X2Y | 4000 | Embossed | 8mm/4mm | E | 10000 | Embossed | 8mm/4mm | U |
| X18 / 1206 X2Y | 3000 - 4000 | Embossed | 8mm/4mm | E | 10000 | Embossed | 8mm/4mm | U |
| X41 / 1210 X2Y | 2000 - 3000 | Embossed | 8mm/4mm | E | | | | |
| X44 / 1410 X2Y | 1000 - 2000 | Embossed | 8mm/4mm | E | | | | |
| X43 / 1812 X2Y | 1000 | Embossed | 12mm/8mm | E | | | | |

Actual reel quantities based on part thickness and tape type. Contact sales for reel quantities of specific part numbers.



INDEX OF APPLICATION NOTES AVAILABLE AT JOHANSONDIELECTRICS.COM

GENERAL

Ceramic Capacitor Aging Made Simple
Capacitor Cracks: Still with us after all these years
Understanding Ceramic Capacitors Termination
Capacitors Packaging & Marking
Electrical Characteristics
MLCC Storage and Handling Conditions

APPLICATION NOTES

AC Power Computations for DC Rated Capacitor
Arc Season and Board Design Observations
Corona Effects and their Impact on PWB Layout Induced Hipot failures
DC-DC Converter trends and Output Filter Capacitors
Impact of Pad design and Spacing on AC Breakdown Performance
Pb Free Application Notes
Polyterm® Flexible SMD Termination
Safety Certified Application Notes
Sn/Pb SMT Application Notes
Soldering and Handling Precautions for Large Form Capacitors and Planar Arrays
Tantalum Replacement MLC's and ESR Curves

PROCESSING

Foward/Backward Process Compatability
Pb Free Application Notes
Peak Reflow times, Temperature and the Impact of MSL
Tin Wisker Testing

EMI APPLICATION NOTES

Amplifier Decoupling: EMI vs MLCC
GSM RFI Supression with EMI Filters
EMI Filter Evaluation and PCB Design Guide
Improve Instrument Amplifier Performance with EMI optimized input filter
EMI DC Motor Filtering Basics
EMI Power Bypass Mounting
EMI SerDes Bypass Example



Your Technology Partner



High Voltage

High Capacitance



EMI Filters

AC Safety



High Temperature

AC Power



Planar Arrays &
Discodials

SMPS &
Leaded



Custom Solutions



UNITED STATES:

HEADQUARTERS
4001 Calle Tecate,
Camarillo CA 93012
TEL (805) 389-1166

<https://www.johansondielectrics.com>

HONG KONG:

JOHANSON HONG KONG, LTD.
Unit 812, Heng Ngai Jewelry Ctr.,
44 Hok Yuen Street East, Hunghom,
Kowloon, Hong Kong
TEL +852 2334 6310

asiasales@johansondielectrics.com

Looking for pricing, stock, or lifecycle information?

Click below to explore more details on WIN SOURCE:

⊖ [View 202R18W102MV4E on WIN SOURCE](#)

⊖ [Johanson Dielectrics Inc. Information](#)

Optimize Your Supply Chain with WIN SOURCE Solutions

- ✓ Global Sourcing Solution
- ✓ Obsolete Management
- ✓ Cost Control Management
- ✓ Shortage Management
- ✓ Alternative Solution
- ✓ Excess Inventory Management