



**THE DATASHEET OF
1SMA5926BT3**



1SMA59xxBT3 Series, SZ1SMA59xxBT3G Series

1.5 Watt Plastic Surface Mount Zener Voltage Regulators

This complete new line of 1.5 Watt Zener Diodes offers the following advantages.

Features

- Standard Zener Breakdown Voltage Range – 3.3 V to 68 V
- ESD Rating of Class 3 (>16 kV) per Human Body Model
- Flat Handling Surface for Accurate Placement
- Package Design for Top Slide or Bottom Circuit Board Mounting
- Low Profile Package
- Ideal Replacement for MELF Packages
- AEC-Q101 Qualified and PPAP Capable – SZ1SMA59xxBT3G
- SZ Prefix for Automotive and Other Applications Requiring Unique Site and Control Change Requirements
- Pb-Free Packages are Available

Mechanical Characteristics:

CASE: Void-free, transfer-molded plastic

FINISH: All external surfaces are corrosion resistant with readily solderable leads

MAXIMUM CASE TEMPERATURE FOR SOLDERING PURPOSES:
260°C for 10 seconds

POLARITY: Cathode indicated by molded polarity notch or cathode band

FLAMMABILITY RATING: UL 94 V-0 @ 0.125 in

MAXIMUM RATINGS

Rating	Symbol	Value	Unit
DC Power Dissipation @ $T_L = 75^\circ\text{C}$, Measured Zero Lead Length (Note 1) Derate above 75°C	P_D	1.5 20	W mW/ $^\circ\text{C}$
Thermal Resistance, Junction-to-Lead	$R_{\theta JL}$	50	$^\circ\text{C}/\text{W}$
DC Power Dissipation @ $T_A = 25^\circ\text{C}$ (Note 2) Derate above 25°C	P_D	0.5 4.0	W mW/ $^\circ\text{C}$
Thermal Resistance, Junction-to-Ambient	$R_{\theta JA}$	250	$^\circ\text{C}/\text{W}$
Operating and Storage Temperature Range	T_J, T_{stg}	-65 to +150	$^\circ\text{C}$

Stresses exceeding Maximum Ratings may damage the device. Maximum Ratings are stress ratings only. Functional operation above the Recommended Operating Conditions is not implied. Extended exposure to stresses above the Recommended Operating Conditions may affect device reliability.

1. 1 in square copper pad, FR-4 board.
2. FR-4 Board, using ON Semiconductor minimum recommended footprint.



ON Semiconductor®

<http://onsemi.com>

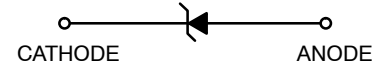

SMA
CASE 403D
PLASTIC

MARKING DIAGRAM



- 8xxB = Device Code (Refer to page 2)
- A = Assembly Location
- Y = Year
- WW = Work Week
- = Pb-Free Package

ORDERING INFORMATION

Device	Package	Shipping†
1SMA59xxBT3	SMA	5000 / Tape & Reel
1SMA59xxBT3G	SMA (Pb-Free)	5000 / Tape & Reel
SZ1SMA59xxBT3G	SMA (Pb-Free)	5000 / Tape & Reel

†For information on tape and reel specifications, including part orientation and tape sizes, please refer to our Tape and Reel Packaging Specifications Brochure, BRD8011/D.

DEVICE MARKING INFORMATION

See specific marking information in the device marking column of the Electrical Characteristics table on page 2 of this data sheet.

1SMA59xxBT3 Series, SZ1SMA59xxBT3G Series

ELECTRICAL CHARACTERISTICS ($T_A = 25^\circ\text{C}$ unless otherwise noted, $V_F = 1.5\text{ V Max.}$ @ $I_F = 200\text{ mA}$ for all types)

Symbol	Parameter
V_Z	Reverse Zener Voltage @ I_{ZT}
I_{ZT}	Reverse Current
Z_{ZT}	Maximum Zener Impedance @ I_{ZT}
I_{ZK}	Reverse Current
Z_{ZK}	Maximum Zener Impedance @ I_{ZK}
I_R	Reverse Leakage Current @ V_R
V_R	Reverse Voltage
I_F	Forward Current
V_F	Forward Voltage @ I_F
I_{ZM}	Maximum DC Zener Current

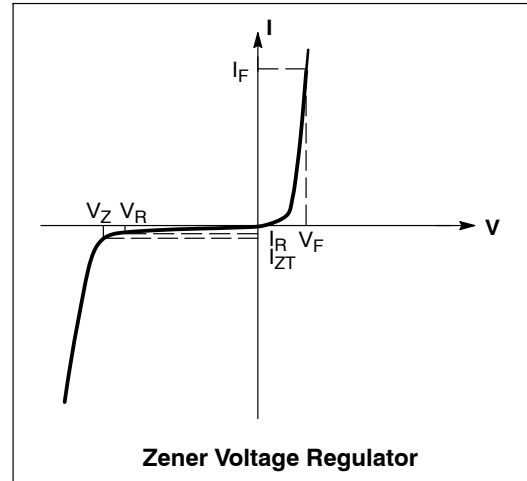

ELECTRICAL CHARACTERISTICS ($T_A = 25^\circ\text{C}$ unless otherwise noted, $V_F = 1.5\text{ V Max.}$ @ $I_F = 200\text{ mA}$ for all types)

Device* (Note 3)	Device Marking	Zener Voltage (Note 4)				Zener Impedance			Leakage Current		I_{ZM}
		V_Z (Volts)			@ I_{ZT}	Z_{ZT} @ I_{ZT}	Z_{ZK} @ I_{ZK}	I_R @ V_R			
		Min	Nom	Max	mA	Ω	Ω	mA	μA	Volts	
SZ/1SMA5913BT3, G	813B	3.13	3.3	3.47	113.6	10	500	1.0	50	1.0	455
1SMA5914BT3, G	814B	3.42	3.6	3.78	104.2	9.0	500	1.0	35.5	1.0	417
SZ/1SMA5915BT3, G	815B	3.70	3.9	4.10	96.1	7.5	500	1.0	12.5	1.0	385
SZ/1SMA5916BT3, G	816B	4.08	4.3	4.52	87.2	6.0	500	1.0	2.5	1.0	349
SZ/1SMA5917BT3, G	817B	4.46	4.7	4.94	79.8	5.0	500	1.0	2.5	1.5	319
SZ/1SMA5918BT3, G	818B	4.84	5.1	5.36	73.5	4.0	350	1.0	2.5	2.0	294
SZ/1SMA5919BT3, G	819B	5.32	5.6	5.88	66.9	2.0	250	1.0	2.5	3.0	268
SZ/1SMA5920BT3, G	820B	5.89	6.2	6.51	60.5	2.0	200	1.0	2.5	4.0	242
SZ/1SMA5921BT3, G	821B	6.46	6.8	7.14	55.1	2.5	200	1.0	2.5	5.2	221
SZ/1SMA5922BT3, G	822B	7.12	7.5	7.88	50	3.0	400	0.5	2.5	6.0	200
SZ/1SMA5923BT3, G	823B	7.79	8.2	8.61	45.7	3.5	400	0.5	2.5	6.5	183
SZ/1SMA5924BT3, G	824B	8.64	9.1	9.56	41.2	4.0	500	0.5	2.5	7.0	165
SZ/1SMA5925BT3, G	825B	9.5	10	10.5	37.5	4.5	500	0.25	2.5	8.0	150
1SMA5926BT3, G	826B	10.45	11	11.55	34.1	5.5	550	0.25	0.5	8.4	136
SZ/1SMA5927BT3, G	827B	11.4	12	12.6	31.2	6.5	550	0.25	0.5	9.1	125
SZ/1SMA5928BT3, G	828B	12.35	13	13.65	28.8	7.0	550	0.25	0.5	9.9	115
SZ/1SMA5929BT3, G	829B	14.25	15	15.75	25	9.0	600	0.25	0.5	11.4	100
SZ/1SMA5930BT3, G	830B	15.2	16	16.8	23.4	10	600	0.25	0.5	12.2	94
SZ/1SMA5931BT3, G	831B	17.1	18	18.9	20.8	12	650	0.25	0.5	13.7	83
SZ/1SMA5932BT3, G	832B	19	20	21	18.7	14	650	0.25	0.5	15.2	75
SZ/1SMA5933BT3, G	833B	20.9	22	23.1	17	17.5	650	0.25	0.5	16.7	68
SZ/1SMA5934BT3, G	834B	22.8	24	25.2	15.6	19	700	0.25	0.5	18.2	63
SZ/1SMA5935BT3, G	835B	25.65	27	28.35	13.9	23	700	0.25	0.5	20.6	56
SZ/1SMA5936BT3, G	836B	28.5	30	31.5	12.5	26	750	0.25	0.5	22.8	50
SZ/1SMA5937BT3, G	837B	31.35	33	34.65	11.4	33	800	0.25	0.5	25.1	45
SZ/1SMA5938BT3, G	838B	34.2	36	37.8	10.4	38	850	0.25	0.5	27.4	42
SZ/1SMA5939BT3, G	839B	37.05	39	40.95	9.6	45	900	0.25	0.5	29.7	38
SZ/1SMA5940BT3, G	840B	40.85	43	45.15	8.7	53	950	0.25	0.5	32.7	35
SZ/1SMA5941BT3, G	841B	44.65	47	49.35	8.0	67	1000	0.25	0.5	35.8	32
SZ/1SMA5942BT3, G	842B	48.45	51	53.55	7.3	70	1100	0.25	0.5	38.8	29
SZ/1SMA5943BT3, G	843B	53.2	56	58.8	6.7	86	1300	0.25	0.5	42.6	27
1SMA5944BT3, G	844B	58.9	62	65.1	6.0	100	1500	0.25	0.5	47.1	24
SZ/1SMA5945BT3, G	845B	64.6	68	71.4	5.5	120	1700	0.25	0.5	51.7	22

3. Tolerance and Voltage Regulation Designation – The type number listed indicates a tolerance of $\pm 5\%$.

4. V_Z limits are to be guaranteed at thermal equilibrium.

* The "G" suffix indicates Pb-Free package available.

1SMA59xxBT3 Series, SZ1SMA59xxBT3G Series

RATING AND TYPICAL CHARACTERISTIC CURVES ($T_A = 25^\circ\text{C}$)

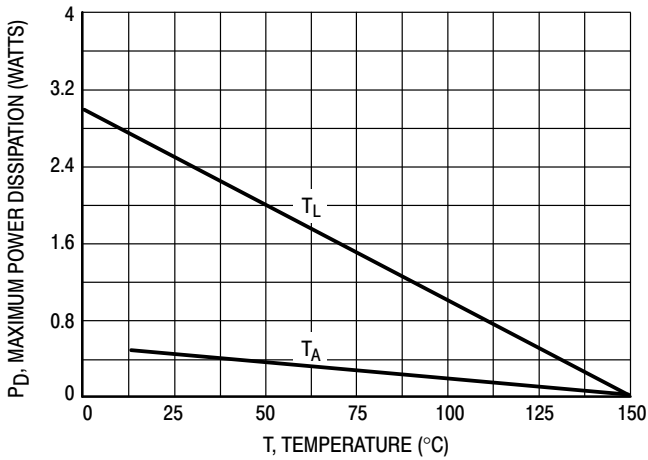

Figure 1. Steady State Power Derating

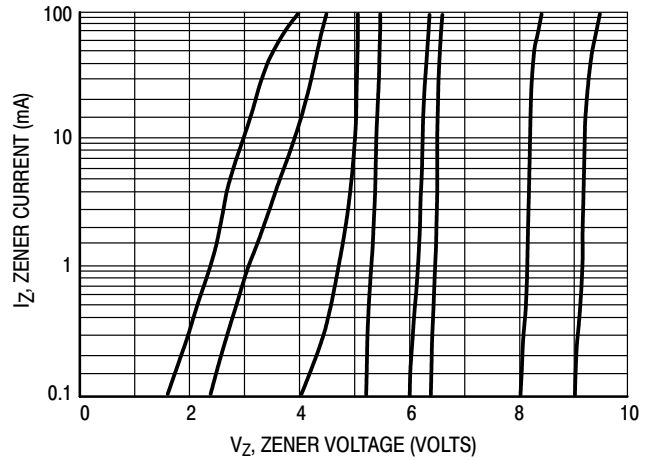

Figure 2. V_Z - 3.3 thru 10 Volts

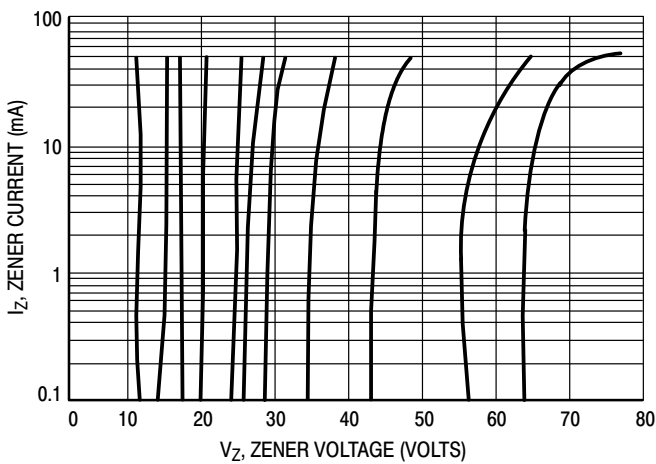

Figure 3. $V_Z = 12$ thru 68 Volts

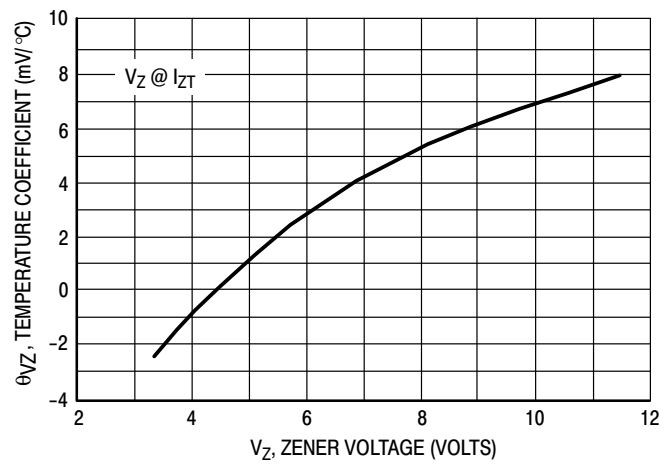

Figure 4. Zener Voltage - 3.3 to 12 Volts

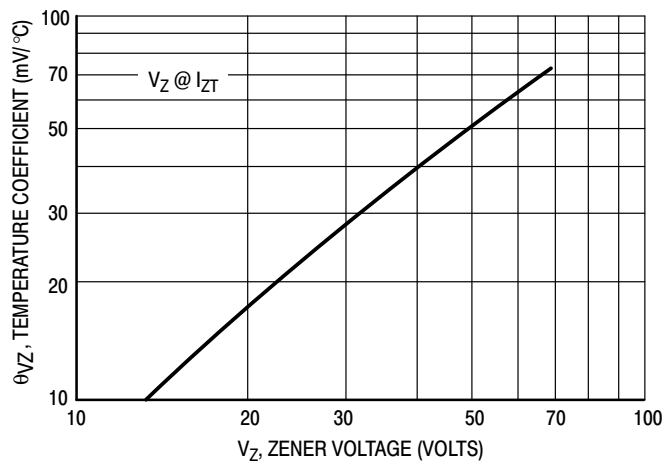

Figure 5. Zener Voltage - 12 to 68 Volts

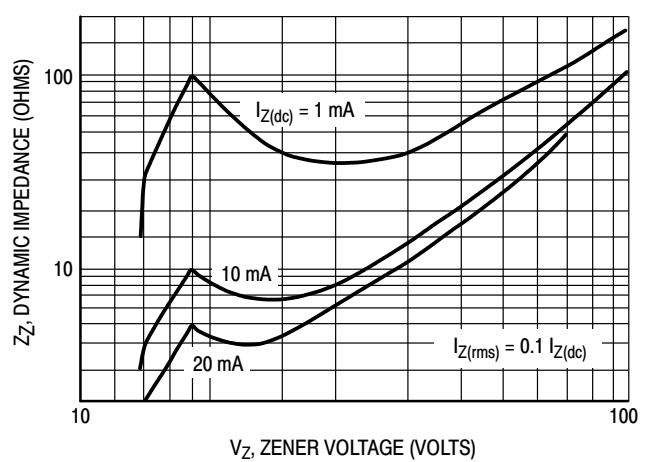

Figure 6. Effect of Zener Voltage

1SMA59xxBT3 Series, SZ1SMA59xxBT3G Series

RATING AND TYPICAL CHARACTERISTIC CURVES ($T_A = 25^\circ\text{C}$)

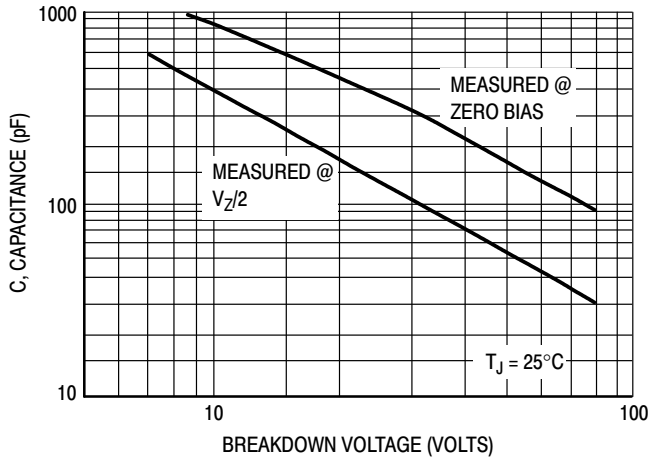

Figure 7. Capacitance Curve

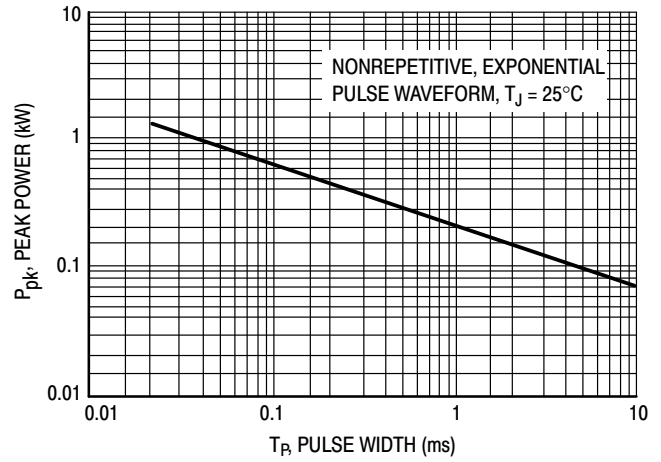

Figure 8. Typical Pulse Rating Curve

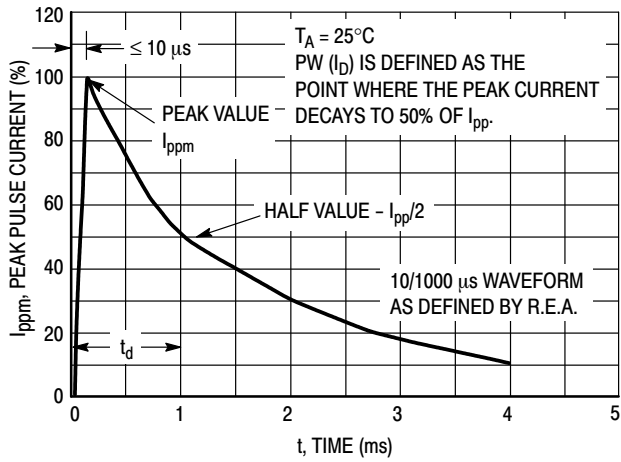

Figure 9. Pulse Waveform

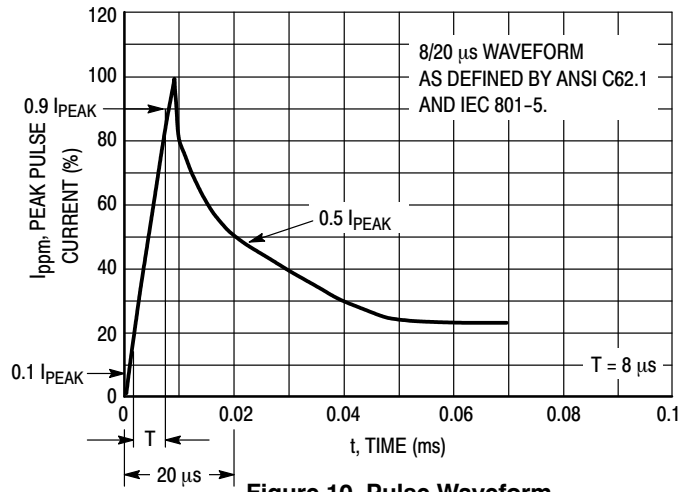
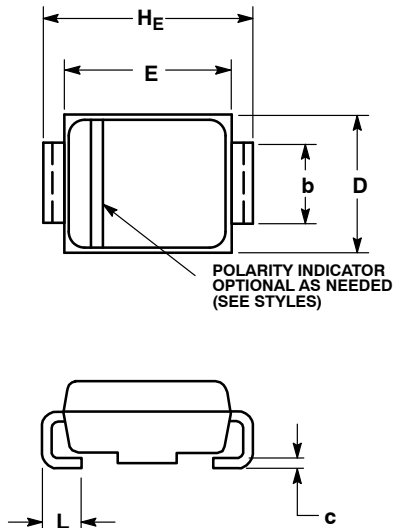

Figure 10. Pulse Waveform

1SMA59xxBT3 Series, SZ1SMA59xxBT3G Series

PACKAGE DIMENSIONS

SMA CASE 403D-02 ISSUE F



- NOTES:
1. DIMENSIONING AND TOLERANCING PER ANSI Y14.5M, 1982.
 2. CONTROLLING DIMENSION: INCH.
 3. 403D-01 OBSOLETE, NEW STANDARD IS 403D-02.

DIM	MILLIMETERS			INCHES		
	MIN	NOM	MAX	MIN	NOM	MAX
A	1.97	2.10	2.20	0.078	0.083	0.087
A1	0.05	0.10	0.15	0.002	0.004	0.006
b	1.27	1.45	1.63	0.050	0.057	0.064
c	0.15	0.28	0.41	0.006	0.011	0.016
D	2.29	2.60	2.92	0.090	0.103	0.115
E	4.06	4.32	4.57	0.160	0.170	0.180
HE	4.83	5.21	5.59	0.190	0.205	0.220
L	0.76	1.14	1.52	0.030	0.045	0.060

- STYLE 1:
PIN 1. CATHODE (POLARITY BAND)
2. ANODE

SOLDERING FOOTPRINT*

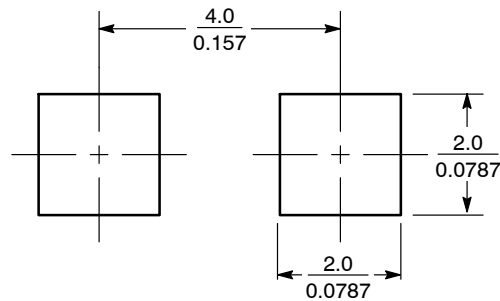

SCALE 8:1 $\left(\frac{\text{mm}}{\text{inches}}\right)$

*For additional information on our Pb-Free strategy and soldering details, please download the ON Semiconductor Soldering and Mounting Techniques Reference Manual, SOLDERRM/D.

ON Semiconductor and  are registered trademarks of Semiconductor Components Industries, LLC (SCILLC). SCILLC reserves the right to make changes without further notice to any products herein. SCILLC makes no warranty, representation or guarantee regarding the suitability of its products for any particular purpose, nor does SCILLC assume any liability arising out of the application or use of any product or circuit, and specifically disclaims any and all liability, including without limitation special, consequential or incidental damages. "Typical" parameters which may be provided in SCILLC data sheets and/or specifications can and do vary in different applications and actual performance may vary over time. All operating parameters, including "Typicals" must be validated for each customer application by customer's technical experts. SCILLC does not convey any license under its patent rights nor the rights of others. SCILLC products are not designed, intended, or authorized for use as components in systems intended for surgical implant into the body, or other applications intended to support or sustain life, or for any other application in which the failure of the SCILLC product could create a situation where personal injury or death may occur. Should Buyer purchase or use SCILLC products for any such unintended or unauthorized application, Buyer shall indemnify and hold SCILLC and its officers, employees, subsidiaries, affiliates, and distributors harmless against all claims, costs, damages, and expenses, and reasonable attorney fees arising out of, directly or indirectly, any claim of personal injury or death associated with such unintended or unauthorized use, even if such claim alleges that SCILLC was negligent regarding the design or manufacture of the part. SCILLC is an Equal Opportunity/Affirmative Action Employer. This literature is subject to all applicable copyright laws and is not for resale in any manner.

PUBLICATION ORDERING INFORMATION

LITERATURE FULFILLMENT:
Literature Distribution Center for ON Semiconductor
P.O. Box 5163, Denver, Colorado 80217 USA
Phone: 303-675-2175 or 800-344-3860 Toll Free USA/Canada
Fax: 303-675-2176 or 800-344-3867 Toll Free USA/Canada
Email: orderlit@onsemi.com

N. American Technical Support: 800-282-9855 Toll Free
USA/Canada
Europe, Middle East and Africa Technical Support:
Phone: 421 33 790 2910
Japan Customer Focus Center
Phone: 81-3-5817-1050

ON Semiconductor Website: www.onsemi.com
Order Literature: <http://www.onsemi.com/orderlit>
For additional information, please contact your local
Sales Representative

Looking for pricing, stock, or lifecycle information?

Click below to explore more details on WIN SOURCE:

 [View 1SMA5926BT3 on WIN SOURCE](#)

 [ON Semiconductor](#) Information

Optimize Your Supply Chain with WIN SOURCE Solutions

-  Global Sourcing Solution
-  Obsolete Management
-  Cost Control Management
-  Shortage Management
-  Alternative Solution
-  Excess Inventory Management