



# THE DATASHEET OF BAR81



### Silicon RF Switching Diode

- Designed for use in shunt configuration in high performance RF switches
- High shunt signal isolation
- Low shunt insertion loss
- Optimized for short - open transformation using  $\lambda/4$  lines
- Pb-free (RoHS compliant) package



### BAR81W

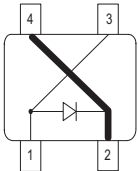

Type	Package	Configuration	$L_S$ (nH)	Marking
BAR81W	SOT343	single shunt-diode	0.15*	BBs

\* series inductance chip to ground

### Maximum Ratings at $T_A = 25^\circ\text{C}$ , unless otherwise specified

Parameter	Symbol	Value	Unit
Diode reverse voltage	$V_R$	30	V
Forward current	$I_F$	100	mA
Total power dissipation $T_S \leq 138^\circ\text{C}$	$P_{\text{tot}}$	100	mW
Junction temperature	$T_j$	150	°C
Operating temperature range	$T_{\text{op}}$	-55 ... 125	
Storage temperature	$T_{\text{stg}}$	-55 ... 150	

### Thermal Resistance

Parameter	Symbol	Value	Unit
Junction - soldering point <sup>1)</sup>	$R_{\text{thJS}}$	$\leq 120$	K/W

<sup>1)</sup>For calculation of  $R_{\text{thJA}}$  please refer to Application Note Thermal Resistance

**Electrical Characteristics at  $T_A = 25^\circ\text{C}$ , unless otherwise specified**

Parameter	Symbol	Values			Unit
		min.	typ.	max.	
<b>DC Characteristics</b>					
Reverse current $V_R = 20\text{ V}$	$I_R$	-	-	20	nA
Forward voltage $I_F = 100\text{ mA}$	$V_F$	-	0.93	1	V

**AC Characteristics**

Diode capacitance $V_R = 1\text{ V}, f = 1\text{ MHz}$ $V_R = 3\text{ V}, f = 1\text{ MHz}$	$C_T$	-	0.6	1	pF
Forward resistance $I_F = 5\text{ mA}, f = 100\text{ MHz}$	$r_f$	-	0.7	1	$\Omega$
Charge carrier life time $I_F = 10\text{ mA}, I_R = 6\text{ mA}$ , measured at $I_R = 3\text{ mA}$ , $R_L = 100\ \Omega$	$\tau_{rr}$	-	80	-	ns
I-region width	$W_I$	-	3.5	-	$\mu\text{m}$
Shunt Insertion loss <sup>1)</sup> $I_F = 10\text{ mA}, f = 1.89\text{ GHz}$	$I_L$	-	30	-	dB
Shunt isolation <sup>1)</sup> $V_R = 3\text{ V}, f = 1.89\text{ GHz}$	$I_{SO}$	-	0.7	-	

**Configuration of the shunt-diode**

- A perfect ground is essential for optimum isolation
- The anode pins should be used as passage for RF

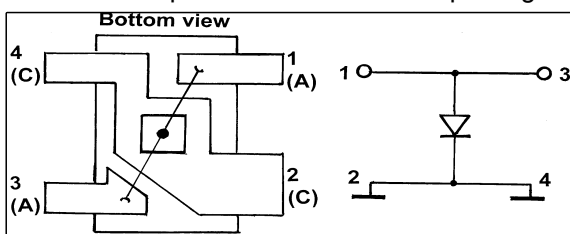
<sup>1</sup>For more information please refer to Application Note 049.

**Diode capacitance  $C_T = f(V_R)$**

$f = \text{Parameter}$

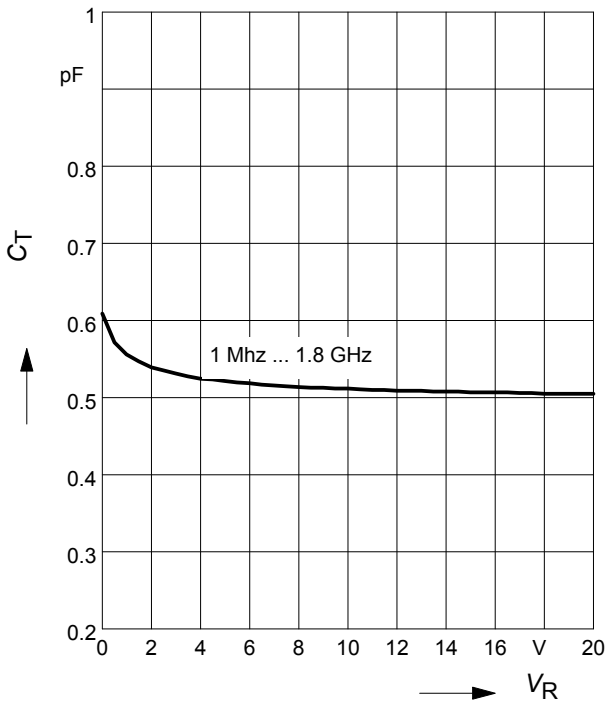

**Reverse parallel resistance  $R_P = f(V_R)$**

$f = \text{Parameter}$

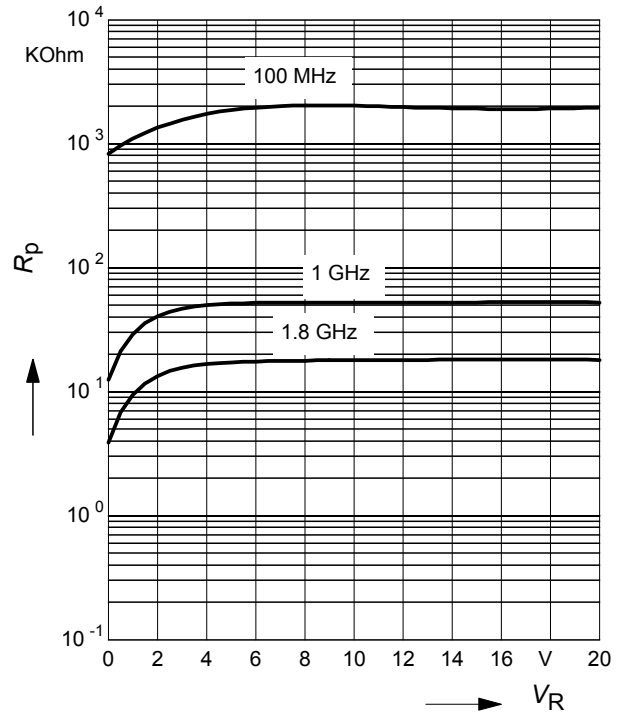

**Forward resistance  $r_f = f(I_F)$**

$f = 100\text{MHz}$

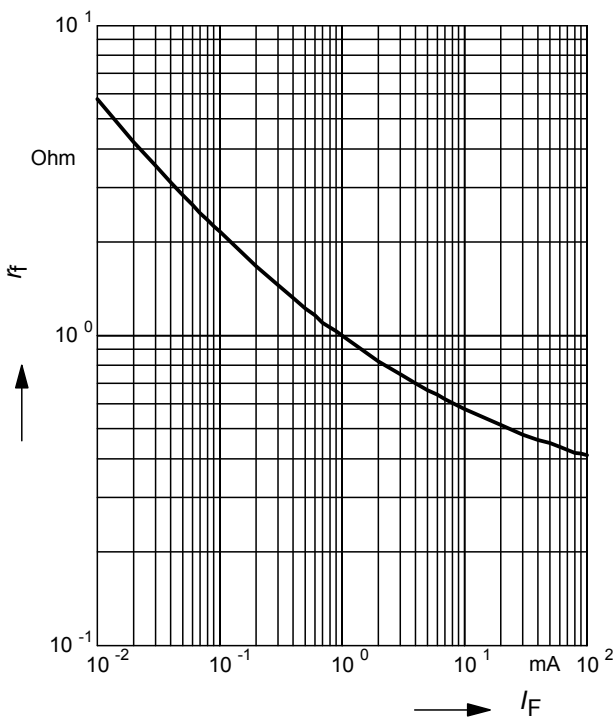

**Forward current  $I_F = f(V_F)$**

$T_A = \text{Parameter}$

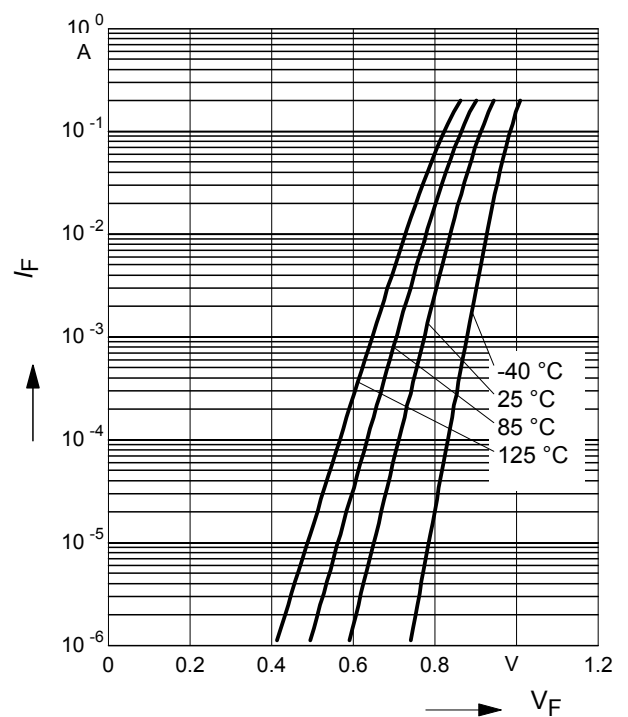

**Forward current  $I_F = f(T_S)$**

BAR81W

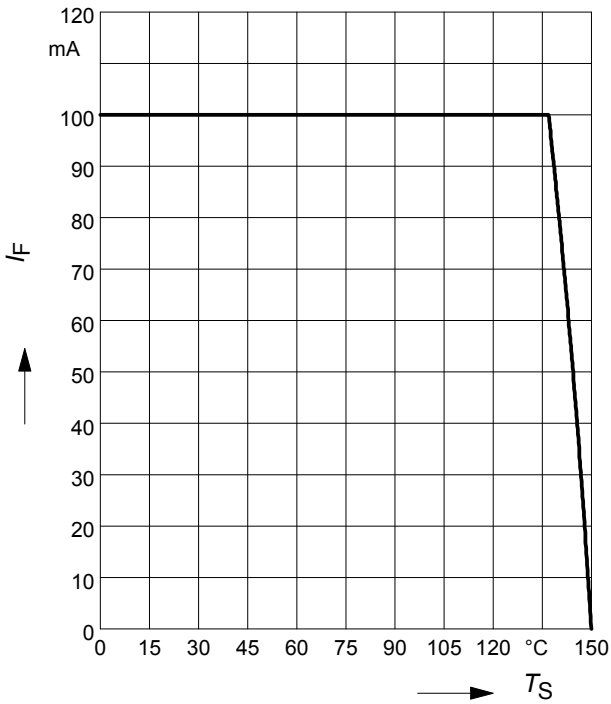

**Permissible Puls Load  $R_{thJS} = f(t_p)$**

BAR81W

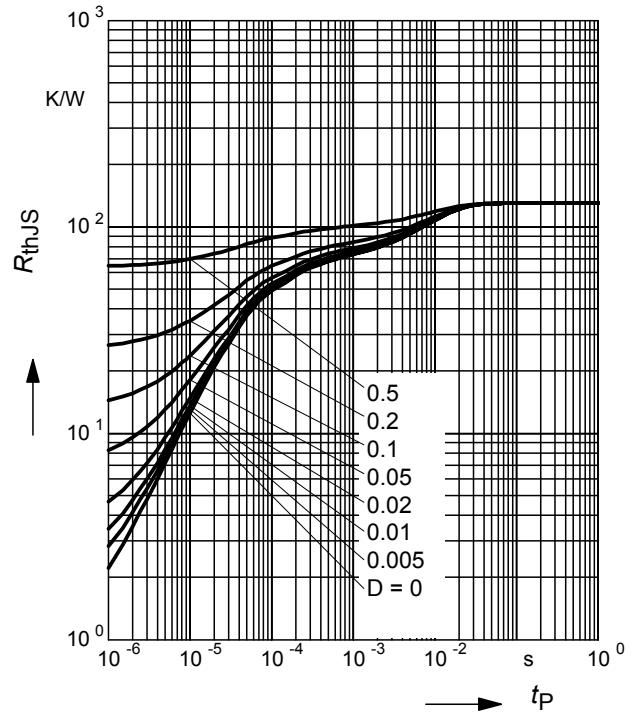

**Permissible Pulse Load**

$I_{Fmax} / I_{FDC} = f(t_p)$  BAR81W

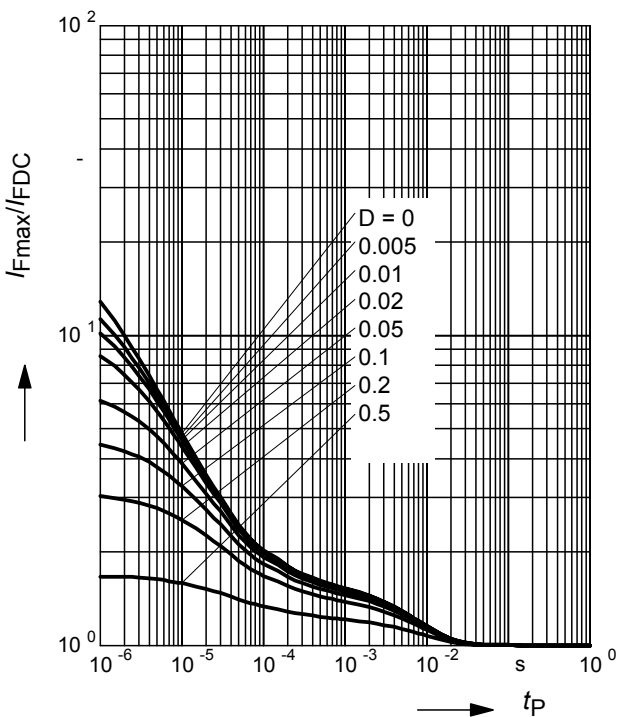

Package Outline

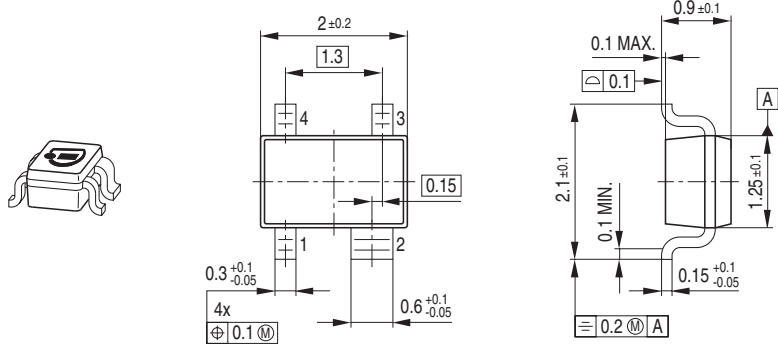

Foot Print

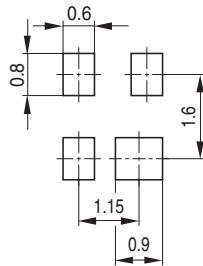

Marking Layout (Example)

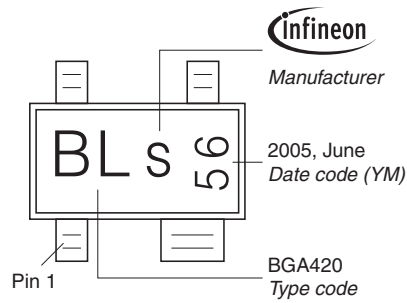

Standard Packing

Reel ø180 mm = 3.000 Pieces/Reel  
 Reel ø330 mm = 10.000 Pieces/Reel

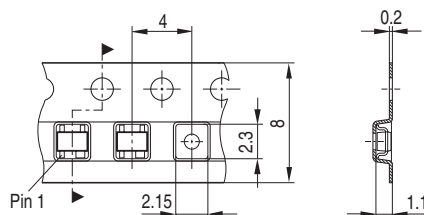

**Edition 2009-11-16**

**Published by  
Infineon Technologies AG  
81726 Munich, Germany**

**© 2009 Infineon Technologies AG  
All Rights Reserved.**

### **Legal Disclaimer**

The information given in this document shall in no event be regarded as a guarantee of conditions or characteristics. With respect to any examples or hints given herein, any typical values stated herein and/or any information regarding the application of the device, Infineon Technologies hereby disclaims any and all warranties and liabilities of any kind, including without limitation, warranties of non-infringement of intellectual property rights of any third party.

### **Information**

For further information on technology, delivery terms and conditions and prices, please contact the nearest Infineon Technologies Office ([www.infineon.com](http://www.infineon.com)).



### **Warnings**

Due to technical requirements, components may contain dangerous substances. For information on the types in question, please contact the nearest Infineon Technologies Office.

Infineon Technologies components may be used in life-support devices or systems only with the express written approval of Infineon Technologies, if a failure of such components can reasonably be expected to cause the failure of that life-support device or system or to affect the safety or effectiveness of that device or system. Life support devices or systems are intended to be implanted in the human body or to support and/or maintain and sustain and/or protect human life. If they fail, it is reasonable to assume that the health of the user or other persons may be endangered.

## Looking for pricing, stock, or lifecycle information?

Click below to explore more details on WIN SOURCE:

-  [View BAR81 on WIN SOURCE](#)
-  [Infineon Technologies Information](#)

## Optimize Your Supply Chain with WIN SOURCE Solutions

-  Global Sourcing Solution
-  Obsolete Management
-  Cost Control Management
-  Shortage Management
-  Alternative Solution
-  Excess Inventory Management