

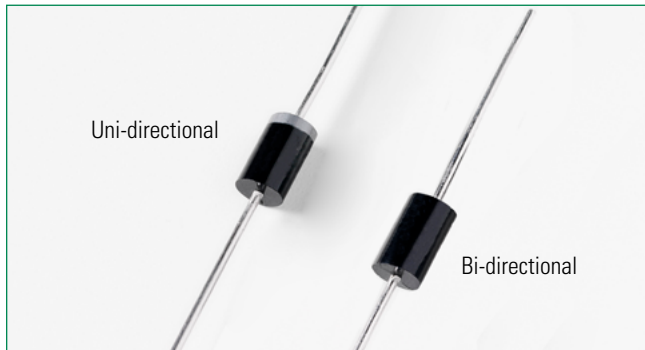



**THE DATASHEET OF
1.5KE18A-B**



1.5KE Series



Agency Approvals

Agency	Agency File Number
	E230531

Maximum Ratings and Thermal Characteristics (T_A = 25°C unless otherwise noted)

Parameter	Symbol	Value	Unit
Peak Pulse Power Dissipation (Fig.2) by 10/1000µs Test Waveform (Fig.4) (Note 1) -Single Die Parts	P _{PPM}	1500	W
Peak Pulse Power Dissipation(Fig.2) by 10/1000µs Test Waveform(Fig.4)(Note 1) -Stacked Die Parts (Note 4)	P _{PPM}	2000	W
Steady State Power Dissipation on Infinite Heat Sink at T _L = 75°C	P _D	6.5	W
Peak Forward Surge Current, 8.3ms Single Half Sine Wave Unidirectional Only (Note 2)	I _{FSM}	200	A
Maximum Instantaneous Forward Voltage at 100A for Unidirectional Only (Note 3)	V _F	3.5/5.0	V
Operating Junction and Storage Temperature Range	T _J , T _{STG}	-55 to 175	°C
Typical Thermal Resistance Junction to Lead	R _{θJL}	15	°C/W
Typical Thermal Resistance Junction to Ambient	R _{θJA}	75	°C/W

Notes:

1. Non-repetitive current pulse, per Fig. 4 and derated above T_J (initial) = 25°C per Fig. 3.
2. Measured on 8.3ms single half sine wave or equivalent square wave, duty cycle=4 per minute maximum.
3. V_F < 3.5V for single die parts and V_F < 5.0V for stacked-die parts.
4. For stacked die component details, please refer to part numbers labeled by * in Electrical Characteristics.

Functional Diagram

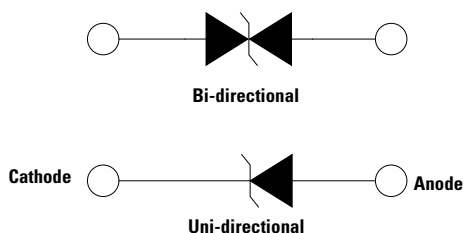

Description

The 1.5KE Series is designed specifically to protect sensitive electronic equipment from voltage transients induced by lightning and other transient voltage events.

Features

- 1500W peak pulse capability at 10/1000µs waveform, repetition rate (duty cycles):0.01 %
- Glass passivated chip junction in DO-201 Package
- Fast response time: typically less than 1.0ps from 0 Volts to BV min
- Excellent clamping capability
- Typical failure mode is short from over-specified voltage or current
- Whisker test is conducted based on JEDEC JESD201A per its table 4a and 4c
- IEC-61000-4-2 ESD 30kV(Air), 30kV (Contact)
- ESD protection of data lines in accordance with IEC 61000-4-2
- EFT protection of data lines in accordance with IEC 61000-4-4
- Low incremental surge resistance
- Typical I_R less than 1µA when V_{BR} min > 12V
- High temperature to reflow soldering guaranteed: 260°C/30sec / 0.375"(9.5mm) lead length, 5 lbs., (2.3kg) tension
- V_{BR} @ T_J = V_{BR} @ 25°C x (1 + αT x (T_J - 25)) (αT: Temperature Coefficient, typical value is 0.1%)
- Plastic package is flammability rated V-0 per Underwriters Laboratories
- Matte tin lead-free plated
- Halogen free and RoHS compliant
- Pb-free E3 means 2nd level interconnect is Pb-free and the terminal finish material is tin(Sn) (IPC/JEDEC J-STD-609A.01)

Applications

TVS devices are ideal for the protection of I/O interfaces, V_{CC} bus and other vulnerable circuits used in telecom, computer, industrial and consumer electronic applications.

Additional Information



Datasheet



Resources



Samples

Electrical Characteristics (T_A=25°C unless otherwise noted)

Part Number (Uni)	Part Number (Bi)	Reverse Stand off Voltage V _R (Volts)	Breakdown Voltage V _{BR} (Volts) @ I _T		Test Current I _T (mA)	Maximum Clamping Voltage V _C @ I _{PP} (Volts)	Maximum Peak Pulse Current I _{PP} (A)	Maximum Reverse Leakage I _R @ V _R (µA)	Agency Approval 
			Min.	Max.					
1.5KE6.8A	1.5KE6.8CA	5.80	6.45	7.14	10	10.5	144.8	1000	X
1.5KE7.5A	1.5KE7.5CA	6.40	7.13	7.88	10	11.3	134.5	500	X
1.5KE8.2A	1.5KE8.2CA	7.02	7.79	8.61	10	12.1	125.6	200	X
1.5KE9.1A	1.5KE9.1CA	7.78	8.65	9.50	1	13.4	113.4	50	X
1.5KE10A	1.5KE10CA	8.55	9.50	10.50	1	14.5	104.8	10	X
1.5KE11A	1.5KE11CA	9.40	10.50	11.60	1	15.6	97.4	5	X
1.5KE12A	1.5KE12CA	10.20	11.40	12.60	1	16.7	91.0	5	X
1.5KE13A	1.5KE13CA	11.10	12.40	13.70	1	18.2	83.5	1	X
1.5KE15A	1.5KE15CA	12.80	14.30	15.80	1	21.2	71.7	1	X
1.5KE16A	1.5KE16CA	13.60	15.20	16.80	1	22.5	67.6	1	X
1.5KE18A	1.5KE18CA	15.30	17.10	18.90	1	25.2	60.3	1	X
1.5KE20A	1.5KE20CA	17.10	19.00	21.00	1	27.7	54.9	1	X
1.5KE22A	1.5KE22CA	18.80	20.90	23.10	1	30.6	49.7	1	X
1.5KE24A	1.5KE24CA	20.50	22.80	25.20	1	33.2	45.8	1	X
1.5KE27A	1.5KE27CA	23.10	25.70	28.40	1	37.5	40.5	1	X
1.5KE30A	1.5KE30CA	25.60	28.50	31.50	1	41.4	36.7	1	X
1.5KE33A	1.5KE33CA	28.20	31.40	34.70	1	45.7	33.3	1	X
1.5KE36A	1.5KE36CA	30.80	34.20	37.80	1	49.9	30.5	1	X
1.5KE39A	1.5KE39CA	33.30	37.10	41.00	1	53.9	28.2	1	X
1.5KE43A	1.5KE43CA	36.80	40.90	45.20	1	59.3	25.6	1	X
1.5KE47A	1.5KE47CA	40.20	44.70	49.40	1	64.8	23.5	1	X
1.5KE51A	1.5KE51CA	43.60	48.50	53.60	1	70.1	21.7	1	X
1.5KE56A	1.5KE56CA	47.80	53.20	58.80	1	77.0	19.7	1	X
1.5KE62A	1.5KE62CA	53.00	58.90	65.10	1	85.0	17.9	1	X
1.5KE68A	1.5KE68CA	58.10	64.60	71.40	1	92.0	16.5	1	X
1.5KE75A	1.5KE75CA	64.10	71.30	78.80	1	103.0	14.8	1	X
1.5KE82A	1.5KE82CA	70.10	77.90	86.10	1	113.0	13.5	1	X
1.5KE91A	1.5KE91CA	77.80	86.50	95.50	1	125.0	12.2	1	X
1.5KE100A	1.5KE100CA	85.50	95.00	105.00	1	137.0	11.1	1	X
1.5KE110A	1.5KE110CA	94.00	105.00	116.00	1	152.0	10.0	1	X
1.5KE120A	1.5KE120CA	102.00	114.00	126.00	1	165.0	9.2	1	X
1.5KE130A	1.5KE130CA	111.00	124.00	137.00	1	179.0	8.5	1	X
1.5KE150A	1.5KE150CA	128.00	143.00	158.00	1	207.0	7.3	1	X
1.5KE160A	1.5KE160CA	136.00	152.00	168.00	1	219.0	6.9	1	X
1.5KE170A	1.5KE170CA	145.00	162.00	179.00	1	234.0	6.5	1	X
1.5KE180A	1.5KE180CA	154.00	171.00	189.00	1	246.0	6.2	1	X
1.5KE200A	1.5KE200CA	171.00	190.00	210.00	1	274.0	5.5	1	X
1.5KE220A	1.5KE220CA	185.00	209.00	231.00	1	328.0	4.6	1	X
1.5KE250A	-	214.00	237.00	263.00	1	344.0	4.4	1	X
-	1.5KE250CA*	214.00	237.00	263.00	1	344.0	5.9	1	X
1.5KE300A*	1.5KE300CA*	256.00	285.00	315.00	1	414.0	4.9	1	X
1.5KE320A*	1.5KE320CA*	273.00	304.00	336.00	1	441.0	4.6	1	X
1.5KE350A*	1.5KE350CA*	300.00	332.00	368.00	1	482.0	4.2	1	X
1.5KE400A*	1.5KE400CA*	342.00	380.00	420.00	1	548.0	3.7	1	X
1.5KE440A*	1.5KE440CA*	376.00	418.00	462.00	1	602.0	3.1	1	X
1.5KE480A*	1.5KE480CA*	408.00	456.00	504.00	1	658.0	3.1	1	-
1.5KE510A*	1.5KE510CA*	434.00	485.00	535.00	1	698.0	2.9	1	-
1.5KE530A*	1.5KE530CA*	451.00	503.50	556.50	1	725.0	2.8	1	-
1.5KE540A*	1.5KE540CA*	460.00	513.00	567.00	1	740.0	2.8	1	-
1.5KE550A*	1.5KE550CA*	468.00	522.50	577.50	1	760.0	2.7	1	-
1.5KE600A*	1.5KE600CA*	512.00	570.00	630.00	1	828.0	2.5	1	-

For bidirectional type having V_R of 10 volts and less, the I_R limit is double.

For parts without A, the V_{BR} is ± 10% and V_C is 5% higher than with A parts, the parts without A are currently available, but not recommended for new designs. The parts with A are preferred.

For stack-die parts, use * to label the part number.

I-V Curve Characteristics

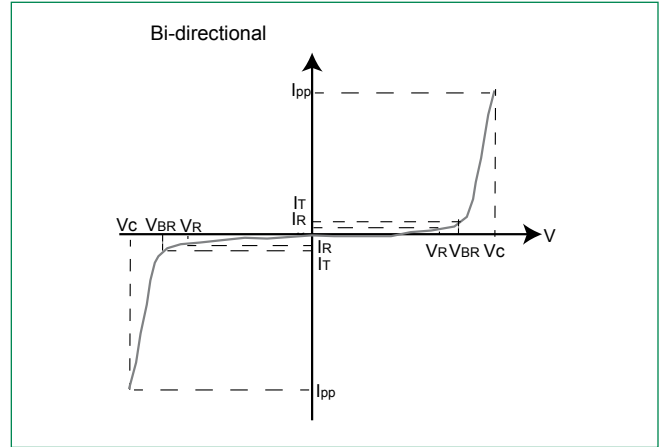
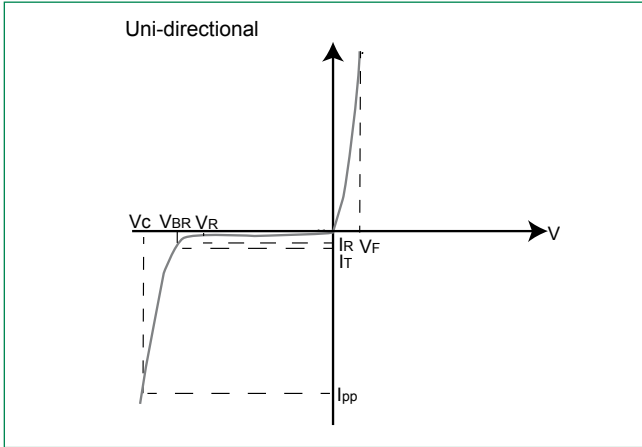

- P_{PPM} Peak Pulse Power Dissipation** – Max power dissipation
- V_R Stand-off Voltage** – Maximum voltage that can be applied to the TVS without operation
- V_{BR} Breakdown Voltage** – Maximum voltage that flows through the TVS at a specified test current (I_r)
- V_C Clamping Voltage** – Peak voltage measured across the TVS at a specified I_{ppm} (peak impulse current)
- I_R Reverse Leakage Current** – Current measured at V_R
- V_F Forward Voltage Drop for Uni-directional**

Ratings and Characteristic Curves ($T_A=25^\circ\text{C}$ unless otherwise noted)

Figure 1 - TVS Transients Clamping Waveform

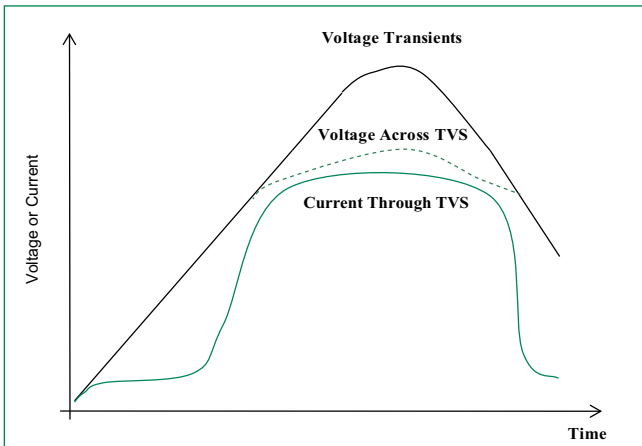
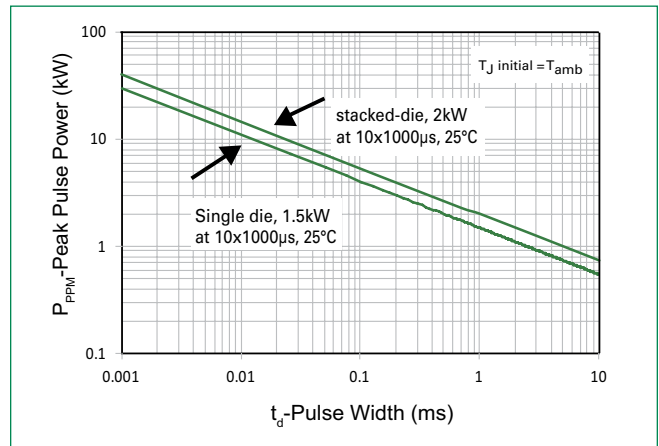

Figure 2 - Peak Pulse Power Rating



Ratings and Characteristic Curves ($T_A=25^\circ\text{C}$ unless otherwise noted) (Continued)

Figure 3 - Peak Pulse Power Derating Curve

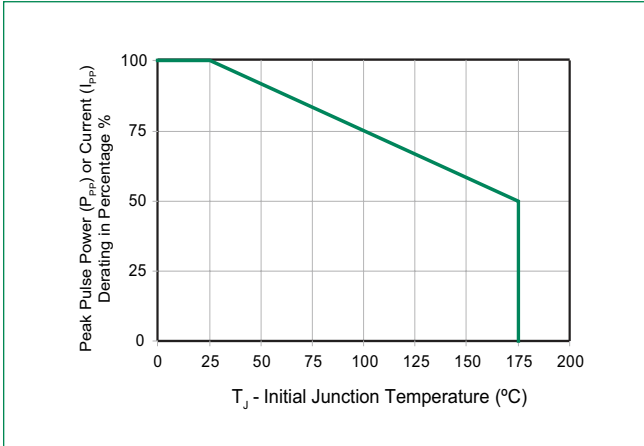

Figure 4 - Pulse Waveform

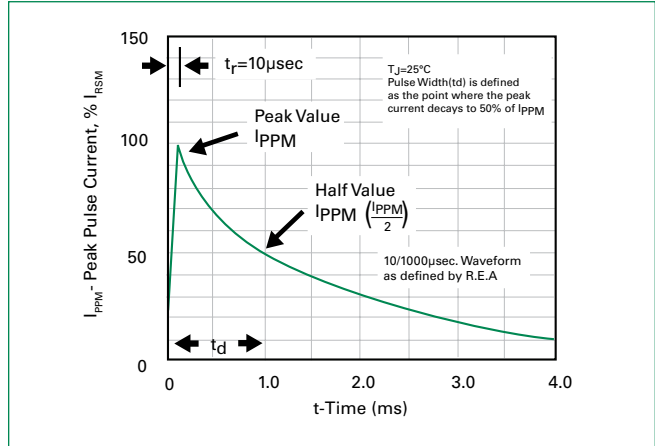

Figure 5 - Typical Junction Capacitance

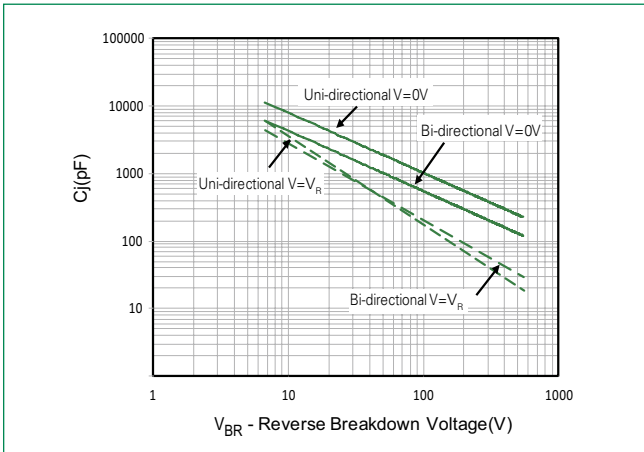

Figure 6 - Typical Transient Thermal Impedance

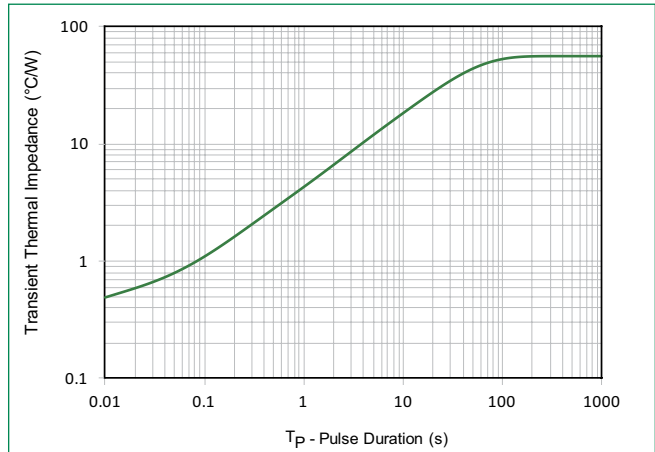

Figure 7 - Maximum Non-Repetitive Peak Forward Surge Current Uni-Directional Only

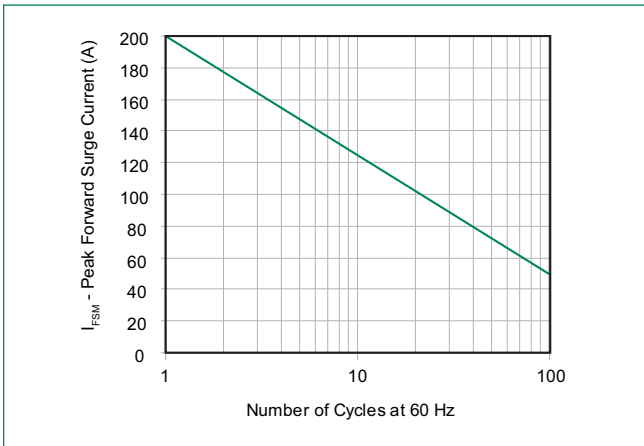
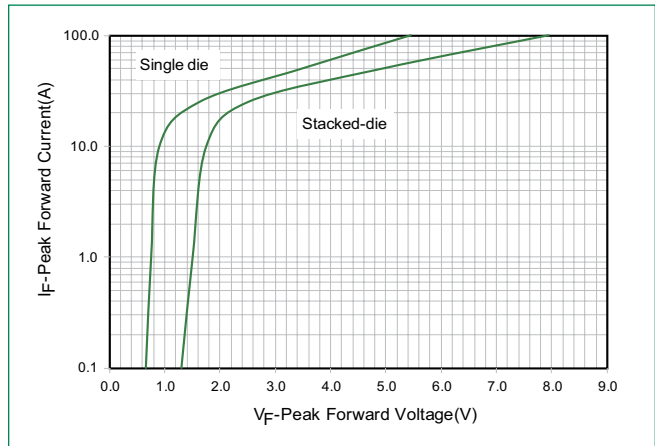
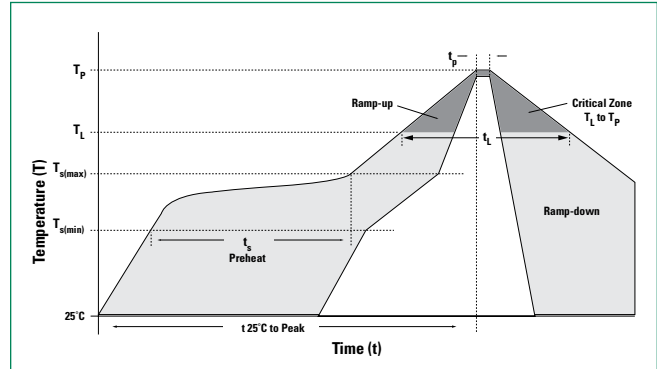

Figure 8 - Peak Forward Voltage Drop vs Peak Forward Current (Typical Values)



Soldering Parameters

Reflow Condition		Lead-free assembly
Pre Heat	- Temperature Min ($T_{s(min)}$)	150°C
	- Temperature Max ($T_{s(max)}$)	200°C
	- Time (min to max) (t_s)	60 – 120 secs
Average ramp up rate (Liquidus Temp (T_L) to peak)		3°C/second max
$T_{s(max)}$ to T_L - Ramp-up Rate		3°C/second max
Reflow	- Temperature (T_L) (Liquidus)	217°C
	- Time (min to max) (t_L)	60 – 150 seconds
Peak Temperature (T_p)		260 ^{+0/-5} °C
Time within 5°C of actual peak Temperature (t_p)		30 seconds max
Ramp-down Rate		6°C/second max
Time 25°C to peak Temperature (T_p)		8 minutes Max.
Do not exceed		260°C



Flow/Wave Soldering (Solder Dipping)

Peak Temperature :	265°C
Dipping Time :	10 seconds
Soldering :	1 time

Physical Specifications

Weight	0.045oz., 1.2g
Case	JEDEC DO-201 molded plastic body over passivated junction.
Polarity	Color band denotes the cathode except Bipolar.
Terminal	Matte Tin axial leads, solderable per JESD22-B102.

Environmental Specifications

High Temp. Storage	JESD22-A103
HTRB	JESD22-A108
Temperature Cycling	JESD22-A104
H3TRB	JESD22-A101
RSH	JESD22-B106

Dimensions

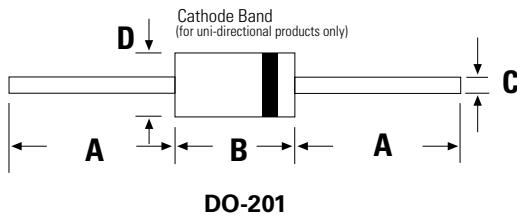

Dimensions	Inches		Millimeters	
	Min	Max	Min	Max
A	1.000	-	25.40	-
B	0.285	0.375	7.20	9.50
C	0.038	0.042	0.96	1.07
D	0.190	0.210	4.80	5.30

Part Numbering System

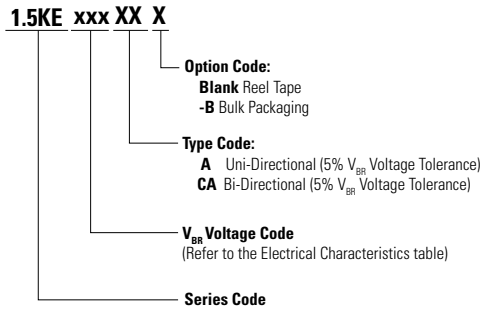

Part Marking System

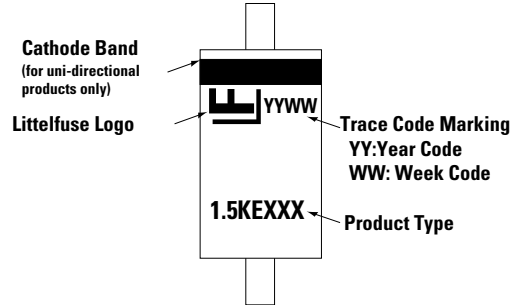

Packaging

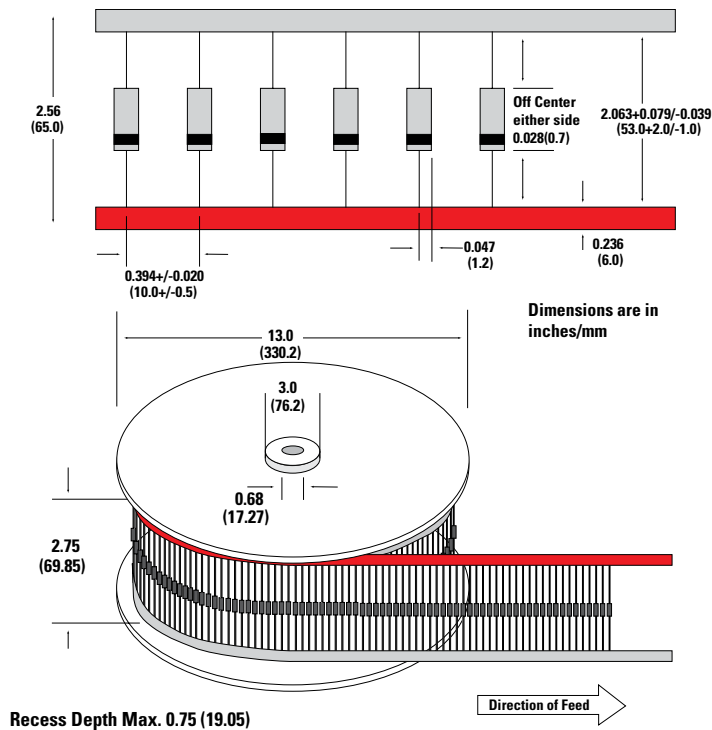

Part Number	Component Package	Quantity	Packaging Option	Packaging Specification
1.5KExxxXX	DO-201	1200	Tape & Reel	EIA STD RS-296
1.5KExxxXX-B	DO-201	500	BULK	Littelfuse Spec.

Tape and Reel Specification



Looking for pricing, stock, or lifecycle information?

Click below to explore more details on WIN SOURCE:

-  [View 1.5KE18A-B on WIN SOURCE](#)
-  [Littelfuse Inc. Information](#)

Optimize Your Supply Chain with WIN SOURCE Solutions

-  Global Sourcing Solution
-  Obsolete Management
-  Cost Control Management
-  Shortage Management
-  Alternative Solution
-  Excess Inventory Management