

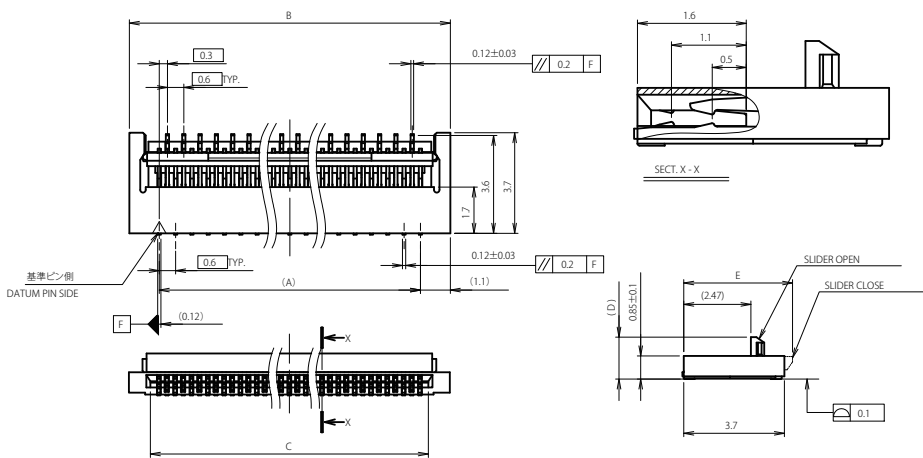

**0.3mm Pitch  
SERIES**

# 6293

0.3mmピッチ RA SMT 上下両接点 ワンタッチロック  
0.3mmPitch RA SMT Dual-sided contact One-touch lock



極数 NO. OF POS.	A	B	C	D	E
9	2.4	4.6	3.0	1.54	4.0
11	3.0	5.2	3.6	1.54	4.0
13	3.6	5.8	4.2	1.54	4.0
15	4.2	6.4	4.8	1.54	4.0
17	4.8	7.0	5.4	1.54	4.0
19	5.4	7.6	6.0	1.54	4.0
21	6.0	8.2	6.6	1.54	4.0
23	6.6	8.8	7.2	1.54	4.0
25	7.2	9.4	7.8	1.54	4.0
27	7.8	10.0	8.4	1.54	4.0
29	8.4	10.6	9.0	1.54	4.0
31	9.0	11.2	9.6	1.54	4.0
33	9.6	11.8	10.2	1.54	4.0
35	10.2	12.4	10.8	1.54	4.0
37	10.8	13.0	11.4	1.54	4.0
39	11.4	13.6	12.0	1.54	4.0
41	12.0	14.2	12.6	1.54	4.0
43	12.6	14.8	13.2	1.54	4.0
45	13.2	15.4	13.8	1.54	4.0
47	13.8	16.0	14.4	1.54	4.0
49	14.4	16.6	15.0	1.54	4.0
51	15.0	17.2	15.6	1.54	4.0
53	15.6	17.8	16.2	2.0	4.5
55	16.2	18.4	16.8	2.0	4.5
57	16.8	19.0	17.4	2.0	4.5
59	17.4	19.6	18.0	2.0	4.5
61	18.0	20.2	18.6	2.0	4.5

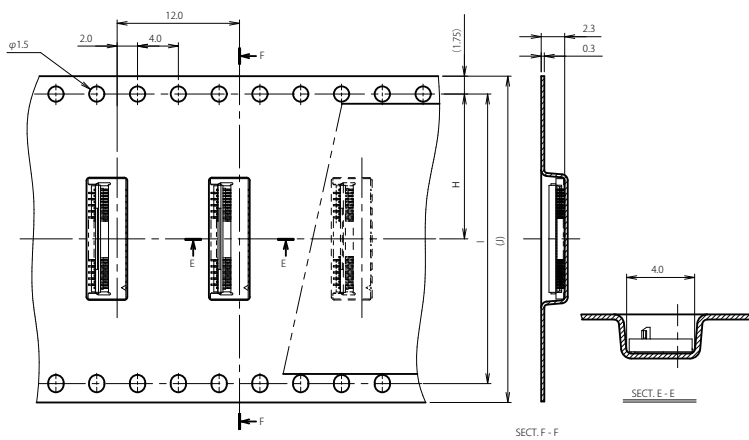
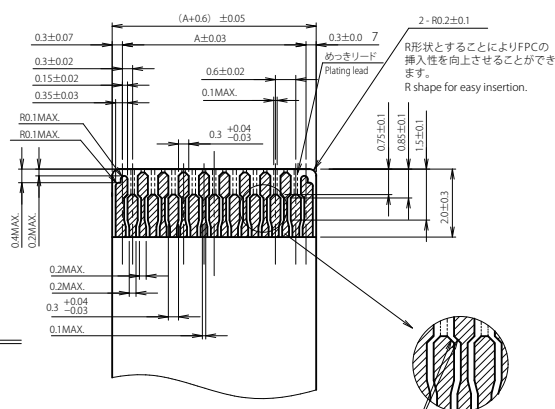
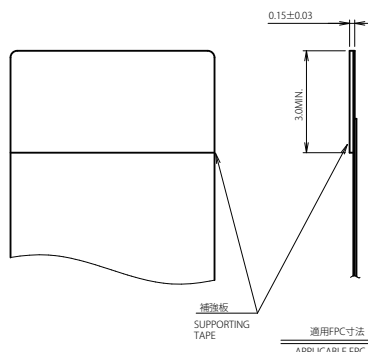
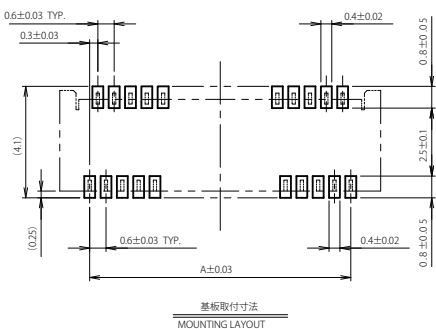

極数 NO. OF POS.	H	I	J
9	7.5	-	16.0
11	7.5	-	16.0
13	7.5	-	16.0
15	7.5	-	16.0
17	11.5	-	24.0
19	11.5	-	24.0
21	11.5	-	24.0
23	11.5	-	24.0
25	11.5	-	24.0
27	11.5	-	24.0
29	11.5	-	24.0
31	11.5	-	24.0
33	14.2	28.4	32.0
35	14.2	28.4	32.0
37	14.2	28.4	32.0
39	14.2	28.4	32.0
41	14.2	28.4	32.0
43	14.2	28.4	32.0
45	14.2	28.4	32.0
47	14.2	28.4	32.0
49	14.2	28.4	32.0
51	14.2	28.4	32.0
53	14.2	28.4	32.0
55	14.2	28.4	32.0
57	14.2	28.4	32.0
59	14.2	28.4	32.0
61	14.2	28.4	32.0

テーパ部分をオーバーラップさせることにより、屈曲時の断線が発生し難くなります。  
For prevention against an open circuit in being bent, the tapered areas shall be laid as indicated.

注文コード ORDERING CODE  
**04 6293 XXX 00X 829+**

**RoHS 対応品**  
RoHS Compliant Product

- 金めっき Au plated
- 6XX 005: 9-51 Positions (Halogen-Free Product)
- 0XX 004: 53-61 Positions
- 極数 NUMBER OF POSITIONS

生産対応可能極数については、営業部にご確認願います。

Feel free to contact our sales department for available numbers of positions.

梱包数量 2000個/リール  
PACKING QUANTITY : 2000 /Reel







## Looking for pricing, stock, or lifecycle information?

Click below to explore more details on WIN SOURCE:

 [View 046293635015829+ on WIN SOURCE](#)

 [AVX Corp/Kyocera Corp](#) Information

## Optimize Your Supply Chain with WIN SOURCE Solutions

-  Global Sourcing Solution
-  Obsolete Management
-  Cost Control Management
-  Shortage Management
-  Alternative Solution
-  Excess Inventory Management