



**THE DATASHEET OF
1PMT5.0AT1**



1PMT5.0AT1G/T3G Series

Zener Transient Voltage Suppressor POWERMITE® Package

The 1PMT5.0AT1G/T3G Series is designed to protect voltage sensitive components from high voltage, high energy transients. Excellent clamping capability, high surge capability, low Zener impedance and fast response time. The advanced packaging technique provides for a highly efficient micro miniature, space saving surface mount with its unique heatsink design. The POWERMITE has the same thermal performance as the SMA while being 50% smaller in footprint area, and delivering one of the lowest height profiles (1.1 mm) in the industry. Because of its small size, it is ideal for use in cellular phones, portable devices, business machines, power supplies and many other industrial/consumer applications.

Specification Features:

- Stand-off Voltage: 5.0 V – 58 V
- Peak Power – 200 W @ 1 ms (1PMT5.0A – 1PMT36A)
– 175 W @ 1 ms (1PMT40A – 1PMT58A)
- Maximum Clamp Voltage @ Peak Pulse Current
- Low Leakage
- Response Time is Typically < 1 ns
- ESD Rating of Class 3 (> 16 kV) per Human Body Model
- Low Profile – Maximum Height of 1.1 mm
- Integral Heatsink/Locking Tabs
- Full Metallic Bottom Eliminates Flux Entrapment
- Small Footprint – Footprint Area of 8.45 mm²
- POWERMITE is JEDEC Registered as DO-216AA
- Lead Orientation in Tape: Cathode (Short) Lead to Sprocket Holes
- Cathode Indicated by Polarity Band
- These Devices are Pb-Free and are RoHS Compliant

Mechanical Characteristics:

CASE: Void-free, transfer-molded, thermosetting plastic

FINISH: All external surfaces are corrosion resistant and leads are readily solderable

MOUNTING POSITION: Any

MAXIMUM CASE TEMPERATURE FOR SOLDERING PURPOSES:
260°C for 10 Seconds



ON Semiconductor®

<http://onsemi.com>

**PLASTIC SURFACE MOUNT
ZENER OVERVOLTAGE
TRANSIENT SUPPRESSOR
5 – 58 V
200 W PEAK POWER**

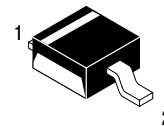
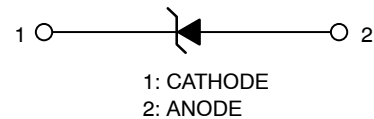

POWERMITE
CASE 457

MARKING DIAGRAM

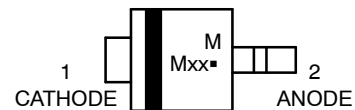

- M = Date Code
- Mxx = Specific Device Code
(See Table on Page 3)
- = Pb-Free Package

ORDERING INFORMATION

Device	Package	Shipping†
1PMTxxAT1G	POWERMITE (Pb-Free)	3,000/Tape & Reel
1PMTxxAT3G	POWERMITE (Pb-Free)	12,000/Tape & Reel

†For information on tape and reel specifications, including part orientation and tape sizes, please refer to our Tape and Reel Packaging Specifications Brochure, BRD8011/D.

1PMT5.0AT1G/T3G Series

MAXIMUM RATINGS

Rating	Symbol	Value	Unit
Maximum P_{pk} Dissipation, (PW-10/1000 μ s) (Note 1) (1PMT5.0A – 1PMT36A)	P_{pk}	200	W
Maximum P_{pk} Dissipation, (PW-10/1000 μ s) (Note 1) (1PMT40A – 1PMT58A)	P_{pk}	175	W
Maximum P_{pk} Dissipation, (PW-8/20 μ s) (Note 1)	P_{pk}	1000	W
DC Power Dissipation @ $T_A = 25^\circ\text{C}$ (Note 2) Derate above 25°C	P_D	500	mW
Thermal Resistance, Junction-to-Ambient	$R_{\theta JA}$	4.0	$\text{mW}/^\circ\text{C}$
Thermal Resistance, Junction-to-Lead (Anode)	$R_{\theta J\text{anode}}$	248	$^\circ\text{C}/\text{W}$
Maximum DC Power Dissipation (Note 3) Thermal Resistance, Junction-to-Tab (Cathode)	P_D $R_{\theta J\text{cathode}}$	3.2 23	W $^\circ\text{C}/\text{W}$
Operating and Storage Temperature Range	T_J, T_{stg}	-55 to +150	$^\circ\text{C}$

Stresses exceeding Maximum Ratings may damage the device. Maximum Ratings are stress ratings only. Functional operation above the Recommended Operating Conditions is not implied. Extended exposure to stresses above the Recommended Operating Conditions may affect device reliability.

1. Nonrepetitive current pulse at $T_A = 25^\circ\text{C}$.
2. Mounted with recommended minimum pad size, DC board FR-4.
3. At Tab (Cathode) temperature, $T_{\text{tab}} = 75^\circ\text{C}$

ELECTRICAL CHARACTERISTICS ($T_A = 25^\circ\text{C}$ unless otherwise noted, $V_F = 3.5\text{ V Max. @ } I_F$ (Note 4) = 35 A)

Symbol	Parameter
I_{PP}	Maximum Reverse Peak Pulse Current
V_C	Clamping Voltage @ I_{PP}
V_{RWM}	Working Peak Reverse Voltage
I_R	Maximum Reverse Leakage Current @ V_{RWM}
V_{BR}	Breakdown Voltage @ I_T
I_T	Test Current
I_F	Forward Current
V_F	Forward Voltage @ I_F

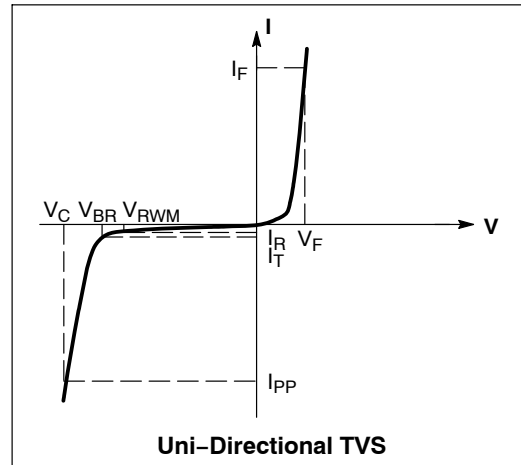

1PMT5.0AT1G/T3G Series

ELECTRICAL CHARACTERISTICS ($T_L = 30^\circ\text{C}$ unless otherwise noted, $V_F = 1.25$ Volts @ 200 mA)

Device*	Marking	V_{RWM}	$V_{BR} @ I_T$ (V) (Note 6)			I_T	$I_R @ V_{RWM}$	$V_C @ I_{PP}$	I_{PP} (A)
		(Note 5)	Min	Nom	Max	(mA)	(μA)	(V)	(Note 7)
1PMT5.0AT1G, T3G	MKE	5.0	6.4	6.7	7.0	10	50	9.2	21.7
1PMT7.0AT1G, T3G	MKM	7.0	7.78	8.2	8.6	10	30	12	16.7
1PMT12AT1G, T3G	MLE	12	13.3	14.0	14.7	1.0	1.0	19.9	10.1
1PMT16AT1G, T3G	MLP	16	17.8	18.75	19.7	1.0	1.0	26	7.7
1PMT18AT1G, T3G	MLT	18	20.0	21.0	22.1	1.0	1.0	29.2	6.8
1PMT22AT1G, T3G	MLX	22	24.4	25.6	26.9	1.0	1.0	35.5	5.6
1PMT24AT1G, T3G	MLZ	24	26.7	28.1	29.5	1.0	1.0	38.9	5.1
1PMT26AT1G, T3G	MME	26	28.9	30.4	31.9	1.0	1.0	42.1	4.8
1PMT28AT1G, T3G	MMG	28	31.1	32.8	34.4	1.0	1.0	45.4	4.4
1PMT30AT1G, T3G	MMK	30	33.3	35.1	36.8	1.0	1.0	48.4	4.1
1PMT33AT1G, T3G	MMM	33	36.7	38.7	40.6	1.0	1.0	53.3	3.8
1PMT36AT1G, T3G	MMP	36	40.0	42.1	44.2	1.0	1.0	58.1	3.4
1PMT40AT1G, T3G	MMR	40	44.4	46.8	49.1	1.0	1.0	64.5	2.7
1PMT48AT1G, T3G	MMX	48	53.3	56.1	58.9	1.0	1.0	77.4	2.3
1PMT51AT1G, T3G	MMZ	51	56.7	59.7	62.7	1.0	1.0	82.4	2.1
1PMT58AT1G, T3G	MNG	58	64.4	67.8	71.2	1.0	1.0	93.6	1.9

4. 1/2 sine wave (or equivalent square wave), PW = 8.3 ms, duty cycle = 4 pulses per minute maximum.

5. A transient suppressor is normally selected according to the Working Peak Reverse Voltage (V_{RWM}) which should be equal to or greater than the DC or continuous peak operating voltage level.

6. V_{BR} measured at pulse test current I_T at ambient temperature of 25°C .

7. Surge current waveform per Figure 2 and derate per Figure 4.

*The "G" suffix indicates Pb-Free package.

1PMT5.0AT1G/T3G Series

TYPICAL PROTECTION CIRCUIT

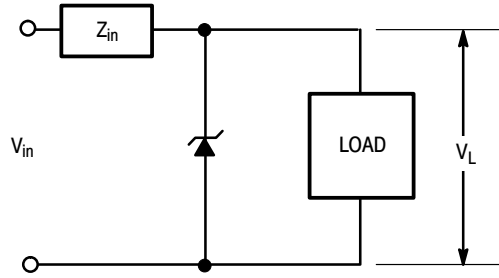

TYPICAL CHARACTERISTICS

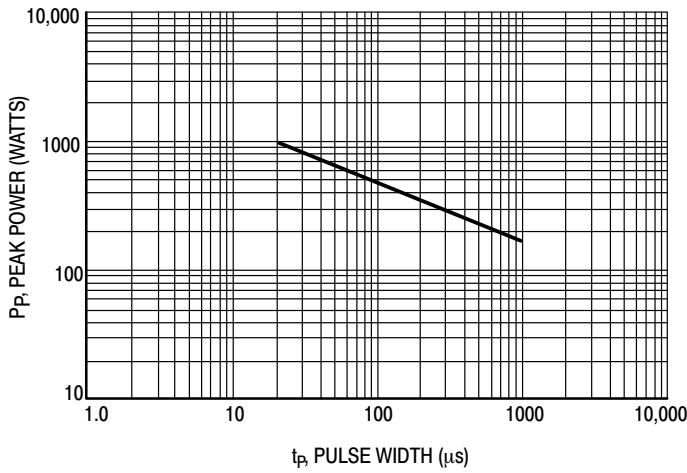

Figure 1. Pulse Rating Curve

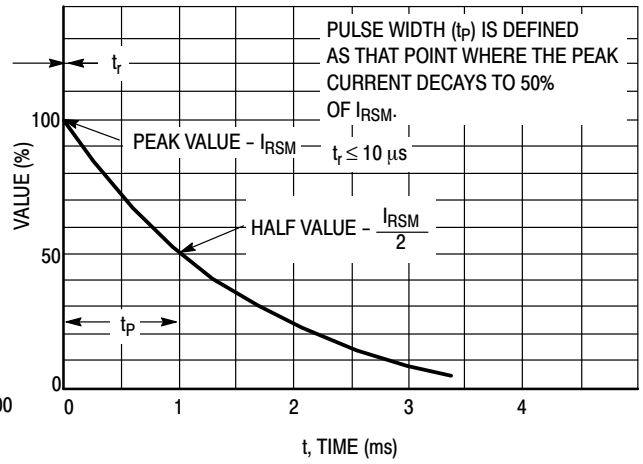

Figure 2. 10 X 1000 μ s Pulse Waveform

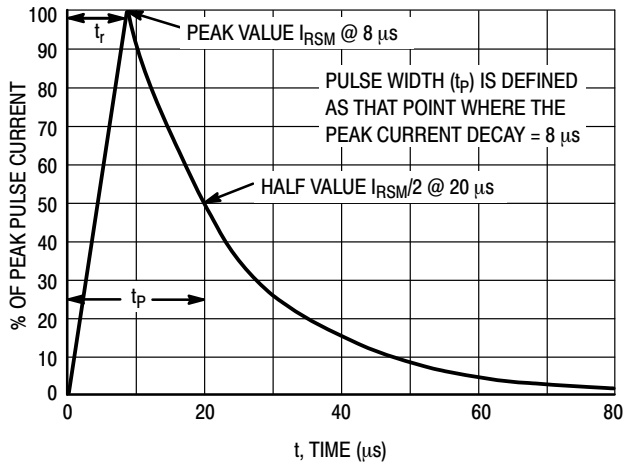

Figure 3. 8 X 20 μ s Pulse Waveform

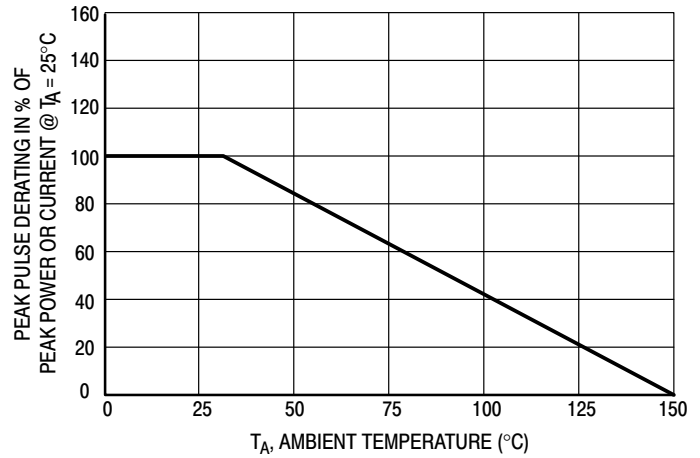

Figure 4. Pulse Derating Curve

1PMT5.0AT1G/T3G Series

TYPICAL CHARACTERISTICS

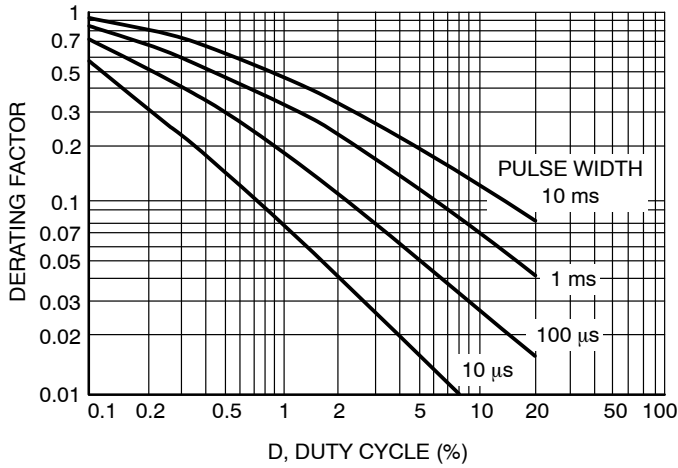

Figure 5. Typical Derating Factor for Duty Cycle

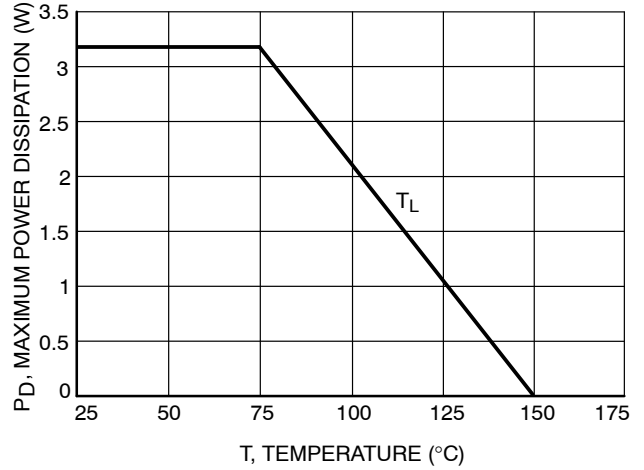

Figure 6. Steady State Power Derating

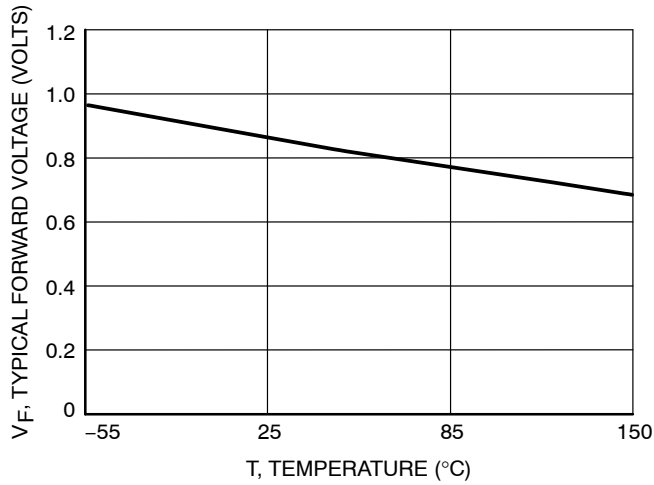

Figure 7. Forward Voltage

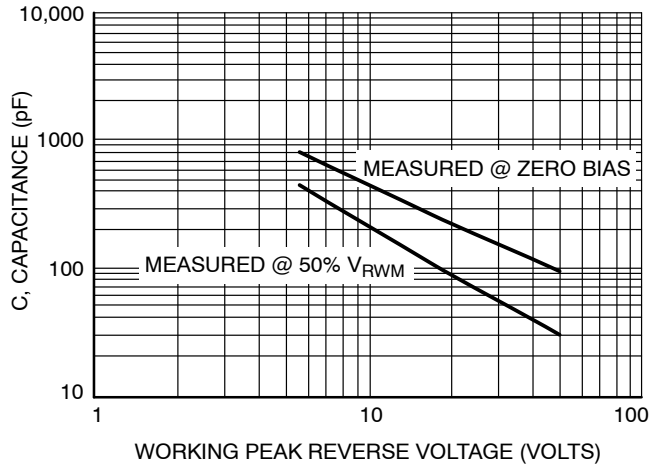
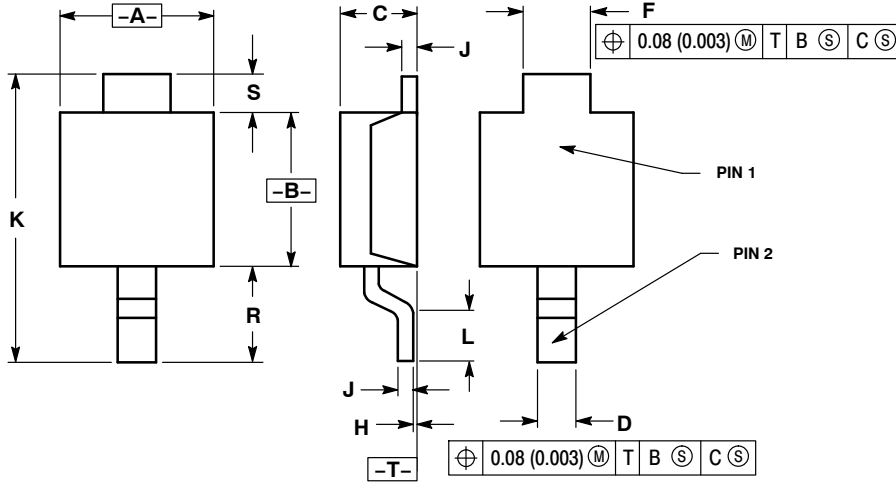

Figure 8. Capacitance versus Working Peak Reverse Voltage

1PMT5.0AT1G/T3G Series

PACKAGE DIMENSIONS

POWERMITE
CASE 457-04
ISSUE F



NOTES:

1. DIMENSIONING AND TOLERANCING PER ANSI Y14.5M, 1982.
2. CONTROLLING DIMENSION: MILLIMETER.
3. DIMENSIONS A AND B DO NOT INCLUDE MOLD FLASH, PROTRUSIONS OR GATE BURRS. MOLD FLASH, PROTRUSIONS OR GATE BURRS SHALL NOT EXCEED 0.15 (0.006) PER SIDE.

DIM	MILLIMETERS		INCHES	
	MIN	MAX	MIN	MAX
A	1.75	2.05	0.069	0.081
B	1.75	2.18	0.069	0.086
C	0.85	1.15	0.033	0.045
D	0.40	0.69	0.016	0.027
F	0.70	1.00	0.028	0.039
H	-0.05	+0.10	-0.002	+0.004
J	0.10	0.25	0.004	0.010
K	3.60	3.90	0.142	0.154
L	0.50	0.80	0.020	0.031
R	1.20	1.50	0.047	0.059
S	0.50	REF	0.019	REF

SOLDERING FOOTPRINT*

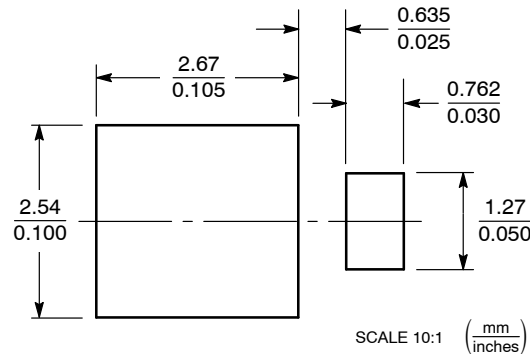

*For additional information on our Pb-Free strategy and soldering details, please download the ON Semiconductor Soldering and Mounting Techniques Reference Manual, SOLDERRM/D.

POWERMITE is a registered trademark of and used under a license from Microsemi Corporation.

ON Semiconductor and are registered trademarks of Semiconductor Components Industries, LLC (SCILLC). SCILLC owns the rights to a number of patents, trademarks, copyrights, trade secrets, and other intellectual property. A listing of SCILLC's product/patent coverage may be accessed at www.onsemi.com/site/pdf/Patent-Marking.pdf. SCILLC reserves the right to make changes without further notice to any products herein. SCILLC makes no warranty, representation or guarantee regarding the suitability of its products for any particular purpose, nor does SCILLC assume any liability arising out of the application or use of any product or circuit, and specifically disclaims any and all liability, including without limitation special, consequential or incidental damages. "Typical" parameters which may be provided in SCILLC data sheets and/or specifications can and do vary in different applications and actual performance may vary over time. All operating parameters, including "Typicals" must be validated for each customer application by customer's technical experts. SCILLC does not convey any license under its patent rights nor the rights of others. SCILLC products are not designed, intended, or authorized for use as components in systems intended for surgical implant into the body, or other applications intended to support or sustain life, or for any other application in which the failure of the SCILLC product could create a situation where personal injury or death may occur. Should Buyer purchase or use SCILLC products for any such unintended or unauthorized application, Buyer shall indemnify and hold SCILLC and its officers, employees, subsidiaries, affiliates, and distributors harmless against all claims, costs, damages, and expenses, and reasonable attorney fees arising out of, directly or indirectly, any claim of personal injury or death associated with such unintended or unauthorized use, even if such claim alleges that SCILLC was negligent regarding the design or manufacture of the part. SCILLC is an Equal Opportunity/Affirmative Action Employer. This literature is subject to all applicable copyright laws and is not for resale in any manner.

PUBLICATION ORDERING INFORMATION

LITERATURE FULFILLMENT:
Literature Distribution Center for ON Semiconductor
P.O. Box 5163, Denver, Colorado 80217 USA
Phone: 303-675-2175 or 800-344-3860 Toll Free USA/Canada
Fax: 303-675-2176 or 800-344-3867 Toll Free USA/Canada
Email: orderlit@onsemi.com

N. American Technical Support: 800-282-9855 Toll Free
USA/Canada
Europe, Middle East and Africa Technical Support:
Phone: 421 33 790 2910
Japan Customer Focus Center
Phone: 81-3-5817-1050

ON Semiconductor Website: www.onsemi.com
Order Literature: <http://www.onsemi.com/orderlit>

For additional information, please contact your local Sales Representative

Looking for pricing, stock, or lifecycle information?

Click below to explore more details on WIN SOURCE:

 [View 1PMT5.0AT1](#) on WIN SOURCE

 [ON Semiconductor](#) Information

Optimize Your Supply Chain with WIN SOURCE Solutions

-  Global Sourcing Solution
-  Obsolete Management
-  Cost Control Management
-  Shortage Management
-  Alternative Solution
-  Excess Inventory Management