



SPECIFICATION

SPEC. No. _____

DATE : _____

Customer

CUSTOMER'S PRODUCT NAME

TDK PRODUCT NAME

MULTILAYER CERAMIC CHIP CAPACITORS
C0603, C1005, C1608, C2012, C3216, C3225, C4532,
C5750 Type / 4V to 50V
C0G, X5R, X7R, Y5V Characteristics

Please sign and return this specification to your local TDK representatives. If orders are placed without this returned documentation, we must consider you found the specification acceptable.

THIS SPECIFICATION IS RECEIVED

DATE: _____ YEAR _____ MONTH _____ DAY _____

TDK-EPC Corporation
1-13-1, Nihonbashi, Chuo-ku, Tokyo
103-0027, Japan

ENGINEERING

ISSUED	CHECKED	APPROVED
DATE	DATE	DATE

Sales Office _____

Sales Tel. _____ () _____

PRODUCT CLASSIFICATION
CODE

040320

1. SCOPE

This specification is applicable to chip type multilayer ceramic capacitors with a priority over other relevant specifications. Production places defined in this specification shall be TDK-EPC Corporation Japan, TDK (Suzhou) Co., Ltd, TDK-EPC HONG KONG LIMITED, TDK (Malaysia) Sdn. Bhd, and TDK Components U.S.A. Inc.

EXPLANATORY NOTE:

This specification warrants the quality of the TDK ceramic chip capacitor. The product should be evaluated and confirmed in your product before use. If the use of the product exceeds the bounds of this specification, we can not guarantee its quality and/ or reliability.

2. CODE CONSTRUCTION

(Example) C2012 X7R 1E 105 K T
 (1) (2) (3) (4) (5) (6)

1. Type

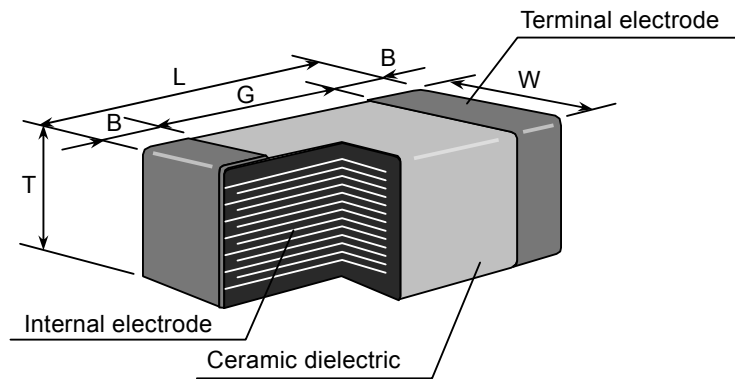

Please refer to product list for the dimension of each product. See Section 9 for inside structure and material.

2. Temperature Characteristics (Details are shown in table 1 No.7 and No.8 at page 6)

3. Rated Voltage

Symbol	Rated Voltage
1 H	50 V DC
1 E	25 V DC
1 C	16 V DC
1 A	10 V DC
0 J	6.3 V DC
0 G	4 V DC

4. Rated Capacitance

Stated in three digits and in units of pico farads (pF). The first and second digits identify the first and second significant figures of the capacitance; the third digit identifies the multiplier.

R is designated for a decimal point.

Example 2R2 → 2.2pF

105 → 1,000,000pF

5. Capacitance tolerance

Symbol	Tolerance	Capacitance
C	± 0.25 pF	10pF and under
D	± 0.5 pF	
J	± 5 %	Over 10pF
K	± 10 %	
M	± 20 %	
Z	+80, -20 %	

6. Packaging

Symbol	Packaging
B	Bulk
T	Taping

3. RATED CAPACITANCE AND CAPACITANCE TOLERANCE

3.1 Standard combination of rated capacitance and tolerances

Class	Temperature Characteristics	Capacitance tolerance		Rated capacitance
1	C0G	10pF and under	C ($\pm 0.25\text{pF}$)	0.5, 1, 1.5, 2, 2.2, 3, 3.3, 4, 4.7, 5
			D ($\pm 0.5\text{pF}$)	6, 6.8, 7, 8, 9, 10
		12pF to 10,000pF Over 10,000pF	J ($\pm 5\%$)	E – 12 series
			K ($\pm 10\%$)	E – 6 series
2	X5R X7R	10uF and under	K ($\pm 10\%$) M ($\pm 20\%$)	E – 6 series
		Over 10uF	M ($\pm 20\%$)	
	Y5V	0.1uF and under	Z (+80, -20%)	E – 1 series
		Over 0.1uF		E – 3 series

3.2 Capacitance Step in E series

E series	Capacitance Step												
E- 1	1.0												
E- 3	1.0			2.2			4.7						
E- 6	1.0		1.5		2.2		3.3		4.7		6.8		
E-12	1.0	1.2	1.5	1.8	2.2	2.7	3.3	3.9	4.7	5.6	6.8	8.2	

4. OPERATING TEMPERATURE RANGE

T.C.	Min. operating Temperature	Max. operating Temperature	Reference Temperature
X5R	-55°C	85°C	25°C
Y5V	-30°C	85°C	25°C
X7R C0G	-55°C	125°C	25°C

5. STORING CONDITION AND TERM

5 to 40°C at 20 to 70%RH

6 months Max.

6. P.C. BOARD

When mounting on an aluminum substrate, large case sizes such as C3225, C4532 and C5750 types are more likely to be affected by heat stress from the substrate. Please inquire separate specification for the large case sizes when mounted on the substrate.

7. INDUSTRIAL WASTE DISPOSAL

Dispose this product as industrial waste in accordance with local Industrial Waste Laws.

8. PERFORMANCE

No.	Item	Performance	Test or inspection method																	
1	External Appearance	No defects which may affect performance.	Inspect with magnifying glass (3×), in case of C0603 type, with magnifying glass (10×)																	
2	Insulation Resistance	10,000MΩ or 500MΩ·μF min. (As for the capacitors of rated voltage 16, 10 and 6.3V DC, 10,000 MΩ or 100MΩ·μF min.,) whichever smaller.	Apply rated voltage for 60s. As for the rated voltage 630V DC, apply 500V DC.																	
3	Voltage Proof	Withstand test voltage without insulation breakdown or other damage.	<table border="1"> <thead> <tr> <th>Class</th> <th>Apply voltage</th> </tr> </thead> <tbody> <tr> <td>Class 1</td> <td>3 × rated voltage</td> </tr> <tr> <td>Class 2</td> <td>2.5 × rated voltage</td> </tr> </tbody> </table> <p>Above DC voltage shall be applied for 1 to 5s. Charge / discharge current shall not exceed 50mA.</p>	Class	Apply voltage	Class 1	3 × rated voltage	Class 2	2.5 × rated voltage											
Class	Apply voltage																			
Class 1	3 × rated voltage																			
Class 2	2.5 × rated voltage																			
4	Capacitance	Within the specified capacitance tolerance.	<table border="1"> <thead> <tr> <th>Class</th> <th>Rated Capacitance</th> <th>Measuring frequency</th> <th>Measuring voltage</th> </tr> </thead> <tbody> <tr> <td rowspan="2">Class 1</td> <td>1000pF and under</td> <td>1MHz±10%</td> <td rowspan="2">0.5-5Vrms.</td> </tr> <tr> <td>Over 1000pF</td> <td>1kHz±10%</td> </tr> <tr> <td rowspan="2">Class 2</td> <td>10uF and under</td> <td>1kHz±10%</td> <td>0.5±0.2Vrms.</td> </tr> <tr> <td>Over 10uF</td> <td>120Hz±20%</td> <td>1.0±0.2Vrms.</td> </tr> </tbody> </table>	Class	Rated Capacitance	Measuring frequency	Measuring voltage	Class 1	1000pF and under	1MHz±10%	0.5-5Vrms.	Over 1000pF	1kHz±10%	Class 2	10uF and under	1kHz±10%	0.5±0.2Vrms.	Over 10uF	120Hz±20%	1.0±0.2Vrms.
Class	Rated Capacitance	Measuring frequency	Measuring voltage																	
Class 1	1000pF and under	1MHz±10%	0.5-5Vrms.																	
	Over 1000pF	1kHz±10%																		
Class 2	10uF and under	1kHz±10%	0.5±0.2Vrms.																	
	Over 10uF	120Hz±20%	1.0±0.2Vrms.																	
5	Q (Class 1)	<table border="1"> <thead> <tr> <th>Rated Capacitance</th> <th>Q</th> </tr> </thead> <tbody> <tr> <td>30pF and over</td> <td>1,000 min.</td> </tr> <tr> <td>Under 30pF</td> <td>400+20×C min.</td> </tr> </tbody> </table> <p>C : Rated capacitance (pF)</p>	Rated Capacitance	Q	30pF and over	1,000 min.	Under 30pF	400+20×C min.	See No.4 in this table for measuring condition.											
Rated Capacitance	Q																			
30pF and over	1,000 min.																			
Under 30pF	400+20×C min.																			
6	Dissipation Factor (Class 2)	<table border="1"> <thead> <tr> <th>T.C.</th> <th>Rated voltage</th> <th>D.F.</th> </tr> </thead> <tbody> <tr> <td rowspan="2">X5R X7R</td> <td rowspan="2">—</td> <td>0.03 max. 0.05 max. 0.075 max. 0.1 max. 0.125 max. 0.15 max.</td> </tr> <tr> <td>50V DC</td> <td>0.05 max.</td> </tr> <tr> <td rowspan="4">Y5V</td> <td>25V DC</td> <td>0.075 max.</td> </tr> <tr> <td>16V DC</td> <td>0.10 max.</td> </tr> <tr> <td>10V DC</td> <td>0.125 max.</td> </tr> <tr> <td>6.3V DC</td> <td>0.20 max.</td> </tr> </tbody> </table>	T.C.	Rated voltage	D.F.	X5R X7R	—	0.03 max. 0.05 max. 0.075 max. 0.1 max. 0.125 max. 0.15 max.	50V DC	0.05 max.	Y5V	25V DC	0.075 max.	16V DC	0.10 max.	10V DC	0.125 max.	6.3V DC	0.20 max.	See No.4 in this table for measuring condition.
T.C.	Rated voltage	D.F.																		
X5R X7R	—	0.03 max. 0.05 max. 0.075 max. 0.1 max. 0.125 max. 0.15 max.																		
		50V DC	0.05 max.																	
Y5V	25V DC	0.075 max.																		
	16V DC	0.10 max.																		
	10V DC	0.125 max.																		
	6.3V DC	0.20 max.																		

(8. Performance, continued)

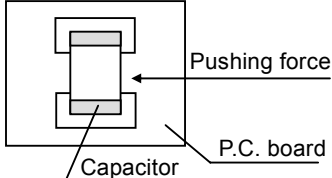
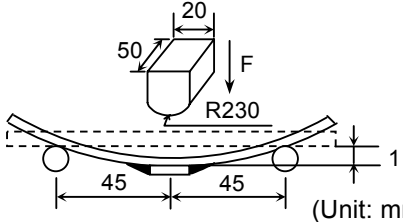
No.	Item	Performance	Test or inspection method										
7	Temperature Characteristics of Capacitance (Class 1)	<table border="1" style="width: 100%; border-collapse: collapse;"> <tr> <td style="width: 15%; text-align: center;">T.C.</td> <td style="text-align: center;">Temperature Coefficient (ppm/°C)</td> </tr> <tr> <td style="text-align: center;">C0G</td> <td style="text-align: center;">0 ± 30</td> </tr> </table> <p>Capacitance drift Within ± 0.2% or ±0.05pF, whichever larger.</p>	T.C.	Temperature Coefficient (ppm/°C)	C0G	0 ± 30	<p>Temperature coefficient shall be calculated based on values at 25°C and 85°C temperature.</p> <p>Measuring temperature below 20°C shall be -10°C and -25°C.</p>						
T.C.	Temperature Coefficient (ppm/°C)												
C0G	0 ± 30												
8	Temperature Characteristics of Capacitance (Class 2)	<p style="text-align: center;">Capacitance Change (%)</p> <hr/> <p style="text-align: center;">No voltage applied</p> <hr/> <p style="text-align: center;">X5R : ±15%</p> <p style="text-align: center;">X7R : ±15%</p> <p style="text-align: center;">Y5V : +22%, -82%</p> <hr/>	<p>Capacitance shall be measured by the steps shown in the following table after thermal equilibrium is obtained for each step.</p> <p>ΔC be calculated ref. STEP 3 reading</p> <table border="1" style="width: 100%; border-collapse: collapse;"> <thead> <tr> <th style="width: 15%;">Step</th> <th style="text-align: center;">Temperature(°C)</th> </tr> </thead> <tbody> <tr> <td style="text-align: center;">1</td> <td style="text-align: center;">Reference temp. ± 2</td> </tr> <tr> <td style="text-align: center;">2</td> <td style="text-align: center;">Min. operating temp. ± 2</td> </tr> <tr> <td style="text-align: center;">3</td> <td style="text-align: center;">Reference temp. ± 2</td> </tr> <tr> <td style="text-align: center;">4</td> <td style="text-align: center;">Max. operating temp. ± 2</td> </tr> </tbody> </table> <p>Measuring voltage: 0.1, 0.2, 0.5, 1.0Vrms.</p>	Step	Temperature(°C)	1	Reference temp. ± 2	2	Min. operating temp. ± 2	3	Reference temp. ± 2	4	Max. operating temp. ± 2
Step	Temperature(°C)												
1	Reference temp. ± 2												
2	Min. operating temp. ± 2												
3	Reference temp. ± 2												
4	Max. operating temp. ± 2												
9	Robustness of Terminations	No sign of termination coming off, breakage of ceramic, or other abnormal signs.	<p>Reflow solder the capacitor on P.C. board (shown in Appendix 1a or Appendix 1b) and apply a pushing force of 2N (C0603, C1005) or 5N (C1608, C2012, C3216, C3225, C4532, C5750) for 10±1s.</p> 										
10	Bending	No mechanical damage.	<p>Reflow solder the capacitor on P.C. board (shown in Appendix 2a or Appendix 2b) and bend it for 1mm.</p>  <p style="text-align: right;">(Unit: mm)</p>										

(8. Performance, continued)

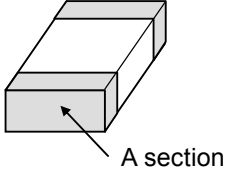
No.	Item	Performance	Test or inspection method																																							
11	Solderability	<p>New solder to cover over 75% of termination. 25% may have pinholes or rough spots but not concentrated in one spot. Ceramic surface of A sections shall not be exposed due to melting or shifting of termination material.</p> 	<p>Completely soak both terminations in solder at 235±5°C for 2±0.5s.</p> <p>Solder: H63A (JIS Z 3282)</p> <p>Flux: Isopropyl alcohol (JIS K 8839) Rosin(JIS K 5902) 25% solid solution.</p>																																							
12	Resistance to solder heat	<table border="1" style="width: 100%; border-collapse: collapse;"> <tr> <td colspan="2" data-bbox="391 741 553 842">External appearance</td> <td colspan="2" data-bbox="553 741 984 842">No cracks are allowed and terminations shall be covered at least 60% with new solder.</td> </tr> <tr> <td colspan="2" data-bbox="391 842 553 1178" rowspan="3">Capacitance</td> <td colspan="2" data-bbox="553 842 984 947"> <table border="1" style="width: 100%; border-collapse: collapse;"> <tr> <th colspan="2" data-bbox="553 842 756 947">Characteristics</th> <th data-bbox="756 842 984 947">Change from the value before test</th> </tr> <tr> <td data-bbox="553 947 667 1052">Class 1</td> <td data-bbox="667 947 756 1052">C0G</td> <td data-bbox="756 947 984 1052">Capacitance drift within ±2.5% or ±0.25pF, whichever larger.</td> </tr> <tr> <td data-bbox="553 1052 667 1178">Class 2</td> <td data-bbox="667 1052 756 1178">X5R X7R Y5V</td> <td data-bbox="756 1052 984 1178">± 7.5 % ± 7.5 % ± 20 %</td> </tr> </table> </td> </tr> <tr> <td colspan="2" data-bbox="391 1178 553 1377" rowspan="2">Q (Class 1)</td> <td colspan="2" data-bbox="553 1178 984 1377"> <table border="1" style="width: 100%; border-collapse: collapse;"> <tr> <th data-bbox="553 1178 773 1262">Rated Capacitance</th> <th data-bbox="773 1178 984 1262">Q</th> </tr> <tr> <td data-bbox="553 1262 773 1325">30pF and over</td> <td data-bbox="773 1262 984 1325">1,000 min.</td> </tr> <tr> <td data-bbox="553 1325 773 1377">Under 30pF</td> <td data-bbox="773 1325 984 1377">400+20×C min.</td> </tr> </table> <p style="text-align: center; font-size: small;">C : Rated capacitance (pF)</p> </td> </tr> <tr> <td colspan="2" data-bbox="391 1377 553 1461">D.F. (Class 2)</td> <td colspan="2" data-bbox="553 1377 984 1461">Meet the initial spec.</td> </tr> <tr> <td colspan="2" data-bbox="391 1461 553 1545">Insulation Resistance</td> <td colspan="2" data-bbox="553 1461 984 1545">Meet the initial spec.</td> </tr> <tr> <td colspan="2" data-bbox="391 1545 553 1619">Voltage proof</td> <td colspan="2" data-bbox="553 1545 984 1619">No insulation breakdown or other damage.</td> </tr> </table>	External appearance		No cracks are allowed and terminations shall be covered at least 60% with new solder.		Capacitance		<table border="1" style="width: 100%; border-collapse: collapse;"> <tr> <th colspan="2" data-bbox="553 842 756 947">Characteristics</th> <th data-bbox="756 842 984 947">Change from the value before test</th> </tr> <tr> <td data-bbox="553 947 667 1052">Class 1</td> <td data-bbox="667 947 756 1052">C0G</td> <td data-bbox="756 947 984 1052">Capacitance drift within ±2.5% or ±0.25pF, whichever larger.</td> </tr> <tr> <td data-bbox="553 1052 667 1178">Class 2</td> <td data-bbox="667 1052 756 1178">X5R X7R Y5V</td> <td data-bbox="756 1052 984 1178">± 7.5 % ± 7.5 % ± 20 %</td> </tr> </table>		Characteristics		Change from the value before test	Class 1	C0G	Capacitance drift within ±2.5% or ±0.25pF, whichever larger.	Class 2	X5R X7R Y5V	± 7.5 % ± 7.5 % ± 20 %	Q (Class 1)		<table border="1" style="width: 100%; border-collapse: collapse;"> <tr> <th data-bbox="553 1178 773 1262">Rated Capacitance</th> <th data-bbox="773 1178 984 1262">Q</th> </tr> <tr> <td data-bbox="553 1262 773 1325">30pF and over</td> <td data-bbox="773 1262 984 1325">1,000 min.</td> </tr> <tr> <td data-bbox="553 1325 773 1377">Under 30pF</td> <td data-bbox="773 1325 984 1377">400+20×C min.</td> </tr> </table> <p style="text-align: center; font-size: small;">C : Rated capacitance (pF)</p>		Rated Capacitance	Q	30pF and over	1,000 min.	Under 30pF	400+20×C min.	D.F. (Class 2)		Meet the initial spec.		Insulation Resistance		Meet the initial spec.		Voltage proof		No insulation breakdown or other damage.		<p>Completely soak both terminations in solder at 260±5°C for 5±1s.</p> <p>Preheating condition Temp.: 150±10°C Time: 1 to 2min.</p> <p>Flux: Isopropyl alcohol (JIS K 8839) Rosin (JIS K 5902) 25% solid solution.</p> <p>Solder: H63A (JIS Z 3282)</p> <p>Leave the capacitor in ambient conditions for 6 to 24h (Class 1) or 24±2h (Class 2) before measurement.</p>
External appearance		No cracks are allowed and terminations shall be covered at least 60% with new solder.																																								
Capacitance		<table border="1" style="width: 100%; border-collapse: collapse;"> <tr> <th colspan="2" data-bbox="553 842 756 947">Characteristics</th> <th data-bbox="756 842 984 947">Change from the value before test</th> </tr> <tr> <td data-bbox="553 947 667 1052">Class 1</td> <td data-bbox="667 947 756 1052">C0G</td> <td data-bbox="756 947 984 1052">Capacitance drift within ±2.5% or ±0.25pF, whichever larger.</td> </tr> <tr> <td data-bbox="553 1052 667 1178">Class 2</td> <td data-bbox="667 1052 756 1178">X5R X7R Y5V</td> <td data-bbox="756 1052 984 1178">± 7.5 % ± 7.5 % ± 20 %</td> </tr> </table>		Characteristics		Change from the value before test			Class 1	C0G	Capacitance drift within ±2.5% or ±0.25pF, whichever larger.	Class 2	X5R X7R Y5V	± 7.5 % ± 7.5 % ± 20 %																												
		Characteristics		Change from the value before test																																						
		Class 1	C0G	Capacitance drift within ±2.5% or ±0.25pF, whichever larger.																																						
Class 2	X5R X7R Y5V	± 7.5 % ± 7.5 % ± 20 %																																								
Q (Class 1)		<table border="1" style="width: 100%; border-collapse: collapse;"> <tr> <th data-bbox="553 1178 773 1262">Rated Capacitance</th> <th data-bbox="773 1178 984 1262">Q</th> </tr> <tr> <td data-bbox="553 1262 773 1325">30pF and over</td> <td data-bbox="773 1262 984 1325">1,000 min.</td> </tr> <tr> <td data-bbox="553 1325 773 1377">Under 30pF</td> <td data-bbox="773 1325 984 1377">400+20×C min.</td> </tr> </table> <p style="text-align: center; font-size: small;">C : Rated capacitance (pF)</p>		Rated Capacitance	Q	30pF and over	1,000 min.	Under 30pF	400+20×C min.																																	
		Rated Capacitance	Q																																							
30pF and over	1,000 min.																																									
Under 30pF	400+20×C min.																																									
D.F. (Class 2)		Meet the initial spec.																																								
Insulation Resistance		Meet the initial spec.																																								
Voltage proof		No insulation breakdown or other damage.																																								

(8. Performance, continued)

No.	Item		Performance	Test or inspection method															
13	Vibration	External appearance	No mechanical damage.	Reflow solder the capacitor on P.C. board (shown in Appendix 1a or Appendix 1b) before testing. Vibrate the capacitor with amplitude of 1.5mm P-P changing the frequencies from 10Hz to 55Hz and back to 10Hz after 1min. Repeat this for 2h each in 3 perpendicular directions.															
		Capacitance	<table border="1"> <thead> <tr> <th colspan="2">Characteristics</th> <th>Change from the value before test</th> </tr> </thead> <tbody> <tr> <td>Class1</td> <td>C0G</td> <td>$\pm 2.5\%$ or $\pm 0.25\text{pF}$, whichever larger.</td> </tr> <tr> <td rowspan="3">Class2</td> <td>X5R</td> <td>$\pm 7.5\%$</td> </tr> <tr> <td>X7R</td> <td>$\pm 7.5\%$</td> </tr> <tr> <td>Y5V</td> <td>$\pm 20\%$</td> </tr> </tbody> </table>		Characteristics		Change from the value before test	Class1	C0G	$\pm 2.5\%$ or $\pm 0.25\text{pF}$, whichever larger.	Class2	X5R	$\pm 7.5\%$	X7R	$\pm 7.5\%$	Y5V	$\pm 20\%$		
			Characteristics		Change from the value before test														
		Class1	C0G		$\pm 2.5\%$ or $\pm 0.25\text{pF}$, whichever larger.														
Class2	X5R	$\pm 7.5\%$																	
	X7R	$\pm 7.5\%$																	
	Y5V	$\pm 20\%$																	
Q (Class 1)	<table border="1"> <thead> <tr> <th>Rated Capacitance</th> <th>Q</th> </tr> </thead> <tbody> <tr> <td>30pF and over</td> <td>1,000 min.</td> </tr> <tr> <td>Under 30pF</td> <td>$400+20\times C$ min.</td> </tr> </tbody> </table>	Rated Capacitance	Q	30pF and over	1,000 min.	Under 30pF	$400+20\times C$ min.												
	Rated Capacitance	Q																	
30pF and over	1,000 min.																		
Under 30pF	$400+20\times C$ min.																		
D.F. (Class 2)	Meet the initial spec.																		
14	Temperature cycle	External appearance	No mechanical damage.	Reflow solder the capacitor on P.C. board (shown in Appendix 1a or Appendix 1b) before testing. Expose the capacitor in the condition step1 through step 4 and repeat 5 times consecutively. Leave the capacitor in ambient conditions for 6 to 24h (Class 1) or 24 \pm 2h (Class 2) before measurement .															
		Capacitance	<table border="1"> <thead> <tr> <th colspan="2">Characteristics</th> <th>Change from the value before test</th> </tr> </thead> <tbody> <tr> <td>Class1</td> <td>C0G</td> <td>$\pm 2.5\%$ or $\pm 0.25\text{pF}$, whichever larger.</td> </tr> <tr> <td rowspan="3">Class2</td> <td>X5R</td> <td>$\pm 15\%$</td> </tr> <tr> <td>X7R</td> <td>$\pm 15\%$</td> </tr> <tr> <td>Y5V</td> <td>$\pm 20\%$</td> </tr> </tbody> </table>		Characteristics		Change from the value before test	Class1	C0G	$\pm 2.5\%$ or $\pm 0.25\text{pF}$, whichever larger.	Class2	X5R	$\pm 15\%$	X7R	$\pm 15\%$	Y5V	$\pm 20\%$		
			Characteristics		Change from the value before test														
		Class1	C0G		$\pm 2.5\%$ or $\pm 0.25\text{pF}$, whichever larger.														
		Class2	X5R		$\pm 15\%$														
			X7R		$\pm 15\%$														
Y5V	$\pm 20\%$																		
Q (Class 1)	<table border="1"> <thead> <tr> <th>Rated Capacitance</th> <th>Q</th> </tr> </thead> <tbody> <tr> <td>30pF and over</td> <td>1,000 min.</td> </tr> <tr> <td>Under 30pF</td> <td>$400+20\times C$ min.</td> </tr> </tbody> </table>	Rated Capacitance	Q	30pF and over	1,000 min.	Under 30pF	$400+20\times C$ min.												
	Rated Capacitance	Q																	
30pF and over	1,000 min.																		
Under 30pF	$400+20\times C$ min.																		
D.F. (Class 2)	Meet the initial spec.																		
Insulation Resistance	Meet the initial spec.																		
Voltage proof	No insulation breakdown or other damage.																		
				<table border="1"> <thead> <tr> <th>Step</th> <th>Temperature(°C)</th> <th>Time (min.)</th> </tr> </thead> <tbody> <tr> <td>1</td> <td>Min. operating temp. ± 3</td> <td>30 ± 3</td> </tr> <tr> <td>2</td> <td>Reference Temp.</td> <td>2 - 5</td> </tr> <tr> <td>3</td> <td>Max. operating temp. ± 2</td> <td>30 ± 2</td> </tr> <tr> <td>4</td> <td>Reference Temp.</td> <td>2 - 5</td> </tr> </tbody> </table>	Step	Temperature(°C)	Time (min.)	1	Min. operating temp. ± 3	30 ± 3	2	Reference Temp.	2 - 5	3	Max. operating temp. ± 2	30 ± 2	4	Reference Temp.	2 - 5
Step	Temperature(°C)	Time (min.)																	
1	Min. operating temp. ± 3	30 ± 3																	
2	Reference Temp.	2 - 5																	
3	Max. operating temp. ± 2	30 ± 2																	
4	Reference Temp.	2 - 5																	

(8. Performance, continued)

No.	Item	Performance	Test or inspection method													
15	Moisture Resistance (Steady State)	External appearance No mechanical damage.	Reflow solder the capacitor on P.C. board (shown in Appendix 1a or Appendix 1b) before testing. Leave at temperature 40±2°C, 90 to 95%RH for 500 +24,0h. Leave the capacitor in ambient conditions for 6 to 24h (Class 1) or 24±2h (Class 2) before measurement.													
	Capacitance	<table border="1" data-bbox="581 352 943 548"> <thead> <tr> <th colspan="2">Characteristics</th> <th>Change from the value before test</th> </tr> </thead> <tbody> <tr> <td>Class 1</td> <td>C0G</td> <td>±5% or ±0.5pF, whichever larger.</td> </tr> <tr> <td rowspan="3">Class 2</td> <td>X5R</td> <td>± 25 %</td> </tr> <tr> <td>X7R</td> <td>± 25 %</td> </tr> <tr> <td>Y5V</td> <td>± 30 %</td> </tr> </tbody> </table>		Characteristics		Change from the value before test	Class 1	C0G	±5% or ±0.5pF, whichever larger.	Class 2	X5R	± 25 %	X7R	± 25 %	Y5V	± 30 %
	Characteristics			Change from the value before test												
	Class 1	C0G		±5% or ±0.5pF, whichever larger.												
	Class 2	X5R		± 25 %												
X7R		± 25 %														
Y5V		± 30 %														
Q (Class1)	<table border="1" data-bbox="581 625 943 800"> <thead> <tr> <th>Rated Capacitance</th> <th>Q</th> </tr> </thead> <tbody> <tr> <td>30pF and over</td> <td>350 min.</td> </tr> <tr> <td>10pF and over under 30pF</td> <td>275+5/2×C min.</td> </tr> <tr> <td>Under 10pF</td> <td>200+10×C min.</td> </tr> </tbody> </table> <p style="text-align: center;">C : Rated capacitance (pF)</p>	Rated Capacitance	Q	30pF and over	350 min.	10pF and over under 30pF	275+5/2×C min.	Under 10pF	200+10×C min.							
Rated Capacitance	Q															
30pF and over	350 min.															
10pF and over under 30pF	275+5/2×C min.															
Under 10pF	200+10×C min.															
D.F. (Class2)	Characteristics X5R: 200% of initial spec. max. X7R: 200% of initial spec. max Y5V: 150% of initial spec. max															
Insulation Resistance	1,000MΩ or 50MΩ·μF min. (As for the capacitors of rated voltage 16, 10 and 6.3V DC, 1,000 MΩ or 10MΩ·μF min.,) whichever smaller.															

(8. Performance, continued)

No.	Item	Performance	Test or inspection method													
16	Moisture Resistance	No mechanical damage.	Reflow solder the capacitor on P.C. board (shown in Appendix 1a or Appendix 1b) before testing.													
	Capacitance	<table border="1" data-bbox="584 352 954 588"> <thead> <tr> <th colspan="2">Characteristics</th> <th>Change from the value before test</th> </tr> </thead> <tbody> <tr> <td>Class 1</td> <td>C0G</td> <td>±7.5% or ±0.75pF, whichever larger.</td> </tr> <tr> <td rowspan="3">Class 2</td> <td>X5R</td> <td>± 25 %</td> </tr> <tr> <td>X7R</td> <td>± 25 %</td> </tr> <tr> <td>Y5V</td> <td>± 30 % *(± 40 %)</td> </tr> </tbody> </table> <p data-bbox="558 598 954 625">* Inside () is applied to Y5V 6.3V product.</p>	Characteristics		Change from the value before test	Class 1	C0G	±7.5% or ±0.75pF, whichever larger.	Class 2	X5R	± 25 %	X7R	± 25 %	Y5V	± 30 % *(± 40 %)	<p data-bbox="980 394 1455 499">Apply the rated voltage at temperature 40±2°C and 90 to 95%RH for 500 +24,0h.</p> <p data-bbox="980 541 1455 604">Charge/discharge current shall not exceed 50mA.</p>
	Characteristics		Change from the value before test													
	Class 1	C0G	±7.5% or ±0.75pF, whichever larger.													
	Class 2	X5R	± 25 %													
X7R		± 25 %														
Y5V		± 30 % *(± 40 %)														
Q (Class 1)	<table border="1" data-bbox="584 667 954 787"> <thead> <tr> <th>Rated Capacitance</th> <th>Q</th> </tr> </thead> <tbody> <tr> <td>30pF and over</td> <td>200 min.</td> </tr> <tr> <td>Under 30pF</td> <td>100+10/3×C min.</td> </tr> </tbody> </table> <p data-bbox="714 808 954 835">C : Rated capacitance (pF)</p>	Rated Capacitance	Q	30pF and over	200 min.	Under 30pF	100+10/3×C min.	<p data-bbox="980 657 1455 762">Leave the capacitor in ambient conditions for 6 to 24h (Class 1) or 24±2h (Class 2) before measurement.</p>								
Rated Capacitance	Q															
30pF and over	200 min.															
Under 30pF	100+10/3×C min.															
D.F. (Class 2)	<p data-bbox="558 846 980 993">Characteristics X5R: 200% of initial spec. max. X7R: 200% of initial spec. max. Y5V: 150% of initial spec. max</p>	<p data-bbox="980 846 1455 951">Voltage treat the capacitor under testing temperature and voltage for 1 hour.</p> <p data-bbox="980 961 1455 993">Leave the capacitor in ambient</p>														
Insulation Resistance	<p data-bbox="558 1003 980 1211">500MΩ or 25MΩ·μF min. (As for the capacitors of rated voltage 16, 10 and 6.3V DC, 500 MΩ or 5MΩ·μF min.,) whichever smaller.</p>	<p data-bbox="980 1003 1455 1056">Voltage conditioning (only for Class 2)</p> <p data-bbox="980 1066 1455 1098">Use this measurement for initial value.</p>														

(8. Performance, continued)

No.	Item	Performance	Test or inspection method													
17	Life	No mechanical damage.	Reflow solder the capacitor on P.C. board (shown in Appendix 1a or Appendix 1b) before testing.													
	External appearance															
	Capacitance	<table border="1"> <thead> <tr> <th colspan="2">Characteristics</th> <th>Change from the value before test</th> </tr> </thead> <tbody> <tr> <td>Class 1</td> <td>C0G</td> <td>±3% or ±0.3pF, whichever larger.</td> </tr> <tr> <td rowspan="3">Class 2</td> <td>X5R</td> <td>± 25 %</td> </tr> <tr> <td>X7R</td> <td>± 25 %</td> </tr> <tr> <td>Y5V</td> <td>± 30 % *(± 40 %)</td> </tr> </tbody> </table> <p>* Inside () is applied to Y5V 6.3V product.</p>	Characteristics		Change from the value before test	Class 1	C0G	±3% or ±0.3pF, whichever larger.	Class 2	X5R	± 25 %	X7R	± 25 %	Y5V	± 30 % *(± 40 %)	<p>Below the voltage shall be applied at 125±2°C for 1,000 +48, 0h.</p> <hr/> <p>Applied voltage</p> <hr/> <p>Rated voltage x2</p> <hr/> <p>Rated voltage x1.5</p> <hr/> <p>Rated voltage x1.2</p> <hr/> <p>Rated voltage x1</p>
	Characteristics		Change from the value before test													
	Class 1	C0G	±3% or ±0.3pF, whichever larger.													
Class 2	X5R	± 25 %														
	X7R	± 25 %														
	Y5V	± 30 % *(± 40 %)														
Q (Class 1)	<table border="1"> <thead> <tr> <th>Rated Capacitance</th> <th>Q</th> </tr> </thead> <tbody> <tr> <td>30pF and over</td> <td>350 min.</td> </tr> <tr> <td>10pF and over under 30pF</td> <td>275+5/2×C min.</td> </tr> <tr> <td>Under 10pF</td> <td>200+10×C min.</td> </tr> </tbody> </table> <p>C : Rated capacitance (pF)</p>	Rated Capacitance	Q	30pF and over	350 min.	10pF and over under 30pF	275+5/2×C min.	Under 10pF	200+10×C min.	<p>Charge/discharge current shall not exceed 50mA.</p> <p>Leave the capacitor in ambient conditions for 6 to 24h (Class 1) or 24±2h (Class 2) before measurement.</p>						
Rated Capacitance	Q															
30pF and over	350 min.															
10pF and over under 30pF	275+5/2×C min.															
Under 10pF	200+10×C min.															
D.F. (Class 2)	<p>Characteristics</p> <p>X5R: 200% of initial spec. max.</p> <p>X7R: 200% of initial spec. max</p> <p>Y5V: 150% of initial spec. max</p>	<p>Voltage conditioning (only for class 2)</p> <p>Voltage treat the capacitor under testing temperature and voltage for 1 hour.</p> <p>Leave the capacitor in ambient conditions for 24±2h before measurement.</p> <p>Use this measurement for initial value.</p>														
Insulation Resistance	<p>1,000MΩ or 50MΩ·μF min.</p> <p>(As for the capacitors of rated voltage 16, 10 and 6.3V DC, 1,000 MΩ or 10MΩ·μF min.,) whichever smaller.</p>															

*As for the initial measurement of capacitors (Class2) on number 8,12,13,14 and 15, leave capacitor at 150 –10, 0°C for 1 hour and measure the value after leaving capacitor for 24±2h in ambient conditions.

9. INSIDE STRUCTURE AND MATERIAL

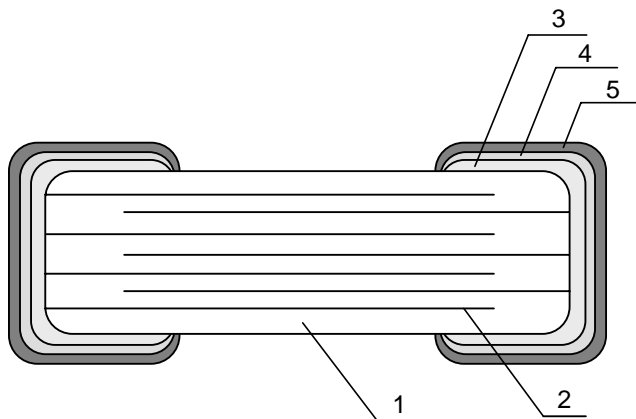

No.	NAME	MATERIAL	
		Class 1	Class 2
1	Dielectric	CaZrO ₃	BaTiO ₃
2	Electrode	Nickel (Ni)	
3	Termination	Copper (Cu)	
4		Nickel (Ni)	
5		Tin (Sn)	

10. RECOMMENDATION

As for C3225, C4532 and C5750 types, it is recommended to provide a slit (about 1mm wide) in the board under the components to improve washing flux. Please make sure to completely remove all cleaning solvents.

11. SOLDERING CONDITION

For C1608 (CC0603) ~ C3216 (CC1206) case size, TDK recommends reflow or wave soldering. Smaller case sizes, C0603 (CC0201) ~ C1005 (CC0402), and larger case sizes, C3225 (CC1210) ~ C5750 (CC2220), should use reflow solder only. See "Caution" Section No.3 for details.

12. Caution

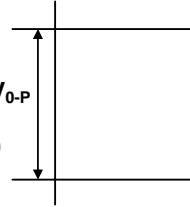
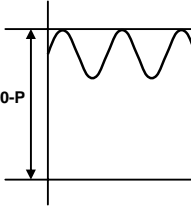
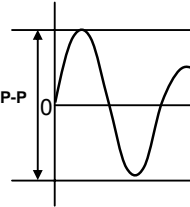
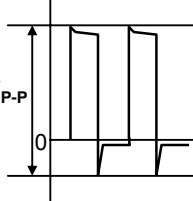
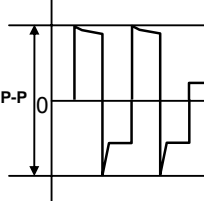
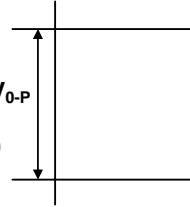
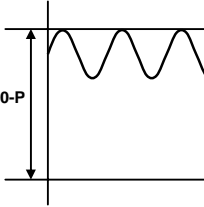
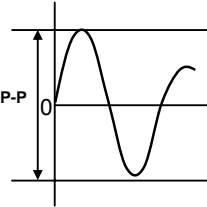
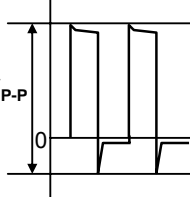
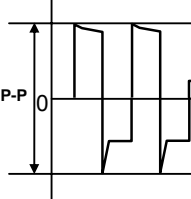
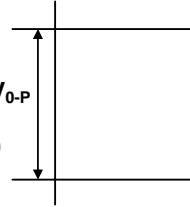
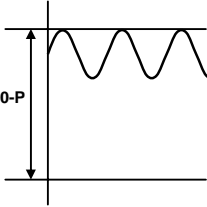
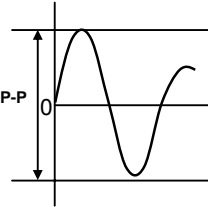
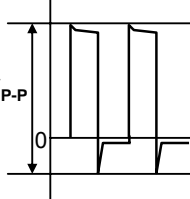
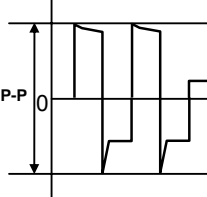
No.	Process	Condition														
1	Operating Condition (Storage, Transportation)	<p>1.1 Storage</p> <ol style="list-style-type: none"> The capacitor must be stored in an ambient temperature of 5 to 40°C with a relative humidity of 20 to 70%RH. The product should be used within 6 months upon receipt. The capacitor must be operated and stored in an environment free of condensation and corrosive gases such as hydrogen sulphide, hydrogen sulphate, chlorine, ammonia and sulfur. Avoid storing in sun light and falling of dew. Do not use capacitor under high humidity and high/low atmospheric pressure which may compromise product reliability. Capacitor should be tested for solderability when stored for long periods of time. <p>1.2 Handling in transportation</p> <p>In case of the transportation, the performance of the capacitor may be deteriorated depending on the transportation condition. (Refer to JEITA RCR-2335B 9.2 "Handling in transportation")</p>														
2	Circuit design	<p>2.1 Operating temperature</p> <p>Operating temperature should be followed strictly within this specification.</p> <ol style="list-style-type: none"> Do not use capacitors above the maximum allowable operating temperature. Surface temperature including self heating should be below maximum operating temperature. (Due to dielectric loss, capacitors will heat itself when AC is applied. Especially at high frequencies around its SRF, the heat might be so extreme that it may damage itself or the product it's mounted on. Please design the circuit so that the maximum temperature of the capacitors (including the self heating) will be below the maximum allowable operating temperature. Temperature rise at capacitor surface shall be below 20°C) The electrical characteristics of the capacitor will vary depending on the temperature. The capacitor should be selected and designed after taking temperature into consideration. <p>2.2 Operating voltage</p> <ol style="list-style-type: none"> Operating voltage across the terminals should be below the rated voltage. When AC and DC are super imposed, V_{0-P} must be below the rated voltage. Reference figures 1 and 2 below. AC or pulse with overshooting, V_{P-P} must be below the rated voltage. Reference figures 3, 4, and 5 below. When the voltage is started/stopped to the circuit an irregular voltage may be generated for a transit period because of resonance or switching. Be sure to use the capacitor within rated voltage during these Irregular voltage periods. <table border="1" data-bbox="506 1354 1414 1612"> <thead> <tr> <th data-bbox="506 1354 683 1396">Voltage</th> <th data-bbox="683 1354 927 1396">(1) DC voltage</th> <th data-bbox="927 1354 1170 1396">(2) DC+AC voltage</th> <th data-bbox="1170 1354 1414 1396">(3) AC voltage</th> </tr> </thead> <tbody> <tr> <td data-bbox="506 1396 683 1612">Positional Measurement (Rated voltage)</td> <td data-bbox="683 1396 927 1612">  </td> <td data-bbox="927 1396 1170 1612">  </td> <td data-bbox="1170 1396 1414 1612">  </td> </tr> </tbody> </table> <table border="1" data-bbox="506 1640 1170 1890"> <thead> <tr> <th data-bbox="506 1640 683 1682">Voltage</th> <th data-bbox="683 1640 927 1682">(4) Pulse voltage (A)</th> <th data-bbox="927 1640 1170 1682">(5) Pulse voltage (B)</th> </tr> </thead> <tbody> <tr> <td data-bbox="506 1682 683 1890">Positional Measurement (Rated voltage)</td> <td data-bbox="683 1682 927 1890">  </td> <td data-bbox="927 1682 1170 1890">  </td> </tr> </tbody> </table>	Voltage	(1) DC voltage	(2) DC+AC voltage	(3) AC voltage	Positional Measurement (Rated voltage)				Voltage	(4) Pulse voltage (A)	(5) Pulse voltage (B)	Positional Measurement (Rated voltage)		
Voltage	(1) DC voltage	(2) DC+AC voltage	(3) AC voltage													
Positional Measurement (Rated voltage)																
Voltage	(4) Pulse voltage (A)	(5) Pulse voltage (B)														
Positional Measurement (Rated voltage)																

(12. Caution, continued)

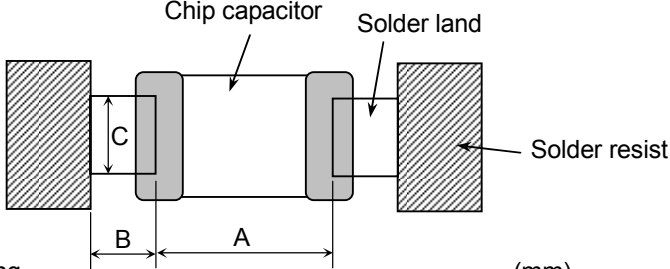
No.	Process	Condition																																																								
2	Circuit design	<p>2.2 Operation Voltage (continued)</p> <p>2. Even below the rated voltage, if repetitive high AC frequency or pulsed voltage is applied, the reliability of the capacitors may be reduced.</p> <p>3. The effective capacitance will vary depending on applied DC and AC voltages. The capacitor should be selected after considering the voltage affects.</p> <p>2.3 Frequency</p> <p>When Class 2 capacitors are used in AC and/or pulsed voltages, the capacitors may self vibrate and generate audible sound (piezoelectric affect).</p>																																																								
3	Designing P.C. Board	<p>The amount of solder at the terminations has a direct effect on the reliability of the capacitor.</p> <ol style="list-style-type: none"> 1. The greater the amount of solder, the higher the stress on the chip capacitor, and the more likely that it will break. When designing a P.C. board, determine the shape and size of the solder lands to have proper amount of solder on the terminations. 2. Avoid using common solder land for multiple terminations and provide individual solder land for each termination instead. 3. Size and recommended land dimensions provided below: <div style="text-align: center;">  <p>The diagram shows a top-down view of a chip capacitor mounted on a PCB. The capacitor is a small rectangular component with two leads. The solder lands on either side are shaded. Dimension 'A' is the length of the capacitor. Dimension 'B' is the length of the solder land on one side. Dimension 'C' is the width of the capacitor. Labels include 'Chip capacitor', 'Solder land', and 'Solder resist'.</p> </div> <p>Flow soldering (mm)</p> <table border="1" data-bbox="532 1087 1279 1297"> <thead> <tr> <th>Type</th> <th>C1608 [CC0603]</th> <th>C2012 [CC0805]</th> <th>C3216 [CC1206]</th> </tr> </thead> <tbody> <tr> <td>A</td> <td>0.7 - 1.0</td> <td>1.0 - 1.3</td> <td>2.1 - 2.5</td> </tr> <tr> <td>B</td> <td>0.8 - 1.0</td> <td>1.0 - 1.2</td> <td>1.1 - 1.3</td> </tr> <tr> <td>C</td> <td>0.6 - 0.8</td> <td>0.8 - 1.1</td> <td>1.0 - 1.3</td> </tr> </tbody> </table> <p>Reflow soldering (mm)</p> <table border="1" data-bbox="516 1360 1383 1570"> <thead> <tr> <th>Type</th> <th>C0603 [CC0201]</th> <th>C1005 [CC0402]</th> <th>C1608 [CC0603]</th> <th>C2012 [CC0805]</th> </tr> </thead> <tbody> <tr> <td>A</td> <td>0.25 - 0.35</td> <td>0.3 - 0.5</td> <td>0.6 - 0.8</td> <td>0.9 - 1.2</td> </tr> <tr> <td>B</td> <td>0.2 - 0.3</td> <td>0.35 - 0.45</td> <td>0.6 - 0.8</td> <td>0.7 - 0.9</td> </tr> <tr> <td>C</td> <td>0.25 - 0.35</td> <td>0.4 - 0.6</td> <td>0.6 - 0.8</td> <td>0.9 - 1.2</td> </tr> </tbody> </table> <table border="1" data-bbox="516 1602 1383 1812"> <thead> <tr> <th>Type</th> <th>C3216 [CC1206]</th> <th>C3225 [CC1210]</th> <th>C4532 [CC1812]</th> <th>C5750 [CC2220]</th> </tr> </thead> <tbody> <tr> <td>A</td> <td>2.0 - 2.4</td> <td>2.0 - 2.4</td> <td>3.1 - 3.7</td> <td>4.1 - 4.8</td> </tr> <tr> <td>B</td> <td>1.0 - 1.2</td> <td>1.0 - 1.2</td> <td>1.2 - 1.4</td> <td>1.2 - 1.4</td> </tr> <tr> <td>C</td> <td>1.1 - 1.6</td> <td>1.9 - 2.5</td> <td>2.4 - 3.2</td> <td>4.0 - 5.0</td> </tr> </tbody> </table>	Type	C1608 [CC0603]	C2012 [CC0805]	C3216 [CC1206]	A	0.7 - 1.0	1.0 - 1.3	2.1 - 2.5	B	0.8 - 1.0	1.0 - 1.2	1.1 - 1.3	C	0.6 - 0.8	0.8 - 1.1	1.0 - 1.3	Type	C0603 [CC0201]	C1005 [CC0402]	C1608 [CC0603]	C2012 [CC0805]	A	0.25 - 0.35	0.3 - 0.5	0.6 - 0.8	0.9 - 1.2	B	0.2 - 0.3	0.35 - 0.45	0.6 - 0.8	0.7 - 0.9	C	0.25 - 0.35	0.4 - 0.6	0.6 - 0.8	0.9 - 1.2	Type	C3216 [CC1206]	C3225 [CC1210]	C4532 [CC1812]	C5750 [CC2220]	A	2.0 - 2.4	2.0 - 2.4	3.1 - 3.7	4.1 - 4.8	B	1.0 - 1.2	1.0 - 1.2	1.2 - 1.4	1.2 - 1.4	C	1.1 - 1.6	1.9 - 2.5	2.4 - 3.2	4.0 - 5.0
Type	C1608 [CC0603]	C2012 [CC0805]	C3216 [CC1206]																																																							
A	0.7 - 1.0	1.0 - 1.3	2.1 - 2.5																																																							
B	0.8 - 1.0	1.0 - 1.2	1.1 - 1.3																																																							
C	0.6 - 0.8	0.8 - 1.1	1.0 - 1.3																																																							
Type	C0603 [CC0201]	C1005 [CC0402]	C1608 [CC0603]	C2012 [CC0805]																																																						
A	0.25 - 0.35	0.3 - 0.5	0.6 - 0.8	0.9 - 1.2																																																						
B	0.2 - 0.3	0.35 - 0.45	0.6 - 0.8	0.7 - 0.9																																																						
C	0.25 - 0.35	0.4 - 0.6	0.6 - 0.8	0.9 - 1.2																																																						
Type	C3216 [CC1206]	C3225 [CC1210]	C4532 [CC1812]	C5750 [CC2220]																																																						
A	2.0 - 2.4	2.0 - 2.4	3.1 - 3.7	4.1 - 4.8																																																						
B	1.0 - 1.2	1.0 - 1.2	1.2 - 1.4	1.2 - 1.4																																																						
C	1.1 - 1.6	1.9 - 2.5	2.4 - 3.2	4.0 - 5.0																																																						

(12. Caution, continued)

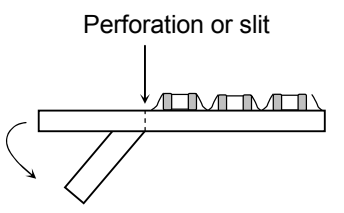
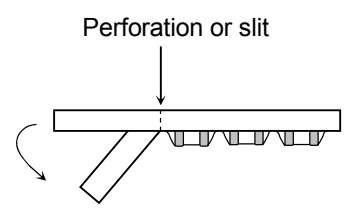
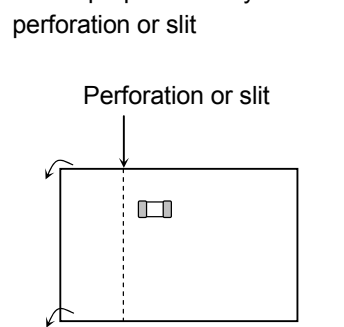
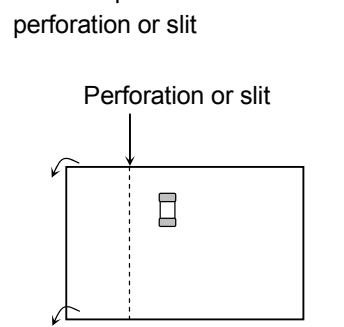
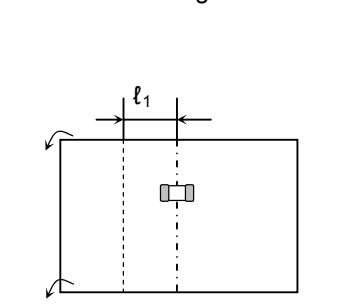
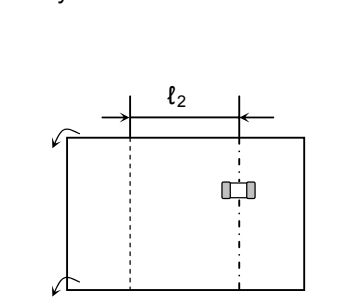
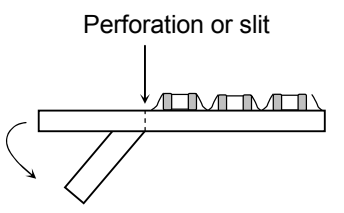
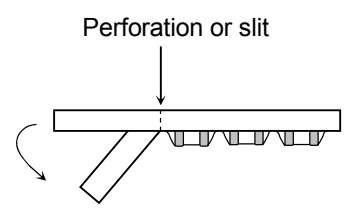
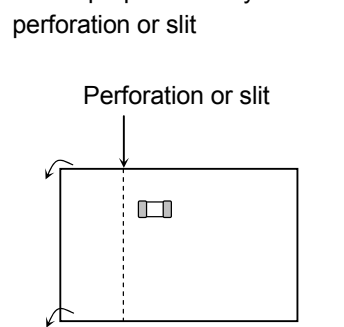
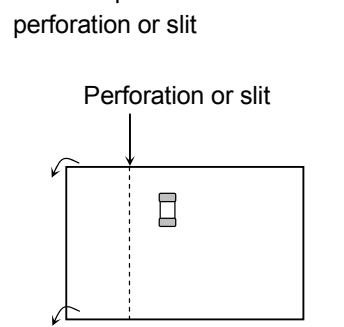
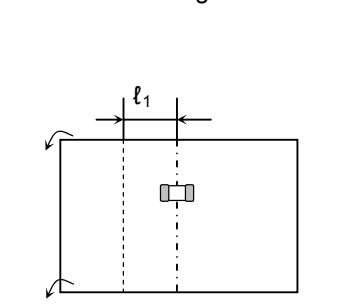
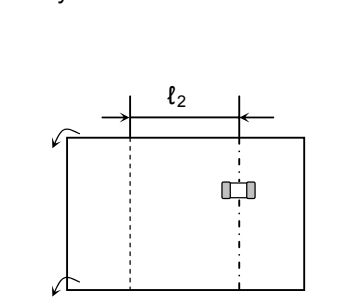
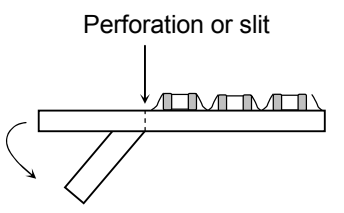
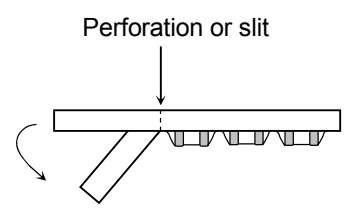
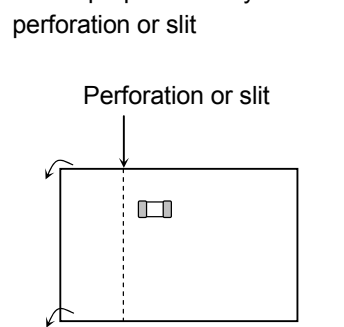
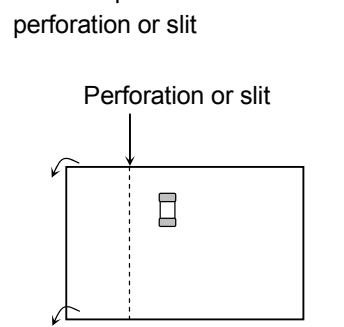
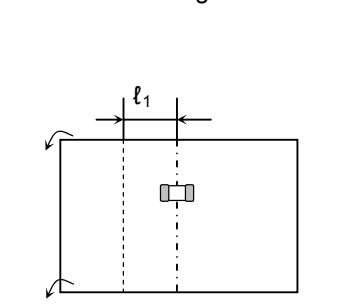
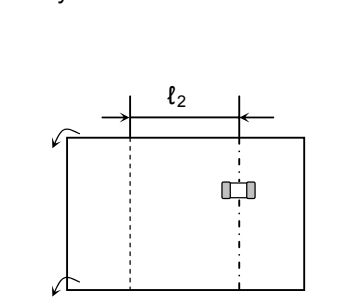
No.	Process	Condition												
3	Designing P.C. Board	<p>4. Recommended chip capacitor layout is provided below:</p> <table border="1"> <thead> <tr> <th data-bbox="506 235 683 310"></th> <th data-bbox="683 235 1040 310">Disadvantage against bending stress</th> <th data-bbox="1040 235 1398 310">Advantage against bending stress</th> </tr> </thead> <tbody> <tr> <td data-bbox="506 310 683 701">Mounting face</td> <td data-bbox="683 310 1040 701"> <p>Perforation or slit</p>  <p>Break P.C. board with mounted side up.</p> </td> <td data-bbox="1040 310 1398 701"> <p>Perforation or slit</p>  <p>Break P.C. board with mounted side down.</p> </td> </tr> <tr> <td data-bbox="506 701 683 1121">Chip arrangement (Direction)</td> <td data-bbox="683 701 1040 1121"> <p>Mount perpendicularly to perforation or slit</p>  </td> <td data-bbox="1040 701 1398 1121"> <p>Mount in parallel with perforation or slit</p>  </td> </tr> <tr> <td data-bbox="506 1121 683 1570">Distance from slit</td> <td data-bbox="683 1121 1040 1570"> <p>Closer to slit is higher stress</p>  <p>$(l_1 < l_2)$</p> </td> <td data-bbox="1040 1121 1398 1570"> <p>Away from slit is less stress</p>  <p>$(l_1 < l_2)$</p> </td> </tr> </tbody> </table>		Disadvantage against bending stress	Advantage against bending stress	Mounting face	<p>Perforation or slit</p>  <p>Break P.C. board with mounted side up.</p>	<p>Perforation or slit</p>  <p>Break P.C. board with mounted side down.</p>	Chip arrangement (Direction)	<p>Mount perpendicularly to perforation or slit</p> 	<p>Mount in parallel with perforation or slit</p> 	Distance from slit	<p>Closer to slit is higher stress</p>  <p>$(l_1 < l_2)$</p>	<p>Away from slit is less stress</p>  <p>$(l_1 < l_2)$</p>
	Disadvantage against bending stress	Advantage against bending stress												
Mounting face	<p>Perforation or slit</p>  <p>Break P.C. board with mounted side up.</p>	<p>Perforation or slit</p>  <p>Break P.C. board with mounted side down.</p>												
Chip arrangement (Direction)	<p>Mount perpendicularly to perforation or slit</p> 	<p>Mount in parallel with perforation or slit</p> 												
Distance from slit	<p>Closer to slit is higher stress</p>  <p>$(l_1 < l_2)$</p>	<p>Away from slit is less stress</p>  <p>$(l_1 < l_2)$</p>												

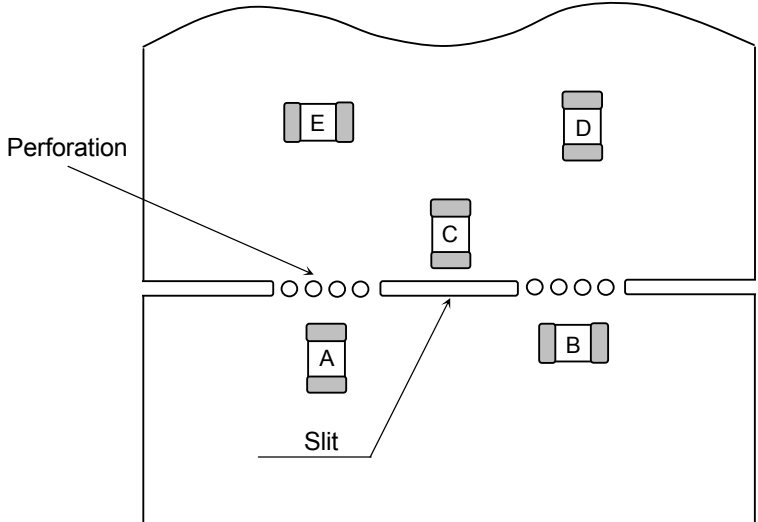
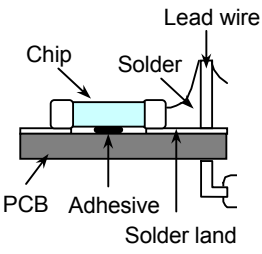
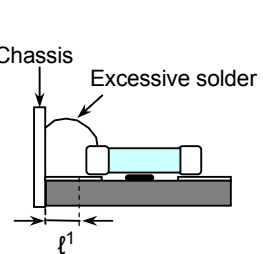
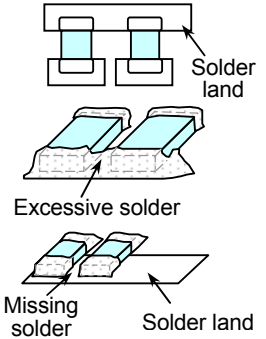
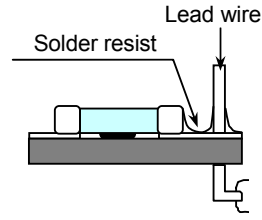
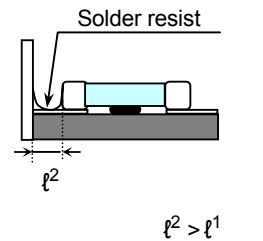
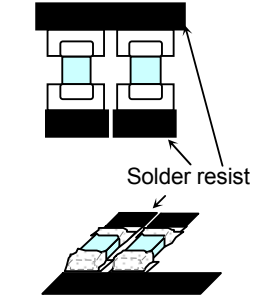
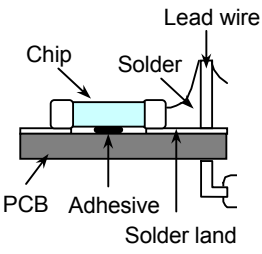
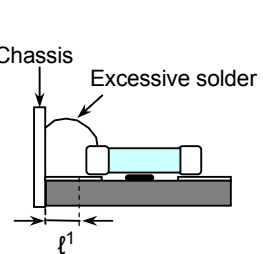
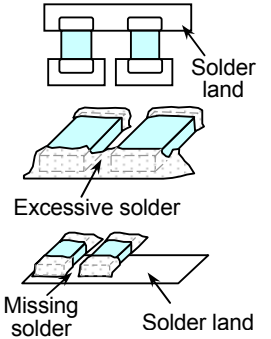
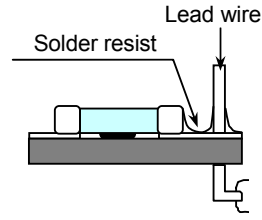
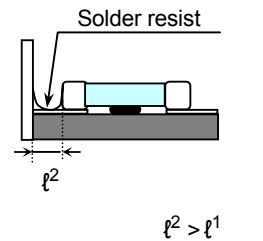
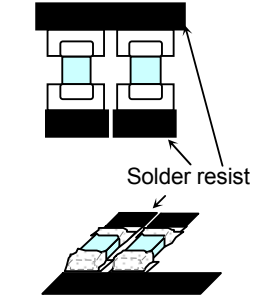
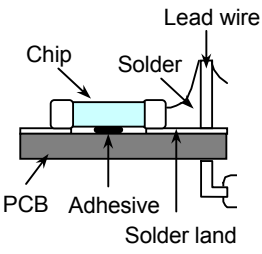
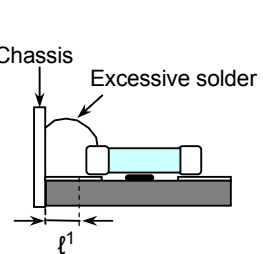
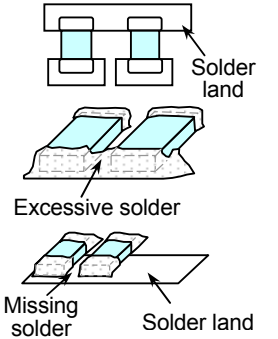
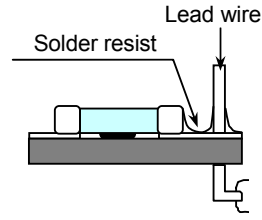
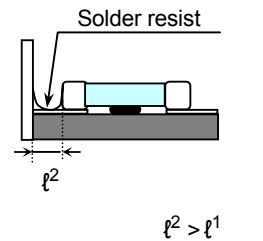
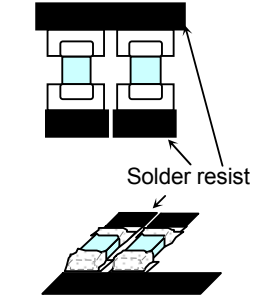
No.	Process	Condition												
3	Designing P.C. Board (continued)	<p>5. Mechanical stress varies according to location of chip capacitors on the P.C. board.</p>  <p>The relative stress applied to these capacitors during depaneling is in the following order: $A > B = C > D > E$</p> <p>6. Layout recommendation</p> <table border="1" data-bbox="418 947 1448 1801"> <thead> <tr> <th data-bbox="418 947 570 1052">Example</th> <th data-bbox="574 947 857 1052">Use of common solder land</th> <th data-bbox="862 947 1144 1052">Soldering with chassis</th> <th data-bbox="1149 947 1448 1052">Use of common solder land with other SMD</th> </tr> </thead> <tbody> <tr> <td data-bbox="418 1058 570 1409">Need to avoid</td> <td data-bbox="574 1058 857 1409">  </td> <td data-bbox="862 1058 1144 1409">  </td> <td data-bbox="1149 1058 1448 1409">  </td> </tr> <tr> <td data-bbox="418 1415 570 1801">Recommendation</td> <td data-bbox="574 1415 857 1801">  </td> <td data-bbox="862 1415 1144 1801">  </td> <td data-bbox="1149 1415 1448 1801">  </td> </tr> </tbody> </table>	Example	Use of common solder land	Soldering with chassis	Use of common solder land with other SMD	Need to avoid				Recommendation			
Example	Use of common solder land	Soldering with chassis	Use of common solder land with other SMD											
Need to avoid														
Recommendation														

(12. Caution, continued)

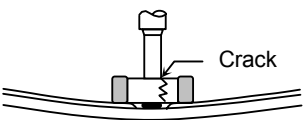
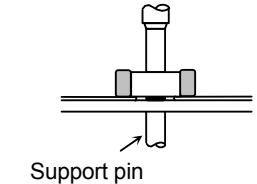
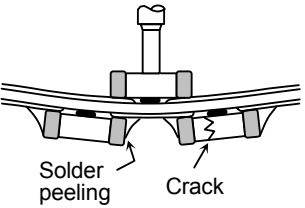
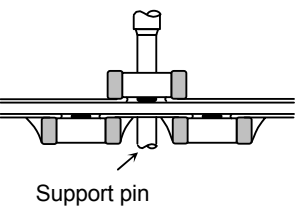
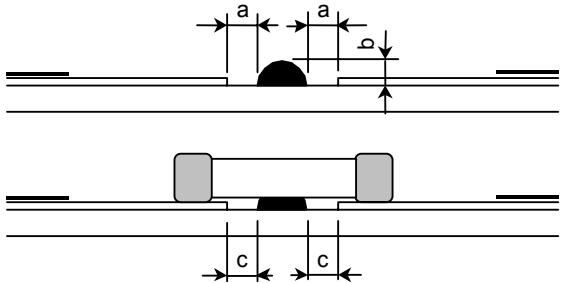
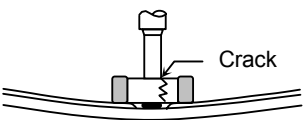
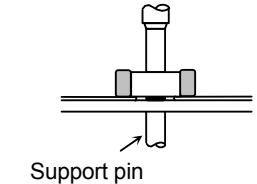
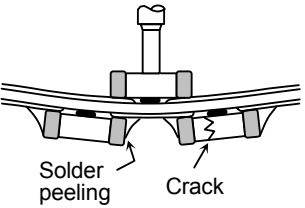
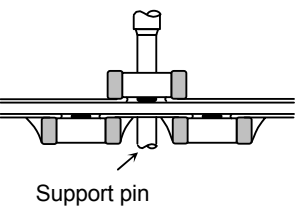
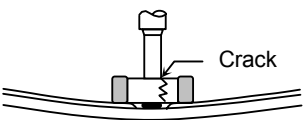
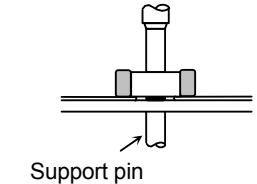
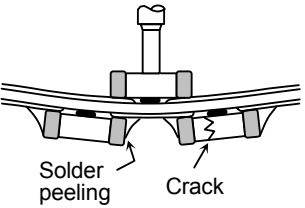
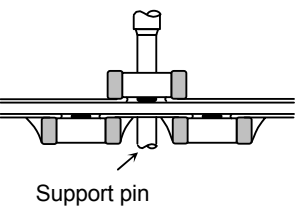
No.	Process	Condition																	
4	Mounting	<p>4.1 Stress from mounting head If the mounting head is adjusted too low, it may induce excessive stress on the chip capacitor and result in cracking. Please take following precautions.</p> <ol style="list-style-type: none"> 1. Adjust the bottom dead center of the mounting head to reach the P.C. board surface but do not contact it. 2. Adjust the mounting head pressure to be 1 to 3N of static weight. 3. To minimize the impact energy from mounting head, it is important to provide support from the bottom side of the P.C. board. See following examples. <table border="1" data-bbox="516 445 1403 974"> <thead> <tr> <th></th> <th data-bbox="695 445 1057 495">Not recommended</th> <th data-bbox="1057 445 1403 495">Recommended</th> </tr> </thead> <tbody> <tr> <td data-bbox="516 495 695 726">Single sided mounting</td> <td data-bbox="695 495 1057 726">  </td> <td data-bbox="1057 495 1403 726">  </td> </tr> <tr> <td data-bbox="516 726 695 974">Double-sided mounting</td> <td data-bbox="695 726 1057 974">  </td> <td data-bbox="1057 726 1403 974">  </td> </tr> </tbody> </table> <p>When the centering jaw is worn mechanical impact on the capacitor may occur and damage the product. Please control the closing dimension of the centering jaw and provide sufficient preventive maintenance and/or replacement if necessary.</p> <p>4.2 Amount of adhesive</p>  <table border="1" data-bbox="683 1520 1203 1713"> <tr> <td colspan="2" data-bbox="683 1520 1203 1556">Example : C2012 (CC0805), C3216 (CC1206)</td> </tr> <tr> <td data-bbox="683 1556 821 1612">a</td> <td data-bbox="821 1556 1203 1612">0.2mm min.</td> </tr> <tr> <td data-bbox="683 1612 821 1669">b</td> <td data-bbox="821 1612 1203 1669">70 - 100μm</td> </tr> <tr> <td data-bbox="683 1669 821 1713">c</td> <td data-bbox="821 1669 1203 1713">Do not touch the solder land</td> </tr> </table>		Not recommended	Recommended	Single sided mounting			Double-sided mounting			Example : C2012 (CC0805), C3216 (CC1206)		a	0.2mm min.	b	70 - 100μm	c	Do not touch the solder land
	Not recommended	Recommended																	
Single sided mounting																			
Double-sided mounting																			
Example : C2012 (CC0805), C3216 (CC1206)																			
a	0.2mm min.																		
b	70 - 100μm																		
c	Do not touch the solder land																		

(12. Caution, continued)

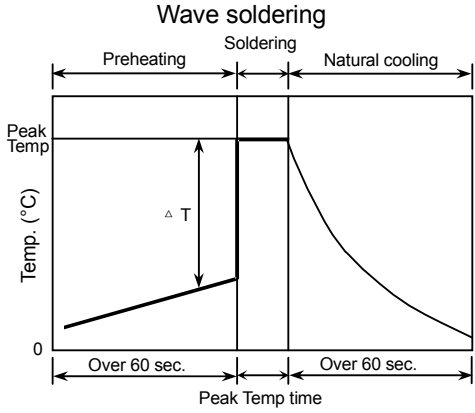
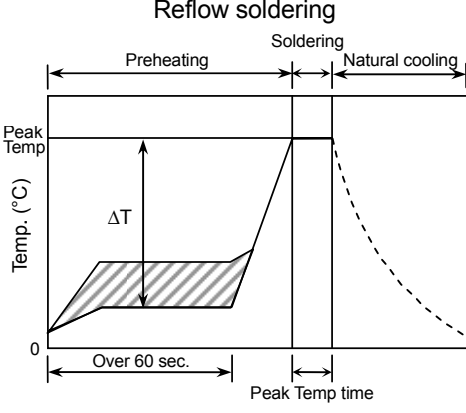
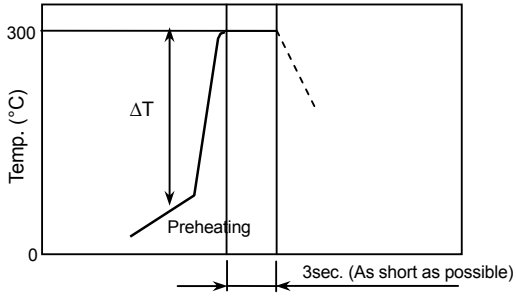
No.	Process	Condition																			
5	Soldering	<p>5.1 Flux selection</p> <p>Although highly-activated flux gives better solderability, substances which increase activity may also degrade the insulation of the chip capacitor. To avoid such degradation, the following is recommended.</p> <ol style="list-style-type: none"> 1. Use a mildly activated rosin flux (less than 0.1wt% chlorine). 2. Excessive flux must be avoided. Please provide proper amount of flux. 3. When water-soluble flux is used, sufficient washing is necessary. <p>5.2 Recommended soldering profile by various methods</p> <div style="display: flex; justify-content: space-around;"> <div style="text-align: center;"> <p>Wave soldering</p>  </div> <div style="text-align: center;"> <p>Reflow soldering</p>  </div> </div> <div style="text-align: center; margin-top: 20px;"> <p>Manual soldering (Solder iron)</p>  </div> <div style="margin-top: 20px;"> <p><u>APPLICATION</u></p> <p>As for C1608 (CC0603), C2012 (CC0805) and C3216 (CC1206), applied to wave soldering and reflow soldering.</p> <p>As for C0603 (CC0201), C1005 (CC0402), C3225 (CC1210), C4532 (CC1812), C5750 (CC2220), applied only to reflow soldering.</p> </div> <p>5.3 Recommended soldering peak temp and duration</p> <table border="1" style="width: 100%; border-collapse: collapse;"> <thead> <tr> <th rowspan="2" style="text-align: center;">Temp./Duration</th> <th colspan="2" style="text-align: center;">Wave soldering</th> <th colspan="2" style="text-align: center;">Reflow soldering</th> </tr> <tr> <th style="text-align: center;">Peak temp(°C)</th> <th style="text-align: center;">Duration(sec.)</th> <th style="text-align: center;">Peak temp(°C)</th> <th style="text-align: center;">Duration(sec.)</th> </tr> </thead> <tbody> <tr> <td style="text-align: center;">Sn-Pb Solder</td> <td style="text-align: center;">250 max.</td> <td style="text-align: center;">3 max.</td> <td style="text-align: center;">230 max.</td> <td style="text-align: center;">20 max.</td> </tr> <tr> <td style="text-align: center;">Lead Free Solder</td> <td style="text-align: center;">260 max.</td> <td style="text-align: center;">5 max.</td> <td style="text-align: center;">260 max.</td> <td style="text-align: center;">10 max.</td> </tr> </tbody> </table> <p>Recommended solder compositions</p> <p>Sn-37Pb (Sn-Pb solder)</p> <p>Sn-3.0Ag-0.5Cu (Lead Free Solder)</p>	Temp./Duration	Wave soldering		Reflow soldering		Peak temp(°C)	Duration(sec.)	Peak temp(°C)	Duration(sec.)	Sn-Pb Solder	250 max.	3 max.	230 max.	20 max.	Lead Free Solder	260 max.	5 max.	260 max.	10 max.
Temp./Duration	Wave soldering			Reflow soldering																	
	Peak temp(°C)	Duration(sec.)	Peak temp(°C)	Duration(sec.)																	
Sn-Pb Solder	250 max.	3 max.	230 max.	20 max.																	
Lead Free Solder	260 max.	5 max.	260 max.	10 max.																	

(12. Caution, continued)

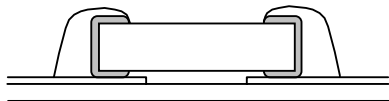
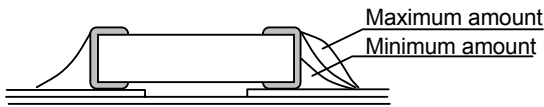
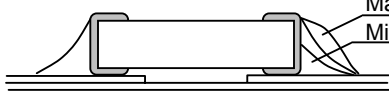
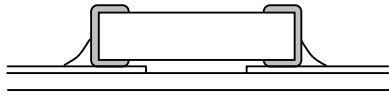
No.	Process	Condition																								
5	Soldering (continued)	<p>5.4 Avoiding thermal shock</p> <p>1. Preheating condition</p> <table border="1" data-bbox="581 289 1398 688"> <thead> <tr> <th>Soldering</th> <th>Type</th> <th>Temp. (°C)</th> </tr> </thead> <tbody> <tr> <td>Wave soldering</td> <td>C1608(CC0603), C2012(CC0805), C3216(CC1206)</td> <td>$\Delta T \leq 150$</td> </tr> <tr> <td rowspan="2">Reflow soldering</td> <td>C0603(CC0201), C1005(CC0402), C1608(CC0603), C2012(CC0805), C3216(CC1206)</td> <td>$\Delta T \leq 150$</td> </tr> <tr> <td>C3225(CC1210), C4532(CC1812), C5750(CC2220)</td> <td>$\Delta T \leq 130$</td> </tr> <tr> <td rowspan="2">Manual soldering</td> <td>C0603(CC0201), C1005(CC0402), C1608(CC0603), C2012(CC0805), C3216(CC1206)</td> <td>$\Delta T \leq 150$</td> </tr> <tr> <td>C3225(CC1210), C4532(CC1812), C5750(CC2220)</td> <td>$\Delta T \leq 130$</td> </tr> </tbody> </table> <p>2. Cooling condition Natural cooling using air is recommended. If the chips are dipped into a solvent for cleaning, the temperature difference (ΔT) must be less than 100°C.</p> <p>5.5 Amount of solder Excessive solder will induce higher tensile force on the chip capacitor during temperature changes and may result in chip cracking. Insufficient solder may detach the capacitor from the P.C. board.</p> <div style="display: flex; justify-content: space-between; align-items: flex-start;"> <div style="width: 30%;"> <p>Excessive solder</p>  </div> <div style="width: 30%; text-align: center;">  </div> <div style="width: 30%;"> <p>Higher tensile force on the chip capacitor may cause cracking.</p> </div> </div> <hr/> <div style="display: flex; justify-content: space-between; align-items: flex-start;"> <div style="width: 30%;"> <p>Adequate solder</p>  </div> <div style="width: 30%; text-align: center;"> <p>Maximum amount</p> <p>Minimum amount</p> </div> </div> <hr/> <div style="display: flex; justify-content: space-between; align-items: flex-start;"> <div style="width: 30%;"> <p>Insufficient solder</p>  </div> <div style="width: 30%;"> <p>Small solder fillet may cause contact failure or failure to hold the chip capacitor to the P.C. board.</p> </div> </div> <p>5.6 Solder repair by solder iron</p> <p>1. Selection of the soldering iron tip Tip temperatures of solder iron vary by its type, P.C. board material and solder land sizes. Higher temperatures may provide quicker operation; however, heat shock may cause a crack in the chip capacitor. Please make sure the tip temperature before soldering and keep the peak temperature and time in accordance with following recommended condition. (Please preheat the chip capacitors with the condition in 5.4 to avoid the thermal shock.)</p> <p>Recommended solder iron condition (Sn-Pb Solder and Lead Free Solder)</p> <table border="1" data-bbox="581 1759 1360 1858"> <thead> <tr> <th>Temp. (°C)</th> <th>Duration (sec.)</th> <th>Wattage (W)</th> <th>Shape (mm)</th> </tr> </thead> <tbody> <tr> <td>300 max.</td> <td>3 max.</td> <td>20 max.</td> <td>Ø 3.0 max.</td> </tr> </tbody> </table>	Soldering	Type	Temp. (°C)	Wave soldering	C1608(CC0603), C2012(CC0805), C3216(CC1206)	$\Delta T \leq 150$	Reflow soldering	C0603(CC0201), C1005(CC0402), C1608(CC0603), C2012(CC0805), C3216(CC1206)	$\Delta T \leq 150$	C3225(CC1210), C4532(CC1812), C5750(CC2220)	$\Delta T \leq 130$	Manual soldering	C0603(CC0201), C1005(CC0402), C1608(CC0603), C2012(CC0805), C3216(CC1206)	$\Delta T \leq 150$	C3225(CC1210), C4532(CC1812), C5750(CC2220)	$\Delta T \leq 130$	Temp. (°C)	Duration (sec.)	Wattage (W)	Shape (mm)	300 max.	3 max.	20 max.	Ø 3.0 max.
Soldering	Type	Temp. (°C)																								
Wave soldering	C1608(CC0603), C2012(CC0805), C3216(CC1206)	$\Delta T \leq 150$																								
Reflow soldering	C0603(CC0201), C1005(CC0402), C1608(CC0603), C2012(CC0805), C3216(CC1206)	$\Delta T \leq 150$																								
	C3225(CC1210), C4532(CC1812), C5750(CC2220)	$\Delta T \leq 130$																								
Manual soldering	C0603(CC0201), C1005(CC0402), C1608(CC0603), C2012(CC0805), C3216(CC1206)	$\Delta T \leq 150$																								
	C3225(CC1210), C4532(CC1812), C5750(CC2220)	$\Delta T \leq 130$																								
Temp. (°C)	Duration (sec.)	Wattage (W)	Shape (mm)																							
300 max.	3 max.	20 max.	Ø 3.0 max.																							

(12. Caution, continued)

	Process	Condition
5	Soldering (continued)	<p>2. Direct contact of the soldering iron with ceramic dielectric of the chip capacitor may cause cracking. Do not touch the ceramic dielectric and the terminations by solder iron.</p> <p>5.7 Sn-Zn solder Sn-Zn solder affects product reliability. Please contact TDK in advance when utilize Sn-Zn solder.</p> <p>5.8 Countermeasure for tombstone The misalignment between the mounted positions of the capacitors and the land patterns should be minimized. The tombstone phenomenon may occur especially when the capacitors are mounted (in longitudinal direction) in the same direction of the reflow soldering. (Refer to JEITA RCR-2335B Annex 1 "Recommendations to prevent the tombstone phenomenon".)</p>
6	Cleaning	<p>1. If an unsuitable cleaning fluid is used, flux residue or some foreign articles may stick to the chip capacitor surface and deteriorate insulation resistance.</p> <p>2. If cleaning condition is not suitable, it may deteriorate the chip capacitor's insulation resistance.</p> <p>2.1 Insufficient washing</p> <ol style="list-style-type: none">1. Terminal electrodes may be corroded by Halogen in the flux.2. Halogen in the flux may adhere on the surface of capacitor, and lower the insulation resistance.3. Water soluble flux has higher tendency to have above mentioned problems (1) and (2). <p>2.2 Excessive washing</p> <p>When ultrasonic cleaning is used, excessively high energy output can affect the connection between the ceramic chip capacitor's body and the terminal electrode. To avoid the, following is recommended.</p> <p style="text-align: center;">Power: 20 W/ℓmax. Frequency: 40 kHz max. Washing time: 5 minutes max.</p> <p>2.3 If the cleaning fluid is contaminated, density of Halogen can increase, and bring the same result as insufficient cleaning.</p>

(12. Caution, continued)

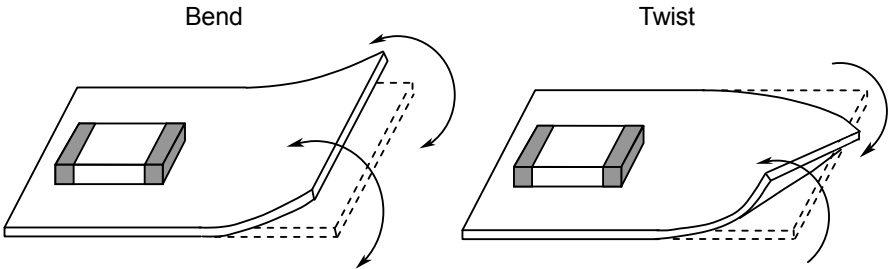
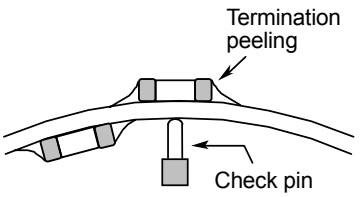
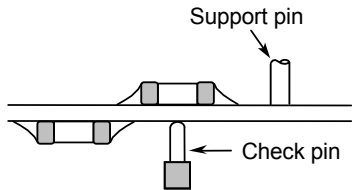
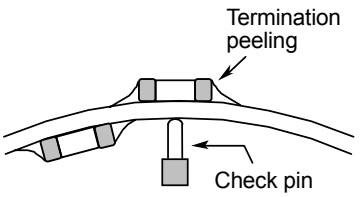
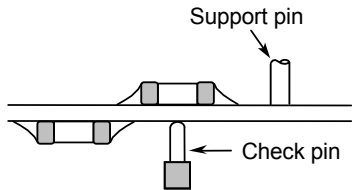
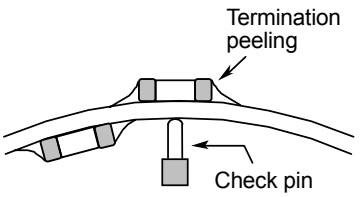
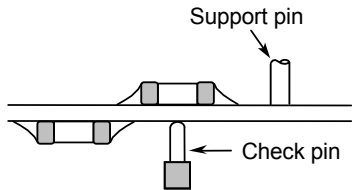
No.	Process	Condition						
7	Coating and molding of the P.C. Board	<ol style="list-style-type: none"> 1. When the P.C. board is coated, please verify the impact on the capacitor. 2. Please carefully verify that there is no harmful decomposing or reaction gas emission during curing which may damage the chip capacitor. 3. Please verify the curing temperature. 						
8	Handling after chip mounted	<ol style="list-style-type: none"> 1. Please pay attention not to bend or distort the P.C. board after soldering otherwise the chip capacitors may crack. <div style="text-align: center; margin: 10px 0;">  </div> 2. When functional check of the P.C. board is performed, higher pin pressure tends to be used for fear of loose contact. But if the pressure is excessive and bends the P.C. board, it may crack the chip capacitor or peel the termination. Please adjust the pins accordingly to ensure the P.C. board is not flexed. <table border="1" style="width: 100%; border-collapse: collapse; margin-top: 10px;"> <thead> <tr> <th data-bbox="522 1094 654 1150">Item</th> <th data-bbox="654 1094 1044 1150">Not recommended</th> <th data-bbox="1044 1094 1424 1150">Recommended</th> </tr> </thead> <tbody> <tr> <td data-bbox="522 1150 654 1430" style="text-align: center; vertical-align: middle;">Board bending</td> <td data-bbox="654 1150 1044 1430" style="text-align: center;">  </td> <td data-bbox="1044 1150 1424 1430" style="text-align: center;">  </td> </tr> </tbody> </table> 	Item	Not recommended	Recommended	Board bending		
Item	Not recommended	Recommended						
Board bending								

(12. Caution, continued)

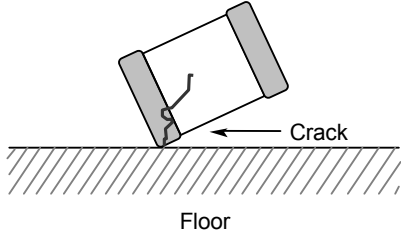
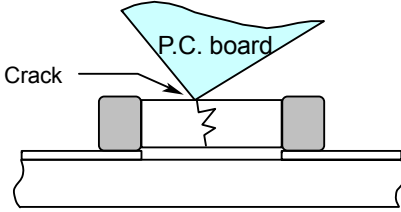
No.	Process	Condition
9	Handling of loose chip capacitors	<p>1. The chip capacitor may crack if dropped, especially the large case sizes. Please handle with care and do not use if dropped.</p>  <p>2. When stacking the P.C. board for storage or handling after soldering, the corner of the P.C. board may hit the chip capacitors of a neighboring board and cause a crack.</p> 
10	Capacitance aging	Class 2 capacitors have an aging characteristic, which is a decrease in capacitance over time due to crystalline changes that occur in ferroelectric ceramics. Careful consideration should be done in case of a time constant circuit.
11	Estimated life and estimated failure rate of capacitors	The estimated life and (failure rate) depend on the temperature and voltage applied. This can be calculated by the equation described in JEITA RCR-2335B Annex 6 "Calculation of the estimated lifetime and the estimated failure rate." The risk can be decreased by reducing the temperature and the voltage but the failure rate can not be guaranteed.
12	Others	<p>The products listed on this specification sheet are intended for use in general electronic equipment (AV equipment, telecommunications equipment, home appliances, amusement equipment, computer equipment, personal equipment, office equipment, measurement equipment, industrial robots) under a normal operation and use condition.</p> <p>The products are not designed or warranted to meet the requirements of the applications listed below, whose performance and/or quality require a more stringent level of safety or reliability, or whose failure, malfunction or trouble could cause serious damage to society, person or property. Please understand that TDK is not responsible for any damage or liability caused by use of this product in any of the applications below or for any other use exceeding the range or conditions set forth in this specification sheet:</p> <p>Aerospace/Aviation equipment. Transportation equipment (cars, electric trains, ships, etc.) Medical equipment. Power-generation control equipment. Atomic energy-related equipment. Seabed equipment. Transportation control equipment. Public information-processing equipment. Military equipment. Electric heating apparatus, burning equipment. Disaster prevention/crime prevention equipment. Safety equipment. Other applications that are not considered general-purpose applications.</p> <p>When using this product in general-purpose applications, you are kindly requested to take into consideration securing protection circuit/equipment or providing backup circuits, etc., to ensure higher safety.</p>

13. Packaging label

Packaging shall be done to protect the components from the damage during transportation and storing, and a label which has the following information shall be attached.

- 1) Inspection No.
- 2) TDK P/N
- 3) Customer's P/N
- 4) Quantity

*Composition of Inspection No.

Example M 0 A - 00 - 000
 (a) (b) (c) (d) (e)

- a) Line code
- b) Last digit of the year
- c) Month and A for January and B for February and so on. (Skip I)
- d) Inspection Date of the month.
- e) Serial No. of the day

14. Bulk packaging quantity

Total number of components in a plastic bag for bulk packaging: 1,000pcs.
As for C0603 and C1005 types, not available for bulk packaging.

15. TAPE PACKAGING SPECIFICATION

1. CONSTRUCTION AND DIMENSION OF TAPING

1. Dimensions of carrier tape

Dimensions of paper tape shall be according to Appendix 3, 4.

Dimensions of plastic tape shall be according to Appendix 5, 6.

2. Bulk part and leader of taping

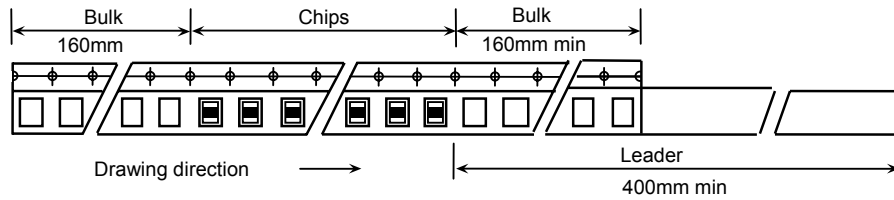

3. Dimensions of reel

Dimensions of Ø178 reel shall be according to Appendix 7, 8.

Dimensions of Ø330 reel shall be according to Appendix 9, 10.

4. Structure of taping

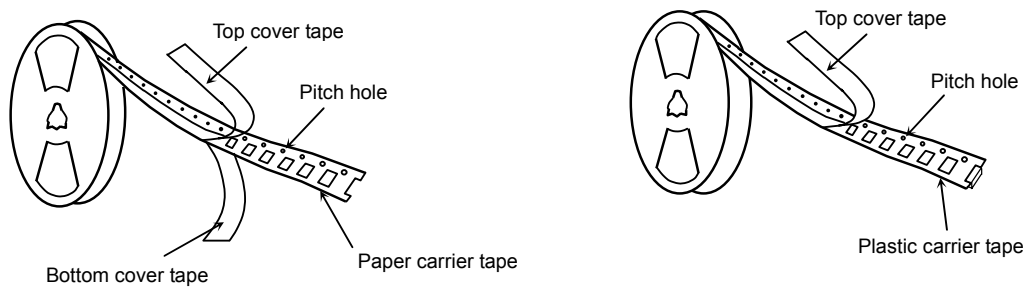

2. CHIP QUANTITY

Type	Thickness of chip	Taping Material	Chip quantity (pcs.)	
			φ178mm reel	φ330mm reel
C0402	0.20 mm	Paper	20,000	-
C0603	0.30 mm	Paper	15,000	-
C1005	0.50 mm	Paper	10,000	50,000
C1608	0.80 mm	Paper	4,000	10,000
C2012	0.60 mm	Paper	4,000	20,000
	0.85 mm	*Plastic		10,000
	1.25 mm	Plastic		2,000
C3216	0.60 mm	Paper	4,000	10,000
	0.85 mm	Paper *Plastic		
	1.15 mm	Plastic	2,000	
	1.30 mm			
	1.60 mm			
C3225	1.15 mm	Plastic	2,000	10,000
	1.25 mm		2,000	8,000
	1.30 mm			
	1.60 mm		1,000	5,000
	2.00 mm			
	2.30 mm			
	2.50 mm			
C4532	1.60 mm	Plastic	1,000	3,000
	2.00 mm		500	
	2.30 mm			
	2.50 mm			2,000
	2.80 mm			
	3.20 mm			
C5750	2.00 mm	Plastic	500	3,000
	2.30 mm			
	2.50 mm			
	2.80 mm			2,000

3. PERFORMANCE SPECIFICATIONS

1. Peel back Cover (top tape)
0.05-0.7N. (See the following figure.)

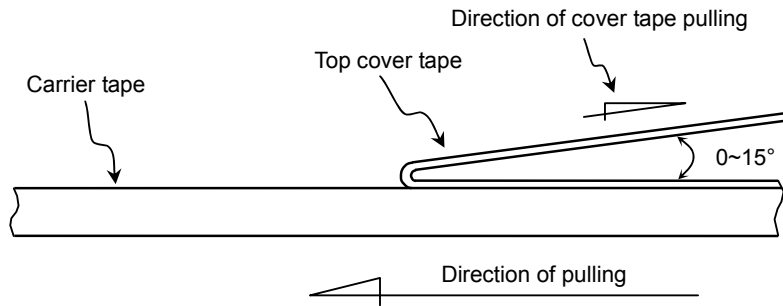

2. Carrier tape shall be flexible enough to be wound around a minimum radius of 30mm with components in tape.
3. The missing of components shall be less than 0.1%
4. Components shall not stick to the cover tape.
5. The cover tapes shall not protrude beyond the edges of the carrier tape
not shall cover the sprocket holes.

Appendix 3

Paper Tape

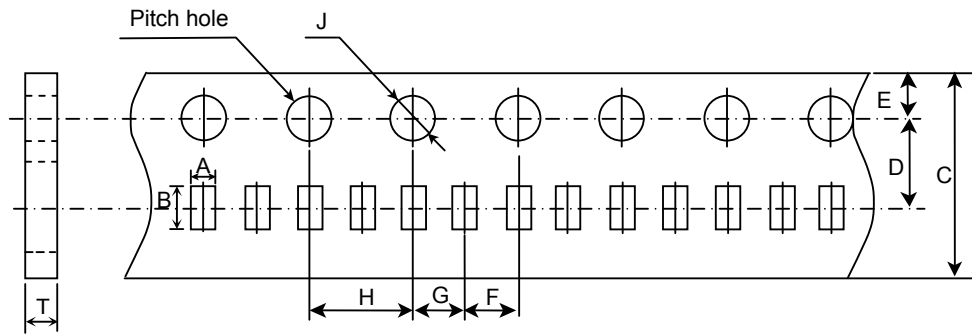

(Unit: mm)

Symbol Type	A	B	C	D	E	F
C0603 (CC0201)	(0.38)	(0.68)	8.00 ± 0.30	3.50 ± 0.05	1.75 ± 0.10	2.00 ± 0.05
C1005 (CC0402)	(0.65)	(1.15)				
C1005/4.7uF	(0.71)	(1.33)				

Symbol Type	G	H	J	T
C0603 (CC0201)	2.00 ± 0.05	4.00 ± 0.10	∅ 1.5 ^{+0.10} ₀	0.40 min.
C1005 (CC0402)				(0.60)
C1005/4.7uF				

* The values in the parentheses () are for reference.

Appendix 4

Paper Tape

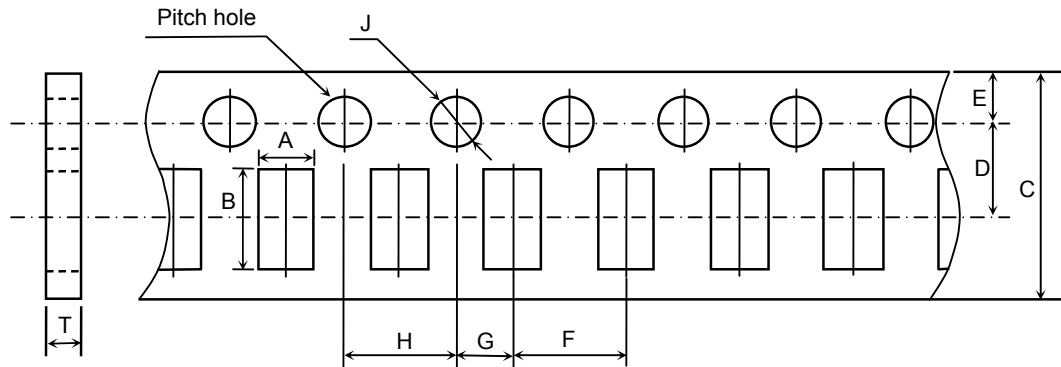

(Unit: mm)

Symbol Type	A	B	C	D	E	F
C1608 (CC0603)	(1.10)	(1.90)	8.00 ± 0.30	3.50 ± 0.05	1.75 ± 0.10	4.00 ± 0.10
C2012 (CC0805)	(1.50)	(2.30)				
C3216 (CC1206)	(1.90)	(3.50)				
Symbol Type	G	H	J	T		
C1608 (CC0603)	2.00 ± 0.05	4.00 ± 0.10	∅ 1.5 ^{+0.10} ₀	1.10 max.		
C2012 (CC0805)						
C3216 (CC1206)						

* The values in the parentheses () are for reference.

Appendix 5

Plastic Tape

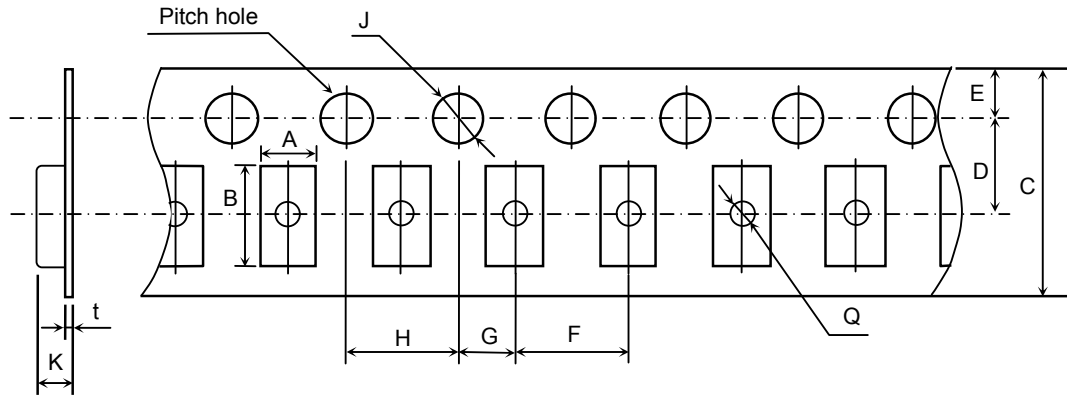

(Unit: mm)

Symbol Type	A	B	C	D	E	F
C2012 (CC0805)	(1.50)	(2.30)	8.00 ± 0.30 [12.0 ± 0.30]	3.50 ± 0.05 [5.50 ± 0.05]	1.75 ± 0.10	4.00 ± 0.10
C3216 (CC1206)	(1.90)	(3.50)				
C3225 (CC1210)	(2.90)	(3.60)				
Symbol Type	G	H	J	K	t	Q
C2012 (CC0805)	2.00 ± 0.05	4.00 ± 0.10	Ø 1.5 ^{+0.10} ₀	2.50 max.	0.30 max.	Ø 0.50 min.
C3216 (CC1206)				3.20 max.	0.60 max.	
C3225 (CC1210)						

* The values in the parentheses () are for reference.

* As for 2.5mm thickness products, apply values in the brackets [].

Appendix 6

Plastic Tape

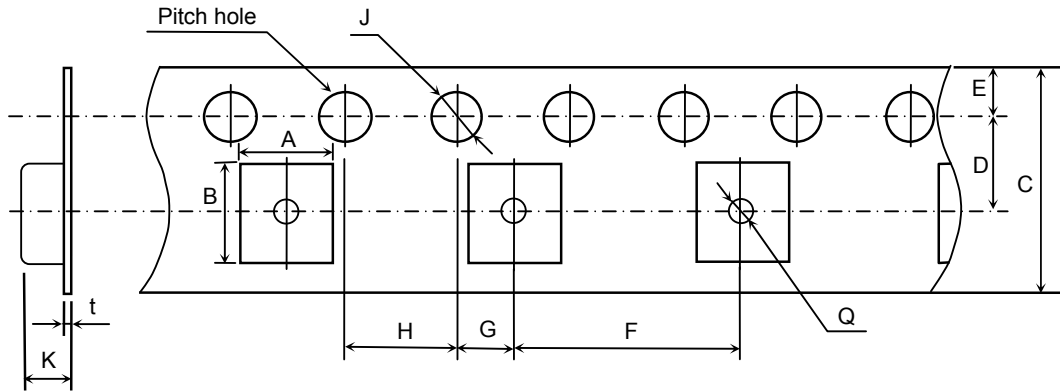

(Unit: mm)

Symbol Type	A	B	C	D	E	F
C4532 (CC1812)	(3.60)	(4.90)	12.0 ± 0.30	5.50 ± 0.05	1.75 ± 0.10	8.00 ± 0.10
C5750 (CC2220)	(5.40)	(6.10)				
Symbol Type	G	H	J	K	t	Q
C4532 (CC1812)	2.00 ± 0.05	4.00 ± 0.10	Ø 1.5 $\begin{matrix} +0.10 \\ 0 \end{matrix}$	6.50 max.	0.60 max.	Ø 1.50 min.
C5750 (CC2220)						

* The values in the parentheses () are for reference.

Appendix 7

C0603, C1005, C1608, C2012, C3216, C3225 (As for C3225 type, any thickness of the item except 2.5mm)

(Material: Polystyrene)

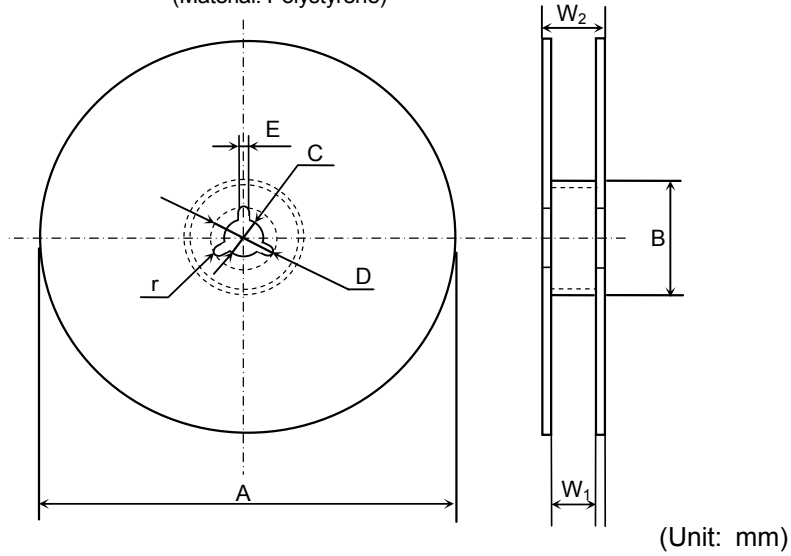

Symbol	A	B	C	D	E	W ₁
Dimension	Ø178 ± 2.0	Ø60 ± 2.0	Ø13 ± 0.5	Ø21 ± 0.8	2.0 ± 0.5	9.0 ± 0.3
Symbol	W ₂	r				
Dimension	13.0 ± 1.4	1.0				

Appendix 8

C3225, C4532, C5750 (As for C3225 type, applied to 2.5mm thickness products)

(Material: Polystyrene)

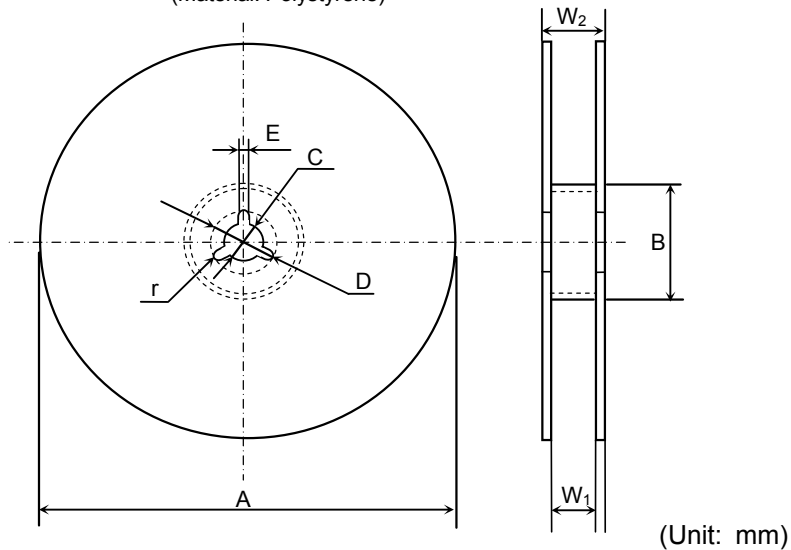

Symbol	A	B	C	D	E	W ₁
Dimension	Ø178 ± 2.0	Ø60 ± 2.0	Ø13 ± 0.5	Ø21 ± 0.8	2.0 ± 0.5	13.0 ± 0.3
Symbol	W ₂	r				
Dimension	17.0 ± 1.4	1.0				

Appendix 9

C1005, C1608, C2012, C3216, C3225 (As for C3225 type, any thickness of the item except 2.5mm)

(Material: Polystyrene)

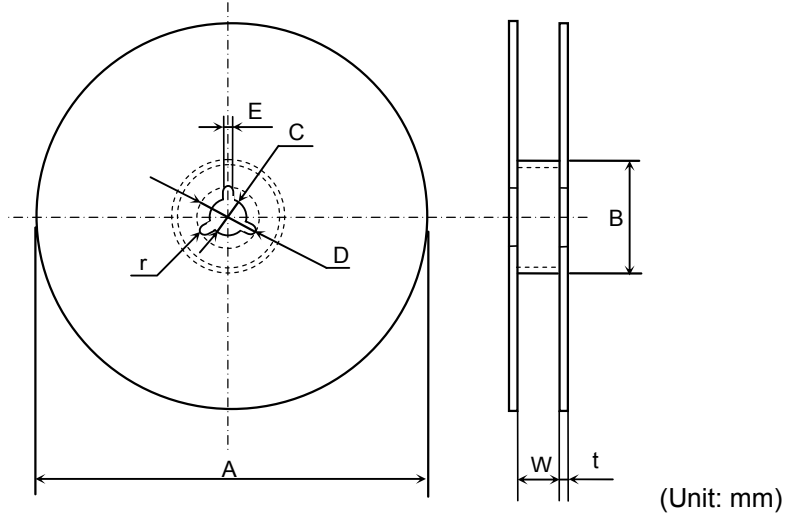

Symbol	A	B	C	D	E	W
Dimension	Ø382 max. (Nominal Ø330)	Ø50 min.	Ø13 ± 0.5	Ø21 ± 0.8	2.0 ± 0.5	10.0 ± 1.5
Symbol	t	r				
Dimension	2.0 ± 0.5	1.0				

Appendix 10

C3225, C4532, C5750 (As for C3225 type, applied to 2.5mm thickness products)

(Material: Polystyrene)

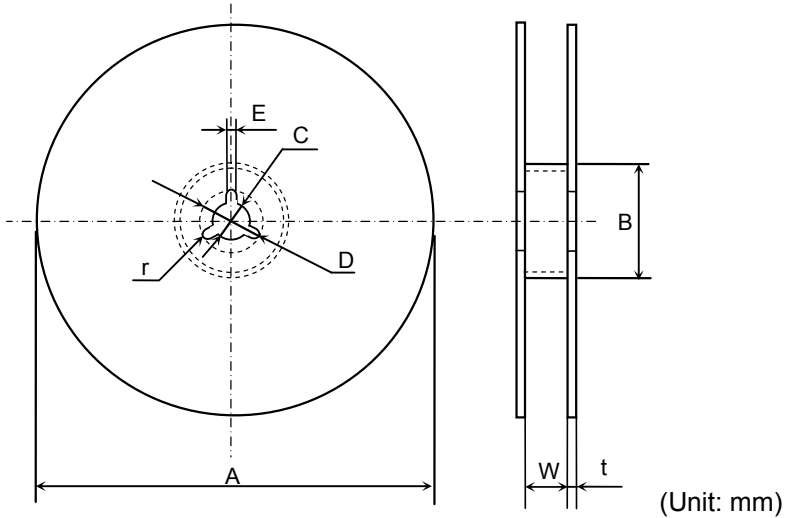

Symbol	A	B	C	D	E	W
Dimension	Ø382 max. (Nominal Ø330)	Ø50 min.	Ø13 ± 0.5	Ø21 ± 0.8	2.0 ± 0.5	14.0 ± 1.5
Symbol	t	r				
Dimension	2.0 ± 0.5	1.0				

END PAGE

Looking for pricing, stock, or lifecycle information?

Click below to explore more details on WIN SOURCE:

 [View C3216Y5V1H475Z on WIN SOURCE](#)

 [TDK Corporation Information](#)

Optimize Your Supply Chain with WIN SOURCE Solutions

-  Global Sourcing Solution
-  Obsolete Management
-  Cost Control Management
-  Shortage Management
-  Alternative Solution
-  Excess Inventory Management