



**THE DATASHEET OF
0ZCG0110AF2C**



Surface Mount PTC

OZCG Series

HF (Pb) OZCG Series – 1812 Chip

RoHS Compliant

Operating (Hold Current) Range

100mA - 3A

Product Features

- 1812 Chip Size, Fast Trip Time, Low DCR Resistance
- Full compliance with EU Directive 2011/65/EU and amending directive 2015/863
- AEC-Q Compliant
- Meets Bel automotive qualification*
* - Largely based on internal AEC-Q test plan

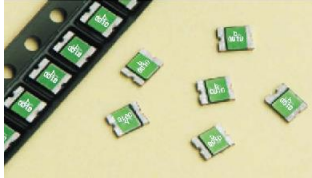

AEC-Q Compliant

Maximum Voltage

6 - 60V (per table)

Temperature Range

-40°C to 85°C

Agency Approval

TUV (Std. EN/IEC 60738-1-1 and EN/IEC 60730-1, Cert. R50102117 & R50102187)

UL Recognized Component (Std. UL1434, File E305051)

LEAD FREE = (Pb)
HALOGEN FREE = (HF)

Electrical Characteristics (23°C)

	Part Number	Hold Current	Trip Current	Rated Voltage	Maximum Current	Typical Power	Max Time to Trip		Resistance Tolerance		Agency Approvals	
		I _H , A	I _T , A	V _{max} , Vdc	I _{max} , A	P _d , W	Current A	Time Sec	R _{min} Ohms	R _{1max} Ohms	(UL US)	(TÜV)
A	0ZCG0010FF2C	0.10	0.30	60	100	0.8	8.0	0.020	1.600	15.00	Y	Y
B	0ZCG0014FF2C	0.14	0.30	60	10	0.8	8.0	0.008	1.200	6.500	Y	Y
C	0ZCG0020FF2C	0.20	0.40	30	10	0.8	8.0	0.020	0.800	5.000	Y	Y
	0ZCG0020AF2C	0.20	0.40	60	40	0.8	8.0	0.020	0.800	5.000	Y	Y
D	0ZCG0030FF2C	0.30	0.60	30	40	0.8	8.0	0.100	0.200	1.750	Y	Y
E	0ZCG0035FF2C	0.35	0.70	16	40	0.8	8.0	0.100	0.320	1.500	Y	Y
	0ZCG0035AF2C	0.35	0.70	30	40	0.8	8.0	0.100	0.320	1.500	Y	Y
F	0ZCG0050FF2C	0.50	1.00	16	100	0.8	8.0	0.150	0.150	1.000	Y	Y
	0ZCG0050AF2C	0.50	1.00	30	100	0.8	8.0	0.150	0.150	1.000	Y	Y
G	0ZCG0075FF2C	0.75	1.50	16	100	0.8	8.0	0.200	0.110	0.450	Y	Y
	0ZCG0075AF2B	0.75	1.50	24	40	1.0	8.0	0.200	0.110	0.290	Y	Y
	0ZCG0075BF2B	0.75	1.50	33	40	1.0	8.0	0.200	0.110	0.400	Y	Y
H	0ZCG0110FF2C	1.10	2.20	8	100	0.8	8.0	0.300	0.040	0.210	Y	Y
	0ZCG0110AF2C	1.10	2.20	16	100	0.8	8.0	0.500	0.060	0.180	Y	Y
	0ZCG0110BF2B	1.10	2.20	24	100	1.0	8.0	0.500	0.060	0.200	Y	Y
	0ZCG0110CF2B	1.10	2.20	33	100	0.8	8.0	0.500	0.060	0.200	Y	Y
I	0ZCG0125FF2C	1.25	2.50	6	100	0.8	8.0	0.400	0.050	0.140	Y	Y
	0ZCG0125AF2B	1.25	2.50	16	100	0.8	8.0	0.400	0.050	0.140	Y	Y
J	0ZCG0150FF2C	1.50	3.00	8	100	0.8	8.0	0.500	0.040	0.110	Y	Y
	0ZCG0150AF2C	1.50	3.00	12	100	1.0	8.0	0.500	0.040	0.110	Y	Y
	0ZCG0150BF2C	1.50	3.00	24	100	1.0	8.0	1.500	0.040	0.120	Y	Y
K	0ZCG0160FF2C	1.60	3.20	8	100	0.8	8.0	0.500	0.030	0.100	Y	Y
	0ZCG0160AF2C	1.60	3.20	12	100	1.0	8.0	1.000	0.030	0.100	Y	Y
	0ZCG0160BF2C	1.60	3.20	16	100	1.0	8.0	1.000	0.030	0.100	Y	Y
	0ZCG0160CF2C	1.60	3.20	24	100	1.0	8.0	1.000	0.030	0.100	Y	Y
L	0ZCG0200FF2C	2.00	3.50	8	100	1.0	8.0	2.000	0.020	0.070	Y	Y
	0ZCG0200AF2B	2.00	3.50	16	100	1.0	8.0	5.000	0.020	0.085	Y	Y
M	0ZCG0260FF2C	2.60	5.00	8	100	1.0	8.0	2.500	0.015	0.047	Y	Y
	0ZCG0260AF2B	2.60	5.00	13.2	100	1.3	8.0	5.000	0.015	0.050	Y	Y
	0ZCG0260BF2B	2.60	5.00	16	100	1.3	8.0	5.000	0.015	0.050	Y	Y
N	0ZCG0300FF2B	3.00	5.00	6	100	1.0	8.0	4.000	0.012	0.040	Y	Y

I_H Hold Current- The maximum current at which the device will not trip in still air at 23°C.

I_T Trip current- The minimum current at which the device will trip in still air at 23°C.

V_{max} Maximum voltage device can withstand at its rated current without suffering damage.

I_{max} Maximum fault current device can withstand at rated voltage (V_{max}) without damage.

P_d Typical power dissipated by device when in tripped state in 23°C still air environment.

R_{min} Minimum device resistance at 23°C in initial un-soldered state.

R_{1max} Maximum device resistance at 23°C, 1 hour after initial device trip, or after being soldered to PCB in end application.

PTC's – Basic Theory of Operation / “Tripped” Resistance Explanation

A Bel PTC consists of a block of polymeric material containing conductive carbon granules which is sandwiched between two conductive metal plates. When this polymer block reaches approximately 125C, either due to current passing through it via conductive chains of carbon particles or due to an external heat source; it swells volumetrically. This expansion breaks apart a majority of the chains of carbon granules that run randomly between the two conductive plates. This behavior results in a sharp increase in resistance across the two plates which all but eliminates current flow through the device, allowing just enough residual current flow to maintain the block's internal temperature at 125C. Once this “tripped” state current is cut off, the polymer brick cools and shrinks to its original size, thereby allowing its broken carbon chains to reestablish themselves and permit the part to return to its low resistance state. Once cooled to room ambient, the PTC will once again exhibit a resistance less than its “R1max” rating.

At currents below the device I_{HOLD} rating, AND at temperatures below 100C, the PTC maintains a resistance value below its R1 MAX rating.

The catalog data for each device specifies a "Typical Power" value. This is the power required to exactly match the heat lost by the tripped device to its ambient surroundings at 23C. By Ohm's Law, power can be stated as: $W = E^2/R$. Thus the approximate resistance of a “Tripped” PTC can be determined by: $R = E^2/W$, where "E" is the voltage appearing across the PTC (usually the supply's open circuit voltage), and "W" is the Typical Power value for the particular PTC.

Since the PPTC acts to maintain a constant internal temperature, its apparent resistance will change based upon applied voltage and, to a lesser degree, ambient conditions. Consider the following example....

A PTC with a Typical Power of 1 watt protecting a circuit using a 60V supply will demonstrate an apparent, tripped resistance "R" of:

$$R = 60^2/1 = 3,600 \text{ ohms}$$

This same tripped device when used to protect a 12V circuit would now present an apparent resistance of:

$$R = 12^2/1 = 144 \text{ ohms}$$

The value for Typical Power is "typical" because any physical factors that affect heat loss (such as ambient temperature or air convection) will somewhat alter the level of power that the PTC needs to maintain its internal temperature. In short, PTCs do not exhibit a constant, quantifiable tripped resistance value.

Average Time Current Characteristic Curve at 23°C

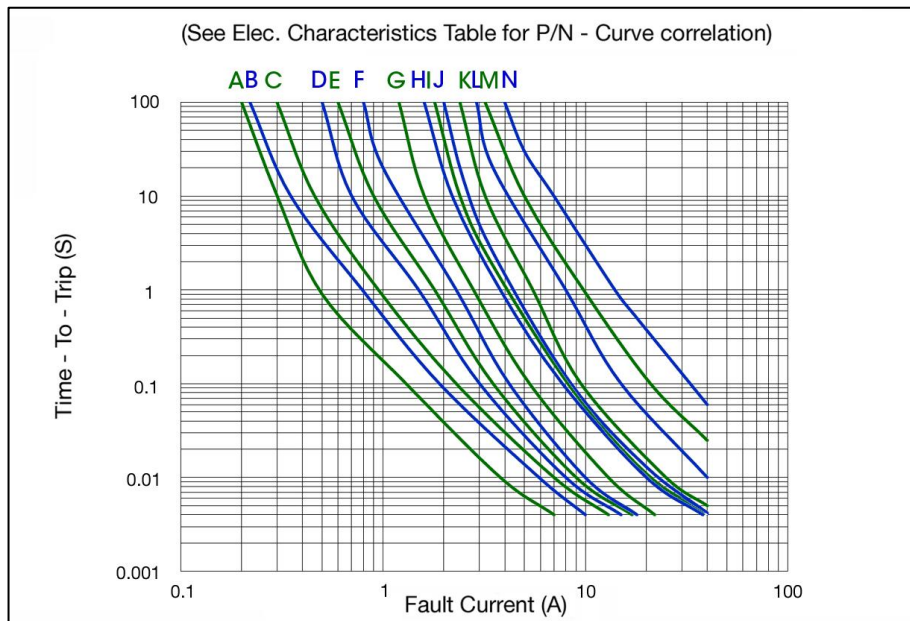

The Average Time Current Characteristic Curve and Temperature Rerating Curve are affected by a number of variables and these curves are provided for guidance only.



Specifications subject to change without notice

Bel Fuse Inc.
206 Van Vorst Street
Jersey City, NJ 07302 USA

+1 201.432.0463
Bel.US.CS@belf.com
belfuse.com/circuit-protection

Type 0ZCG Series

All dimensions in mm.

Mechanical Dimensions and Marking

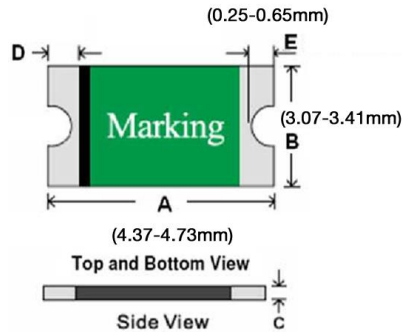

Pad Layout

The dimensions in the table below provide the recommended pad layout

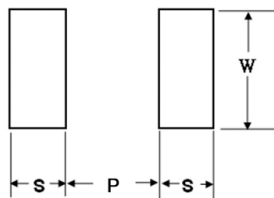

P		S		W	
Nominal		Nominal		Nominal	
mm	Inch	mm	Inch	mm	Inch
3.45	0.136	1.78	0.070	3.50	0.138

Termination Pad Materials

Matte Tin – Plated Copper

Part Number	Dimensions				Marking Code	
	C		D		"b", IH code	
	Min	Max	Min	Max		
0ZCG0010FF2C	0.60	0.90	0.30	0.95	0010	
0ZCG0014FF2C	0.60	0.90	0.30	0.95	0014	
0ZCG0020FF2C	0.60	0.90	0.30	0.95	0020	
0ZCG0020AF2C	0.60	0.90	0.30	0.95		020 60
0ZCG0030FF2C	0.40	0.70	0.30	0.95	0030	
0ZCG0035FF2C	0.40	0.70	0.30	0.95	0035	
0ZCG0035AF2C	0.40	0.70	0.30	0.95		035 30
0ZCG0050FF2C	0.35	0.65	0.30	0.95	0050	
0ZCG0050AF2C	0.45	0.75	0.30	0.95		050 30
0ZCG0075FF2C	0.35	0.65	0.30	0.95	0075	
0ZCG0075AF2B	0.80	1.55	0.25	0.95		075 24
0ZCG0075BF2B	0.80	1.55	0.25	0.95		075 33
0ZCG0110FF2C	0.25	0.55	0.30	0.95	0110	
0ZCG0110AF2C	0.25	0.90	0.30	0.95		110 16
0ZCG0110BF2B	0.80	1.30	0.25	0.95		110 24
0ZCG0110CF2B	0.80	1.30	0.25	0.95		110 33
0ZCG0125FF2C	0.25	0.55	0.30	0.95	0125	
0ZCG0125AF2B	0.50	1.00	0.30	0.95		125 16
0ZCG0150FF2C	0.25	0.55	0.30	0.95	0150	
0ZCG0150AF2C	0.60	1.10	0.25	0.95		150 12
0ZCG0150BF2C	0.60	1.55	0.25	0.95		150 24
0ZCG0160FF2C	0.25	0.90	0.30	0.95	0160	
0ZCG0160AF2C	0.60	1.35	0.25	0.95		160 12
0ZCG0160BF2C	0.60	1.35	0.25	0.95		160 16
0ZCG0160CF2C	0.55	1.20	0.25	0.95		160 24
0ZCG0200FF2C	0.55	1.20	0.25	0.95		200 A
0ZCG0200AF2B	0.60	1.55	0.25	0.95		200 16
0ZCG0260FF2C	0.55	1.20	0.25	0.95	0260	
0ZCG0260AF2B	0.80	1.55	0.25	0.95		260 13
0ZCG0260BF2B	0.80	1.55	0.25	0.95		260 16
0ZCG0300FF2B	0.80	1.55	0.25	0.95	0300	

Temperature Derating Table

I Hold Value	Temperature Derating									
	-40	-20	0	23	30	40	50	60	70	85
0010,0014 and 0020	167%	150%	133%	100%	93%	83%	73%	63%	51%	33%
0030 thru 0300	143%	129%	116%	100%	94%	86%	77%	69%	61%	48%

Thermal Derating Curve

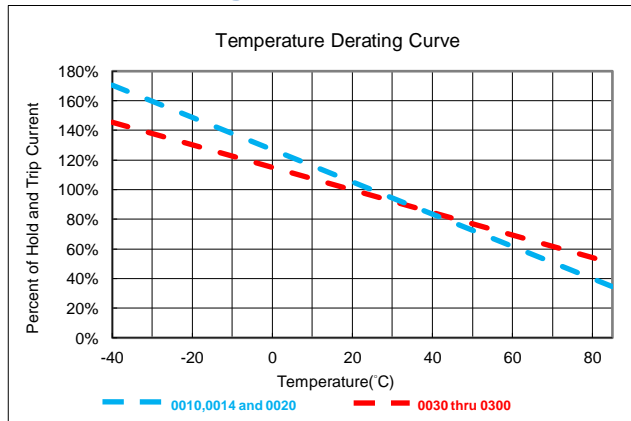

Cautionary Notes

- Operation beyond the specified maximum ratings or improper use may result in damage and possible electrical arcing and/or flame.
- These Polymer PTC (PPTC) devices are intended for protection against occasional overcurrent/overtemperature fault conditions and may not be suitable for use in applications where repeated and/or prolonged fault conditions are anticipated.
- Avoid contact of PTC device with chemical solvent. Prolonged contact may adversely impact the PTC performance.
- These PTC devices may not be suitable for use in circuits with a large inductance, as the PTC trip can generate circuit voltage spikes above the PTC rated voltage.
- These devices may be used in both DC and AC circuits provided that peak-to-peak line voltage when carrying AC does not exceed the PTC's Vmax rating. As PTCs are essentially thermal devices, the RMS value of AC current carried by a PTC will produce tripping parameters and times-to-trip similar to those of a DC voltage of the same magnitude.
- If potting is mandated, avoid rigid potting compounds as they will encase the PTC and prevent it from volumetrically expanding to properly respond to a trip event.
- MSL: 2a (According to IPC J-Std-020).



Specifications subject to change without notice

Bel Fuse Inc.
206 Van Vorst Street
Jersey City, NJ 07302 USA

+1 201.432.0463
Bel.US.CS@belf.com
belfuse.com/circuit-protection

Environmental Specifications

Temperature cycling	JESD22 Method JA-104
Biased humidity	MIL-STD-202 Method 103
Operational life	MIL-STD-202 Method 108
Resistance to solvents	MIL-STD-202 Method 215
Mechanical shock	MIL-STD-202 Method 213
Vibration	MIL-STD-202 Method 204
Resistance to soldering heat	MIL-STD-202 Method 210
Thermal shock	MIL-STD-202 Method 107
Solderability	ANSI/J-STD-002
Board flex(SMD)	AEC-Q200-005
Terminal strength	AEC-Q200-006

Solder Reflow and Rework Recommendations

Profile Feature	Pb-Free Assembly
Average Ramp-Up Rate (T _{smax} to T _p)	3°C/second max
Preheat :	
Temperature Min (T _{smin})	150°C
Temperature Max (T _{smax})	200°C
Time (t _{smin} to t _{smax})	60-180 seconds
Time maintained above:	
Temperature(T _L)	217°C
Time (t _L)	60-150 seconds
Peak/Classification Temperature(T _p) :	260°C
Time within 5°C of actual Peak :	
Temperature (t _p)	20-40 seconds
Ramp-Down Rate :	6°C/second max.
Time 25°C to Peak Temperature :	8 minutes max

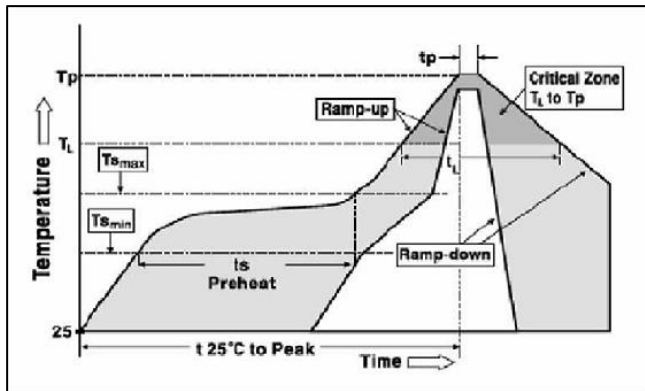

Solder Reflow

Due to "lead free / RoHS Compliant" construction of these PTC devices, the required Temperature and Dwell Time in the "Soldering" zone of the reflow profile are greater than those used for non-RoHS devices.

1. Recommended reflow methods; IR, vapor phase oven, hot air oven.
2. Not Recommended For Wave Solder / Direct Immersion.
3. Recommended paste thickness range – 0.20 – 0.25mm.
4. Devices are compatible with standard industry cleaning solvents and methods.
5. MSL: 2a (According to IPC J-Std-020).

Caution

If reflow temperature / dwell times exceed the recommended profile, the electrical performance of the PTC may be affected.

Rework: MIL-STD-202G Method 210F, Test Condition A.

Standard Packaging

Part Number	Tape/Reel Qty
0ZCG0010FF2C Thru 0ZCG0075FF2C	2,000
0ZCG0075AF2B 0ZCG0075BF2B	1,500
0ZCG0110FF2C 0ZCG0110AF2C	2,000
0ZCG0110BF2B 0ZCG0110CF2B	1,500
0ZCG0125FF2C	2,000
0ZCG0125AF2B	1,500
0ZCG0150FF2C Thru 0ZCG0200FF2C	2,000
0ZCG0200AF2B	1,500
0ZCG0260FF2C	2,000
0ZCG0260AF2B Thru 0ZCG0300FF2B	1,500

2000 or 1500 fuses
In 7 inches dia. Reel,
8mm wide tape, 4mm
pitch, per EIA-481
(equivalent
IEC-286 part 3).

P/N Explanation and Ordering Information

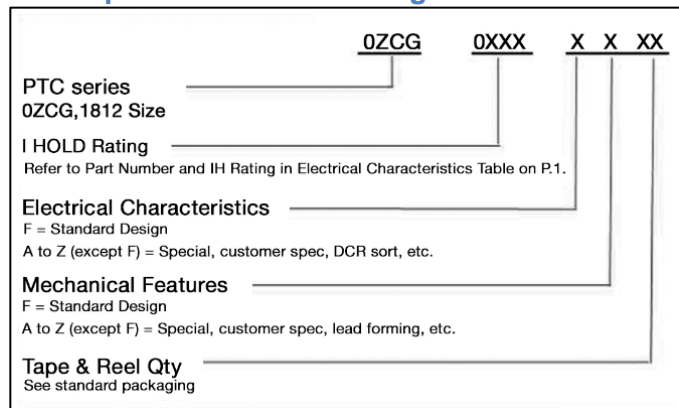

Looking for pricing, stock, or lifecycle information?

Click below to explore more details on WIN SOURCE:

 [View 0ZCG0110AF2C on WIN SOURCE](#)

 [Bel Fuse Inc. Information](#)

Optimize Your Supply Chain with WIN SOURCE Solutions

-  Global Sourcing Solution
-  Obsolete Management
-  Cost Control Management
-  Shortage Management
-  Alternative Solution
-  Excess Inventory Management