



THE DATASHEET OF RPT-38PT3F



Phototransistor, top view type

RPT-38PT3F

RPT-38PT3F is photo transistor of the top view type.

Molded with transparent resin, and can be used for visible light source. Also, can be used for illuminance sensor.

●Application

Optical control equipment
Illuminance sensor.

●Features

- 1) High sensitivity.
- 2) It can be used for visible light source.

●External dimensions (Unit : mm)

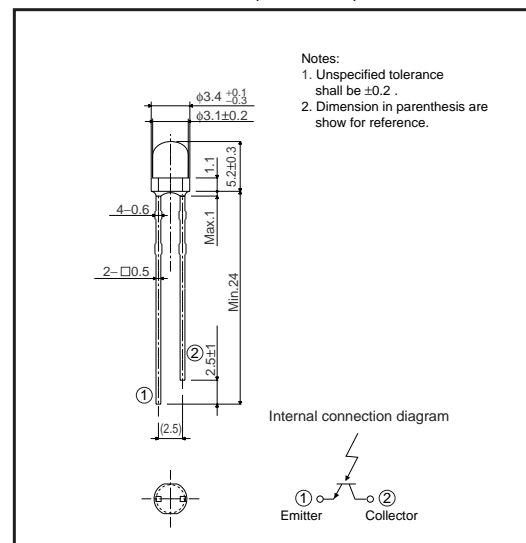

●Absolute maximum ratings (Ta = 25°C)

Parameter	Symbol	Limits	Unit
Collector-emitter voltage	V_{CE0}	32	V
Emitter-collector voltage	V_{ECO}	5	V
Collector current	I_C	30	mA
Collector power dissipation	P_C	150	mW
Operating temperature	T_{opr}	-25 to +85	°C
Storage temperature	T_{stg}	-30 to +100	°C

●Electrical and optical characteristics (Ta = 25°C)

Parameter	Symbol	Min.	Typ.	Max.	Unit	Conditions
Light current	I_C	2.0	-	-	mA	$V_{CE}=5V, E=500Lx$
Dark current	I_{CE0}	-	-	0.5	μA	$V_{CE}=10V$ (Black box)
Peak sensitivity wavelength	λ_P	-	800	-	nm	-
Collector-emitter saturation voltage	$V_{CE(sat)}$	-	-	0.4	V	$I_C=1mA, E=500Lx$
Half-angle	$\theta_{1/2}$	-	± 36	-	deg	-
Response time	$t_r \cdot t_f$	-	10	-	μs	$V_{CC}=5V, I_C=1mA, R_L=100\Omega$

Sensors

●Electrical and optical characteristic curves

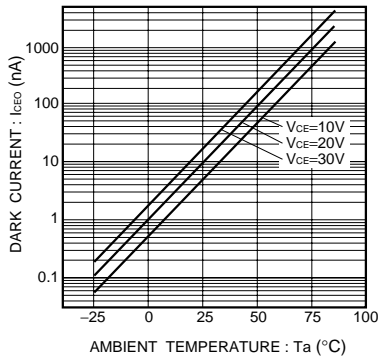

Fig.1 Dark current vs. ambient temperature

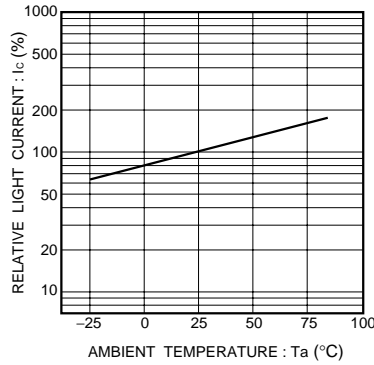

Fig.2 Relative output vs. ambient temperature

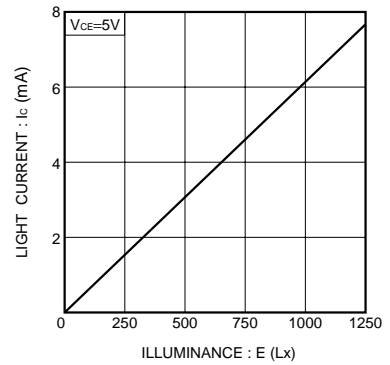

Fig.3 Light current vs. irradiance

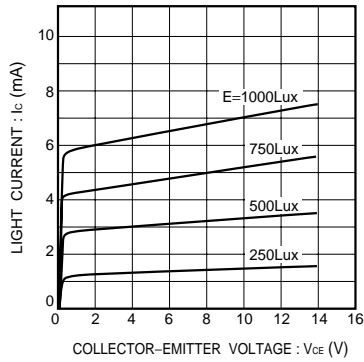

Fig.4 Output characteristics

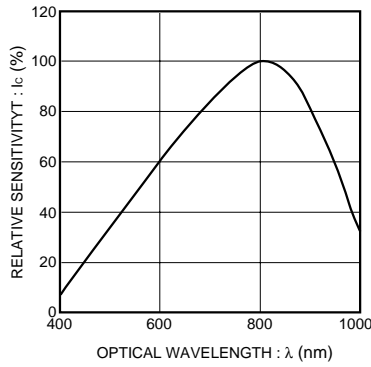

Fig.5 Spectral sensitivity

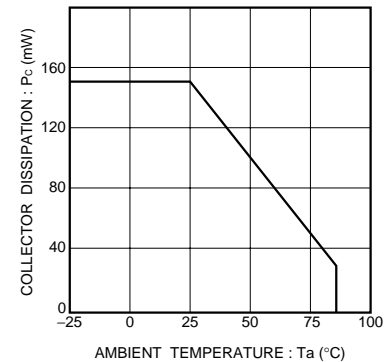

Fig.6 Collector dissipation vs. ambient temperature

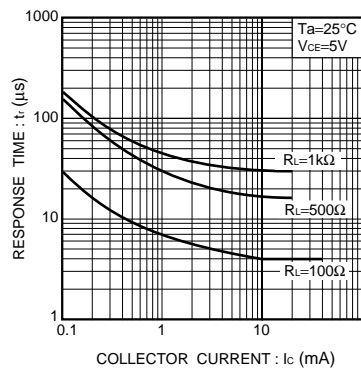

Fig.7 Response time vs. collector current

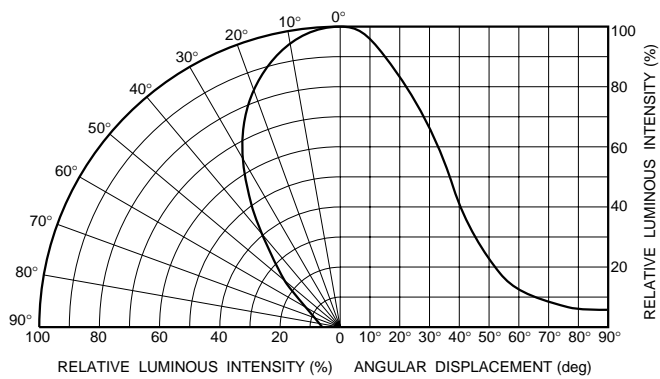

Fig.8 Directional pattern

Notes

- No technical content pages of this document may be reproduced in any form or transmitted by any means without prior permission of ROHM CO.,LTD.
- The contents described herein are subject to change without notice. The specifications for the product described in this document are for reference only. Upon actual use, therefore, please request that specifications to be separately delivered.
- Application circuit diagrams and circuit constants contained herein are shown as examples of standard use and operation. Please pay careful attention to the peripheral conditions when designing circuits and deciding upon circuit constants in the set.
- Any data, including, but not limited to application circuit diagrams information, described herein are intended only as illustrations of such devices and not as the specifications for such devices. ROHM CO.,LTD. disclaims any warranty that any use of such devices shall be free from infringement of any third party's intellectual property rights or other proprietary rights, and further, assumes no liability of whatsoever nature in the event of any such infringement, or arising from or connected with or related to the use of such devices.
- Upon the sale of any such devices, other than for buyer's right to use such devices itself, resell or otherwise dispose of the same, no express or implied right or license to practice or commercially exploit any intellectual property rights or other proprietary rights owned or controlled by
- ROHM CO., LTD. is granted to any such buyer.
- Products listed in this document are no antiradiation design.

The products listed in this document are designed to be used with ordinary electronic equipment or devices (such as audio visual equipment, office-automation equipment, communications devices, electrical appliances and electronic toys).

Should you intend to use these products with equipment or devices which require an extremely high level of reliability and the malfunction of which would directly endanger human life (such as medical instruments, transportation equipment, aerospace machinery, nuclear-reactor controllers, fuel controllers and other safety devices), please be sure to consult with our sales representative in advance.



About Export Control Order in Japan

Products described herein are the objects of controlled goods in Annex 1 (Item 16) of Export Trade Control Order in Japan.

In case of export from Japan, please confirm if it applies to "objective" criteria or an "informed" (by MITI clause) on the basis of "catch all controls for Non-Proliferation of Weapons of Mass Destruction.

Looking for pricing, stock, or lifecycle information?

Click below to explore more details on WIN SOURCE:

-  [View RPT-38PT3F on WIN SOURCE](#)
-  [Rohm Semiconductor](#) Information

Optimize Your Supply Chain with WIN SOURCE Solutions

-  Global Sourcing Solution
-  Obsolete Management
-  Cost Control Management
-  Shortage Management
-  Alternative Solution
-  Excess Inventory Management