



THE DATASHEET OF
AL5809-20S1-7



Description

The AL5809 is a constant current linear LED driver and it provides a cost-effective two pin solution. It has an excellent temperature stability of 20ppm/°C and the current accuracy $\pm 5\%$ regulated over a wide voltage and temperature range. The AL5809 comes in various fixed output current versions removing the need for external current setting resistors creating a simple solution for the linear driving of LEDs. It supports both the high-side and low-side driving of LED chains.

The AL5809 turns on when the voltage between IN and OUT swings from 2.5V up to 60V enabling it drive long LED chains. The floating ground, 60V Voltage rating between Input and Output pins designed to withstand the high peak voltage incurred in offline applications.

The AL5809 is available in either thermally robust package PowerDI123 or SOD-123 package.

Features

- 2.5V to 60V Operating Voltage Between Two Terminals
- Robust Power Package Up to 1.2W for PowerDI[®]-123
- -40°C to +125°C Temperature Range
- $\pm 5\%$ LED Current Tolerance Over-Temperature
- 15mA, 20mA, 25mA, 30mA, 40mA, 50mA, 60mA, 90mA, 100mA, 120mA, and 150mA Available in PowerDI123 Package
- 15mA, 20mA, 25mA, 30mA, 40mA and 50mA available in SOD-123 Package, Other Current Options Available by Request
- Constant Current with Low Temperature Drift and High Power Supply Rejection Ratio
- **Totally Lead-Free & Fully RoHS Compliant (Notes 1 & 2)**
- **Halogen and Antimony Free. "Green" Device (Note 3)**

Notes:

1. No purposely added lead. Fully EU Directive 2002/95/EC (RoHS) & 2011/65/EU (RoHS 2) compliant.
2. See http://www.diodes.com/quality/lead_free.html for more information about Diodes Incorporated's definitions of Halogen- and Antimony-free, "Green" and Lead-free.
3. Halogen- and Antimony-free "Green" products are defined as those which contain <900ppm bromine, <900ppm chlorine (<1500ppm total Br + Cl) and <1000ppm antimony compounds.

Pin Assignments

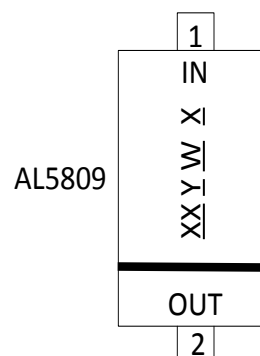

Applications

- Offline LED Lamps
- LED Power Supplies
- White Goods
- LED Signs
- Instrumentation Illumination

Typical Applications Circuit

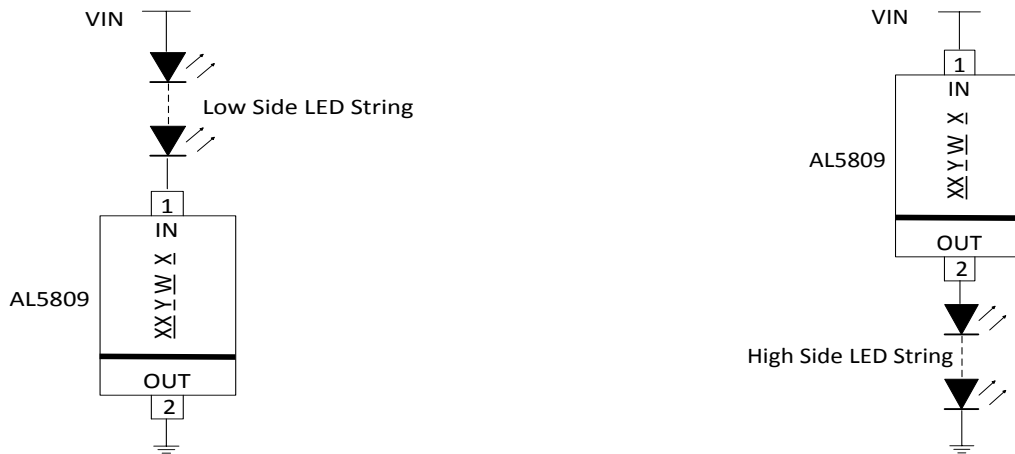

Pin Descriptions

Pin Name	Pin Number (PowerDI123)	Function
In	1	LED Current Input Terminal. For low side LED string application, connect the LED cathode terminal to the "In" terminal. For high side LED string application, connect the LED anode terminal to the "Out" terminal.
Out	2	LED Current Output Terminal. For low side LED string application, connect the LED anode terminal to the "Out" terminal. For high side LED string application, connect the LED cathode terminal to the "Out" terminal.

Functional Block Diagram

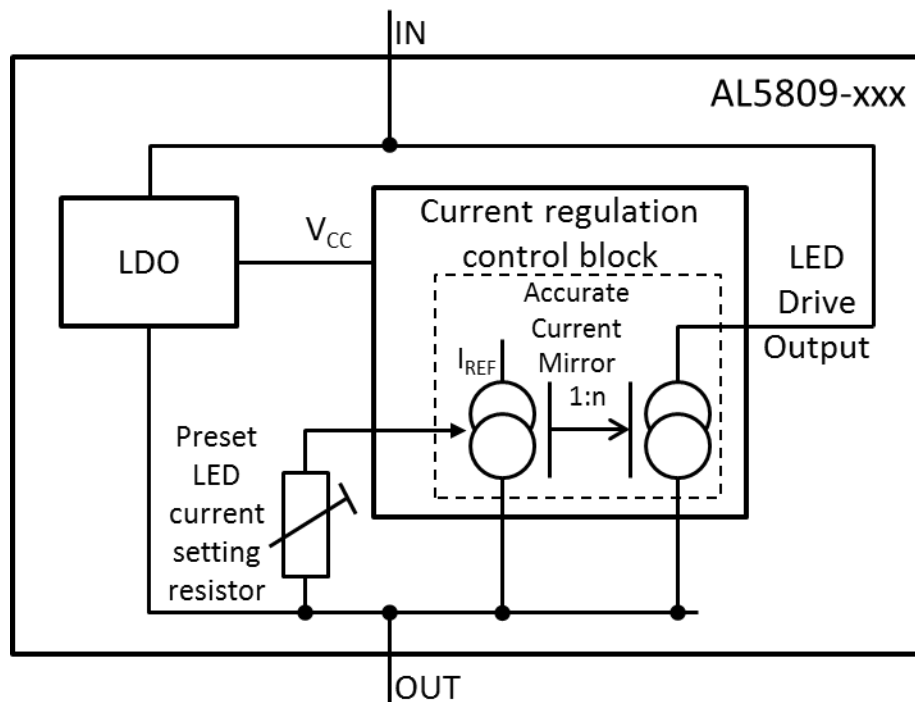

Absolute Maximum Ratings

Symbol	Parameters	Ratings	Unit
V_{InOut}	"In" Voltage Relative to "Out" Pin	-0.3 to +80	V
I_{InOut}	LED Current from "In" to "Out"	180	mA
ESD HBM	Human Body Model ESD Protection	4	kV
ESD MM	Machine Model ESD Protection	400	V
T_J	Operating Junction Temperature	-40 to +175	°C
T_{ST}	Storage Temperature	-55 to +150	°C

Caution: Stresses greater than the 'Absolute Maximum Ratings' specified above, may cause permanent damage to the device. These are stress ratings only; functional operation of the device at these or any other conditions exceeding those indicated in this specification is not implied. Device reliability may be affected by exposure to absolute maximum rating conditions for extended periods of time.
Semiconductor devices are ESD sensitive and may be damaged by exposure to ESD events. Suitable ESD precautions should be taken when handling and transporting these devices.

Package Thermal Data

Package	θ_{JC} Thermal Resistance Junction-to-Case	θ_{JA} Thermal Resistance Junction-to-Ambient	P_{DIS} $T_A = +25^\circ\text{C}, T_J = +125^\circ\text{C}$
PowerDI123	27.15°C/W	148.61°C/W (Note 4)	0.68W
PowerDI123	17.81°C/W	81.39°C/W (Note 5)	1.24W
SOD-123	69.56°C/W	278.42°C/W (Note 6)	0.36W

Recommended Operating Conditions

Symbol	Parameter	Min	Max	Unit
V_{InOut}	"In" Voltage Range Relative to "Out" Pin	2.5	60	V
I_{InOut}	LED Current (Note 7)	15	150	mA
T_A	Operating Ambient Temperature Range (Note 8)	-40	+125	°C

Electrical Characteristics ($V_{InOut} = 3.5\text{V}$) (Note 9)

Symbol	Parameter	Conditions	Min	Typ	Max	Unit
V_{InOut}	In-Out Supply Voltage	- $T_A = -40^\circ\text{C}$ to $+125^\circ\text{C}$	2.5	-	60	V
I_{InOut}	I_{InOut} Current Accuracy ($\pm 5\%$ for over temperature)	AL5809-15S1-7 AL5809-15P1-7 $T_A = -40^\circ\text{C}$ to $+125^\circ\text{C}$	14.25	15	15.75	mA
		AL5809-20S1-7 AL5809-20P1-7 $T_A = -40^\circ\text{C}$ to $+125^\circ\text{C}$	19	20	21	
		AL5809-25S1-7 AL5809-25P1-7 $T_A = -40^\circ\text{C}$ to $+125^\circ\text{C}$	23.75	25	26.25	
		AL5809-30S1-7 AL5809-30P1-7 $T_A = -40^\circ\text{C}$ to $+125^\circ\text{C}$	28.5	30	31.5	
		AL5809-40S1-7 AL5809-40P1-7 $T_A = -40^\circ\text{C}$ to $+125^\circ\text{C}$	38	40	42	
		AL5809-50S1-7 AL5809-50P1-7 $T_A = -40^\circ\text{C}$ to $+125^\circ\text{C}$	47.5	50	52.5	
		AL5809-60P1-7 $T_A = -40^\circ\text{C}$ to $+125^\circ\text{C}$	57	60	63	
		AL5809-90P1-7 $T_A = -40^\circ\text{C}$ to $+125^\circ\text{C}$	85.5	90	94.5	
		AL5809-100P1-7 $T_A = -40^\circ\text{C}$ to $+125^\circ\text{C}$	95	100	105	
		AL5809-120P1-7 $T_A = -40^\circ\text{C}$ to $+125^\circ\text{C}$	114	120	126	
AL5809-150P1-7 $T_A = -40^\circ\text{C}$ to $+125^\circ\text{C}$	142.5	150	157.5			
I_{LINE}	I_{InOut} Current Line Regulation	$V_{InOut} = 2.5\text{V}$ to 60V (Note 10) $T_A = +25^\circ\text{C}$	-	1	-	%
V_{MIN}	Minimum Power Up Voltage	Increase V_{InOut} (Note 11) $T_A = -40^\circ\text{C}$ to $+125^\circ\text{C}$	-	1.5	-	V
t_{ON_MIN}	Minimum On pulse width	(Note 12, 13)	-	500	-	μS
t_{OFF_MIN}	Minimum Off pulse width	(Note 12, 13)	-	500	-	μS
T_{SHDN}	Thermal Shutdown	Junction Temperature (Note 14)	-	-	+165	°C
T_{HYS}	Thermal Shutdown Hysteresis	-	-	-	+30	°C

- Notes:
- Test condition for PowerDI-123: Device mounted on 25.4mm x 25.4mm FR-4 PCB (10mm x 10mm 1oz copper, minimum recommended pad layout on top layer and thermal vias to bottom layer ground plane). For better thermal performance, larger copper pad for heat-sink is needed.
 - When mounted on 50.8mm x 50.8mm GETEK PCB with 25.4mm x 25.4mm copper pads.
 - Test condition for SOD-123: Device mounted on FR-4 PCB with 50.8mm x 50.8mm 2oz copper, minimum recommended pad layout on top layer and thermal vias to bottom layer with maximum area ground plane. For better thermal performance, larger copper pad for heat-sink is needed.
 - The LED operating current is determined by the AL5809 current option index XXX, AL5809-XXXS/P1-7.
 - The Maximum LED current is also limited by ambient temperature and power dissipation such that junction temperature should be kept less than or equal to $+125^\circ\text{C}$.
 - All voltages unless otherwise stated are measured with respect to OUT pin.
 - Measured by the percentage degree of LED current variation when V_{InOut} varies from 2.5V to 60V each current option.
 - Apply the power linearly to the chip until the device starts to turn on.
 - t_{ON_MIN} time includes the delay and the rise time needed for I_{OUT} to reach 90% of its final value. t_{OFF_MIN} time is the time needed for I_{OUT} to drop below 10% of its final value.
 - This parameter only guaranteed by design, not tested in production.
 - Ambient temperature at which OTP is triggered may vary depending on application, PCB layout and material used.

Application Information

Description

The AL5809 is a constant current Linear LED driver and can be placed in series with LEDs as a High Side or a Low Side constant current regulator. The AL5809 offers various current settings from 15mA up to 150mA and different current settings available upon request (contact Diodes local sales office at <http://www.diodes.com>).

The AL5809 contains a Low-Dropout regulator which provides power to the internal Current regulation control block. A fixed preset LED current setting resistor sets the reference current of the Current regulation block. The LED current setting resistor varies with each variant of the AL5809. An accurate current mirror within the Current regulation control block increases the reference current to the preset LED current of the AL5809.

Simple LED String

The AL5809 can be placed in series with LEDs as a Low Side/High Side constant current regulator. The number of the LEDs can vary from one to as many as can be supported by the input supply voltage. The designer needs to calculate the maximum voltage between In and Out by taking the maximum input voltage minus the voltage across the LED string (Figures 1 & 2).



Figure 1 Low Side LED String Tapping

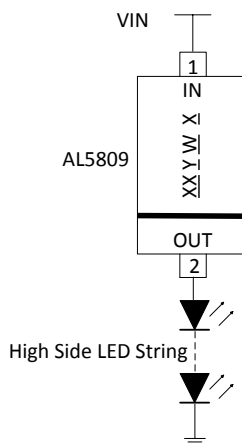
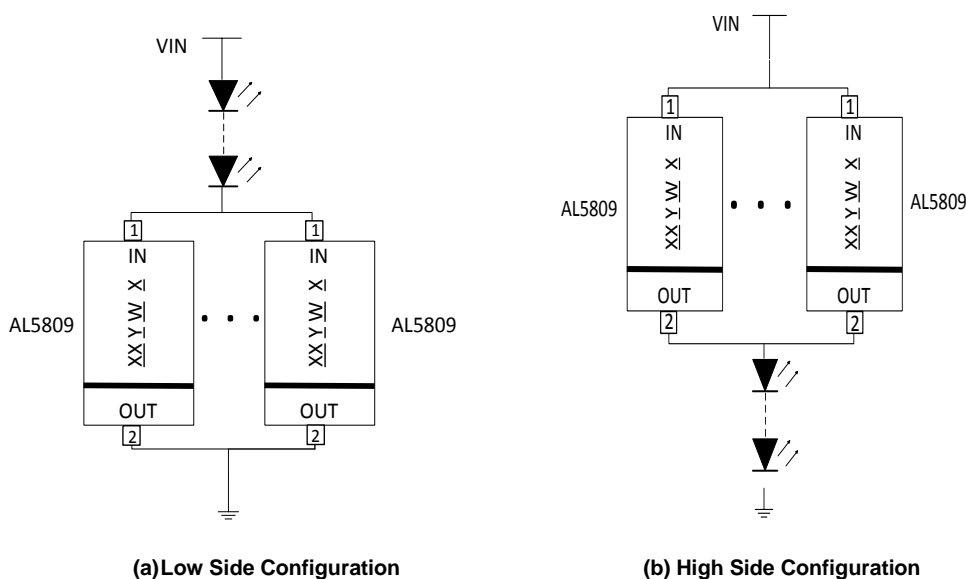

Figure 2 High Side LED String Tapping

The AL5809 can also be used on the high side of the LEDs, see Figure 2. The minimum system input voltage can be calculated by:

$$V_{IN(min)} = V_{LED_CHAIN} + 2.5V \quad \text{Where } V_{LED_CHAIN} \text{ is the LED chain voltage.}$$

The LED current can be increased by connecting two or more AL5809 in parallel in Figure 3.



(a) Low Side Configuration (b) High Side Configuration

Figure 3 Higher LED Current by Parallel Configuration of AL5809

Application Information (continued)

PWM Dimming

The AL5809 can be used to provide LED current dimming driving the Out pin via the MOSFET switch to ground (Figure 4a) applying a PWM signal with a frequency range between 100Hz and 200Hz. The Out pin current is then effectively switched on and off to modulate the output LED current. The dimming effect can be achieved by varying the PWM signal duty cycle.

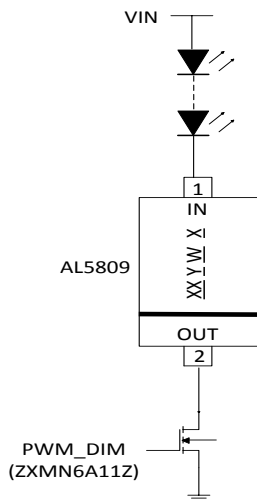

a) PWM Dimming by External MOSFET

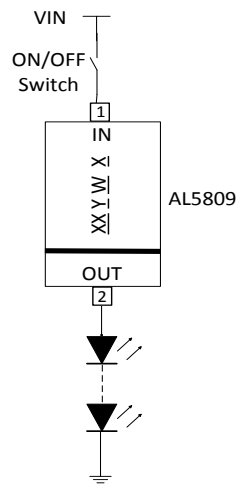

b) PWM Dimming by Power Supply VIN ON/OFF

Figure 4 PWM Dimming

Recommended PWM Frequency and Dimming Range

PWM Frequency (Hz)	Duty Cycle (%)	
	Min	Max
100	5	95
200	10	90

Test conditions (Figure 4a): PWM frequency 100Hz–200Hz Square wave, 0-4V gate voltage, VIN = 6V, 1 LED, AL5809-30mA

Use the following formula to calculate the Min and Max duty cycle:

Min. Duty cycle (%) = $t_{ON_MIN} / (\text{time period of the PWM signal})$
 Max. Duty cycle (%) = $100\% - ((t_{OFF_MIN} / (\text{time period of the PWM signal}))$

Notes: $t_{ON_MIN} = 0.5\text{mS}$ (Min. value), and $t_{OFF_MIN} = 0.5\text{mS}$ (Min. value) are listed in the Electrical Characteristics table on page 4.

Application Information (continued)

Dimming Curves

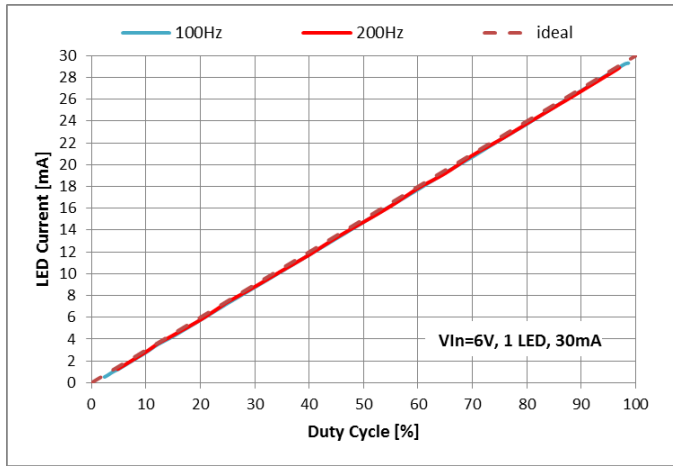

Figure 5 PWM Dimming 30mA vs. Duty Cycle

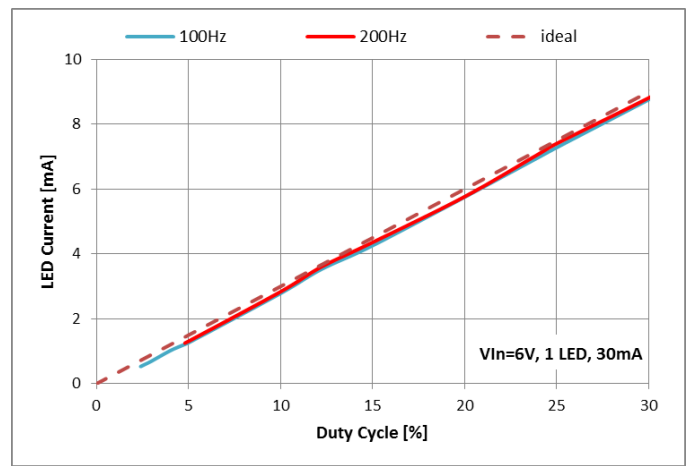

Figure 6 Area Zoom In within Duty Cycle 30% of Figure 5

Recommended Minimum On/Off Pulse Width

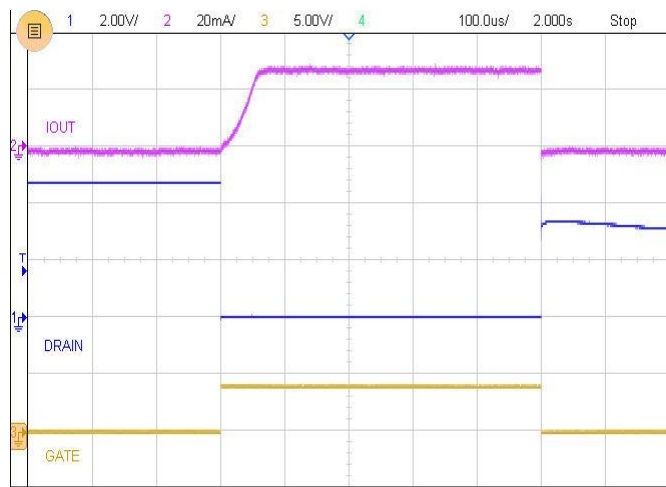

Figure 7 Minimum On Pulse Width (t_{ON_MIN})

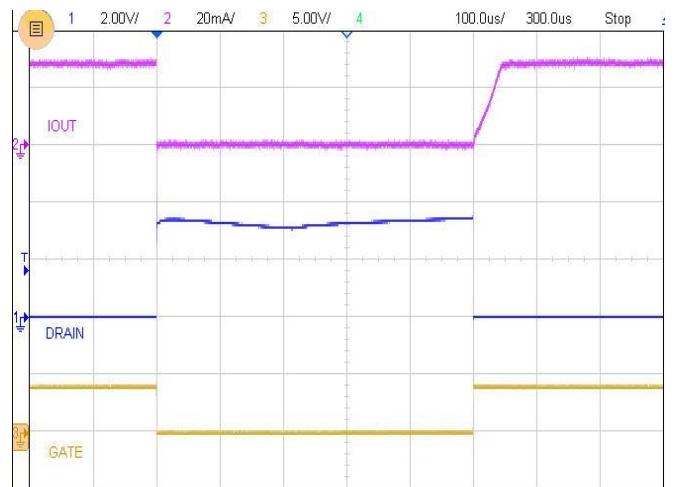

Figure 8 Minimum Off Pulse Width (t_{OFF_MIN})

Application Information (cont.)

Power Dissipation

The maximum ambient temperature range of the AL5809 is determined by its power dissipation and thermal impedance of the PCB onto which it is mounted. Its junction temperature must be kept equal to or less than +125°C.

The power dissipated is determined by the LED current version that has been selected (15, 20, 25 30, 40, 50, 60, 90, 100, 120 or 150mA) and the difference between the input voltage and LED chain voltage.

$$V_{INOUT} * I_{LED}$$

In a typical 12V system, the input voltage can vary between 11.4V and 12.6V. The recommended minimum V_{INOUT} voltage of 2.5V enables the AL5809 to drive 2 LED in series from the 12V rail (assuming $V_{LED} < 3.25V$).

The AL5809's power dissipation under minimum input voltage conditions will be:
So for the 20mA AL5809-20PI under these conditions this equals:

$$V_{INOUT} * I_{LED} = (11.4-6.5) * I_{LED}$$

$$4.9V * 20mA = 98mW$$

Under maximum input conditions (12.6V) the AL5809's power dissipation will be:
So for the 20mA AL5809-20QPI this equals:

$$V_{INOUT} * I_{LED} = (12.6-6.5) * I_{LED}$$

$$6.1V * 20mA = 122mW$$

So there is a large difference in power dissipation of the Linear LED driver between minimum and maximum battery voltages. And care must be taken to calculate expected power dissipations and then determine the suitable PCB material and layout. See Figures 9, 10 and 11 for graphs showing power dissipation and maximum V_{INOUT} , for different currents and PCB material. Maximizing the area and mass of the ground plane and additional vias between the pad of the OUT pin will improve the thermal impedance (θ_{JA}) of the AL5809.

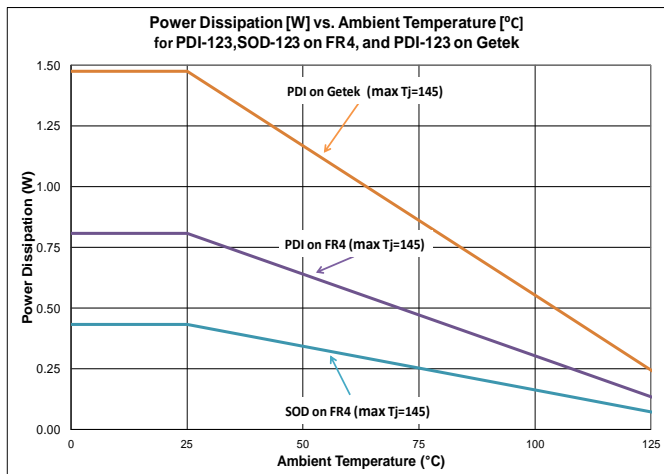

Figure 9 Power Dissipation vs. Ambient Temperature @T_J = +145°C

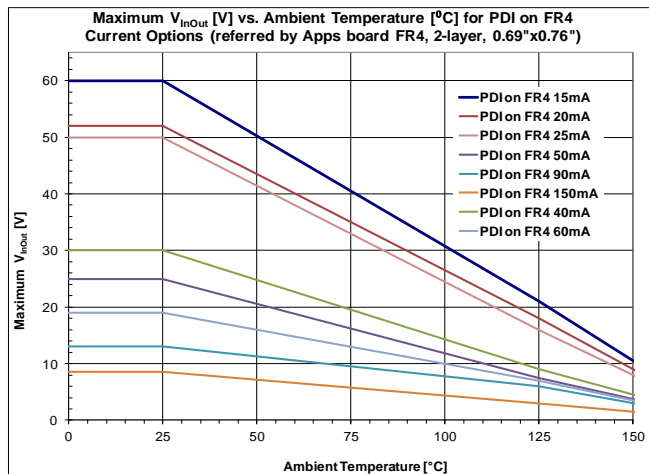

Figure 10 Maximum V_{INOut} vs. Temperature

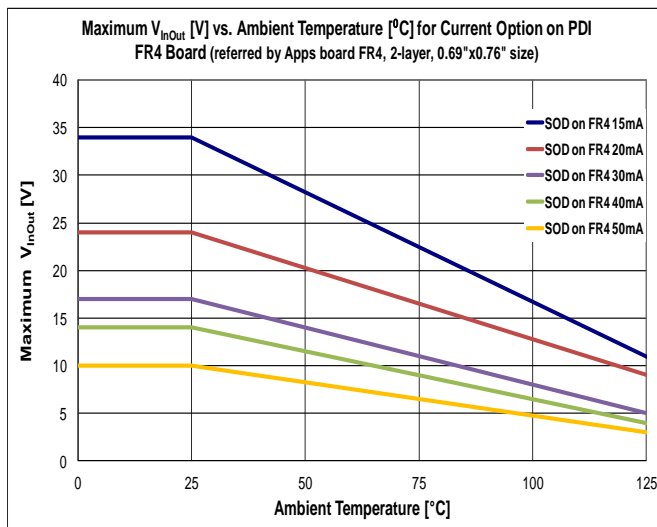

Figure 11 Maximum V_{INOut} vs. Temperature

Application Information (cont.)

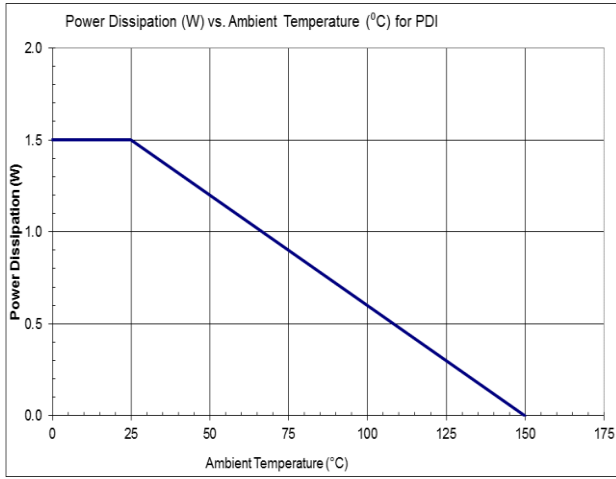

Figure 12 Power Dissipation vs. Ambient Temperature

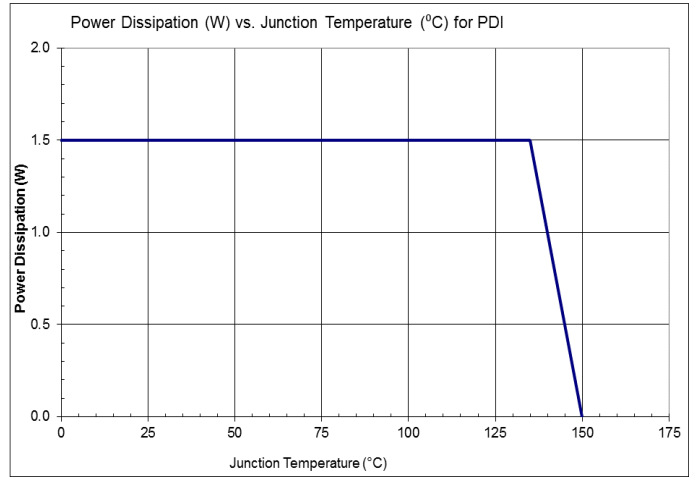

Figure 13 Power Dissipation vs. Junction Temperature

Typical Performance Characteristics (15mA, 20mA, 25mA, 30mA, 40mA, 50mA PowerDI options)

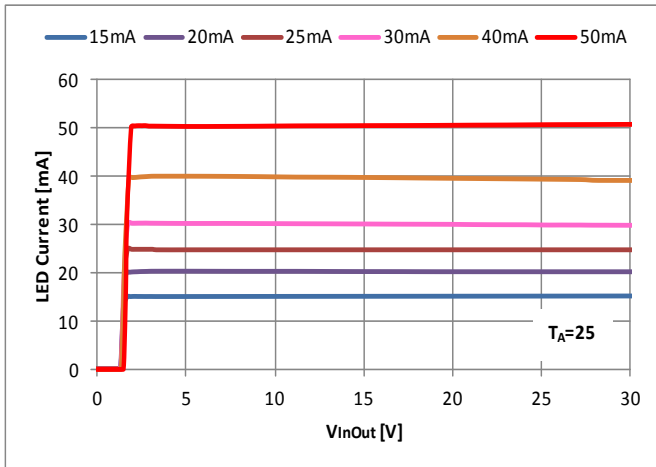

Figure 14 LED Current vs. VinOut

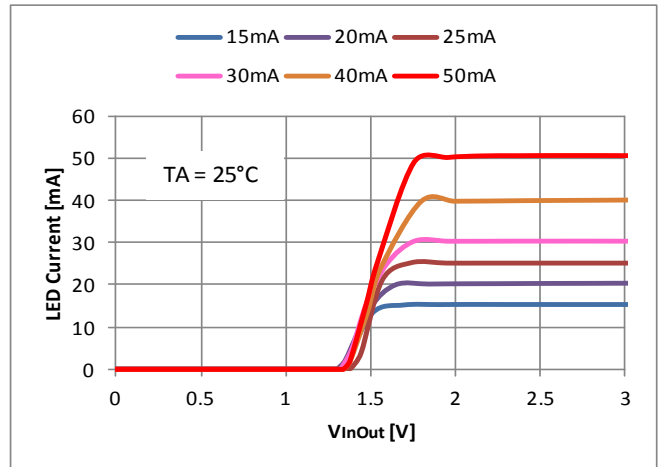

Figure 15 Startup Minimum Operating Voltage

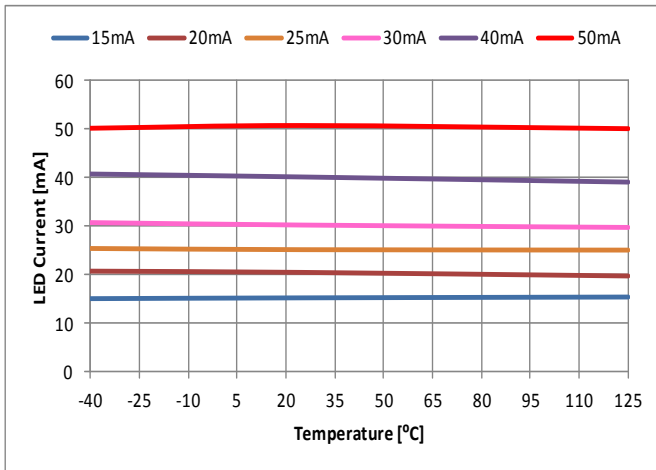

Figure 16 LED Current vs. Ambient Temperature

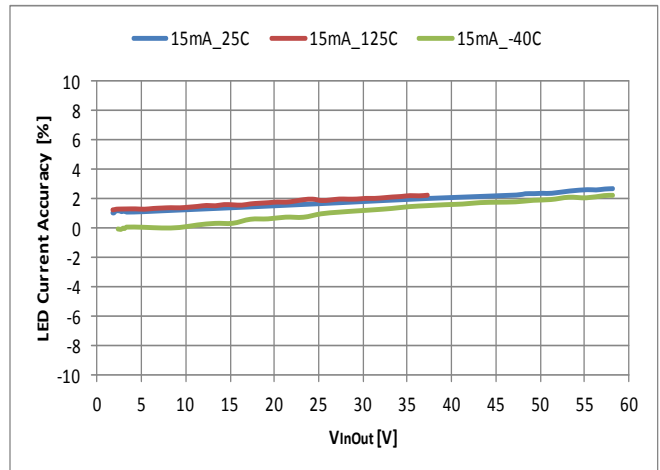

Figure 17 LED Current Accuracy (%) vs. VinOut across Temperature

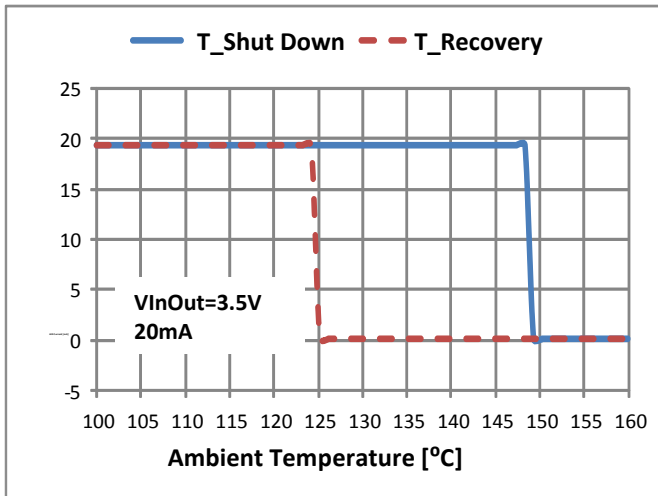

Figure 18 THSD of 20mA Current Option

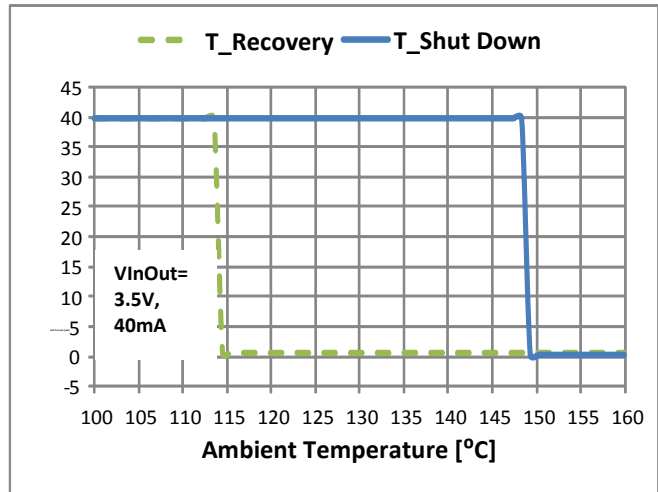

Figure 19 THSD of 40mA Current Option

Typical Performance Characteristics (continued) (60mA, 90mA, 150mA PowerDI options)

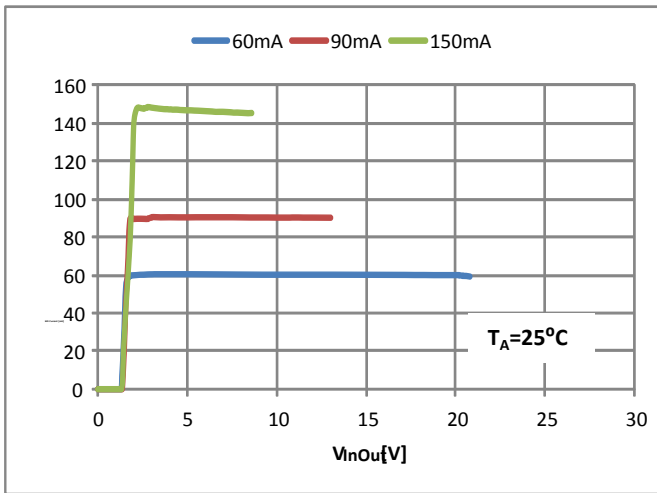

Figure 20 LED Current vs. VinOut

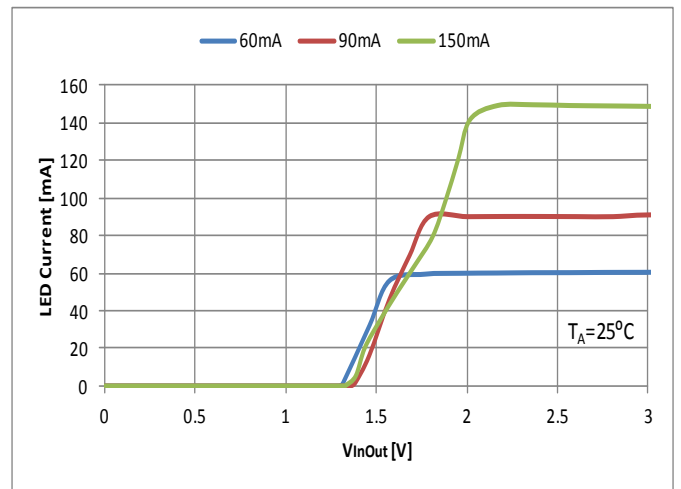

Figure 21 Startup Minimum Operating Voltage

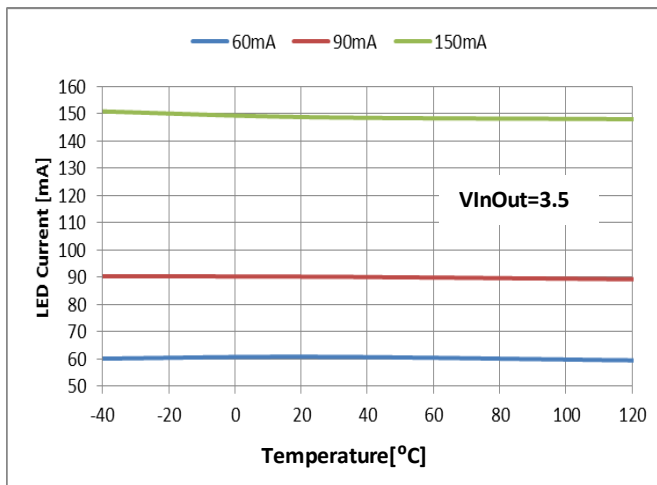

Figure 22 LED Current across Temperature

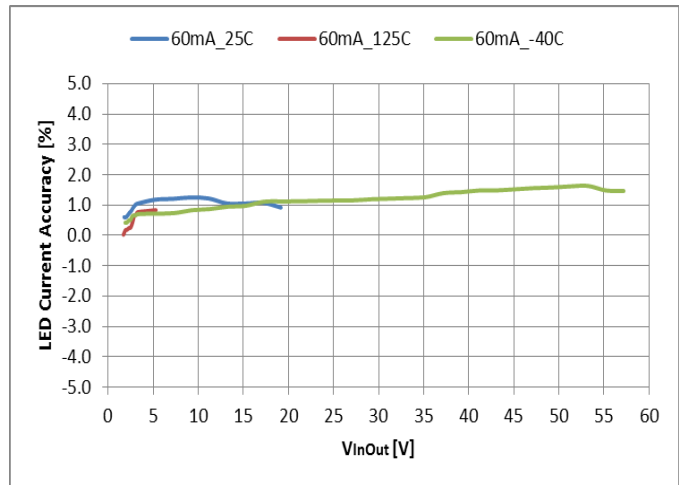

Figure 23 LED Current Accuracy (%) vs. VinOut across Temperature

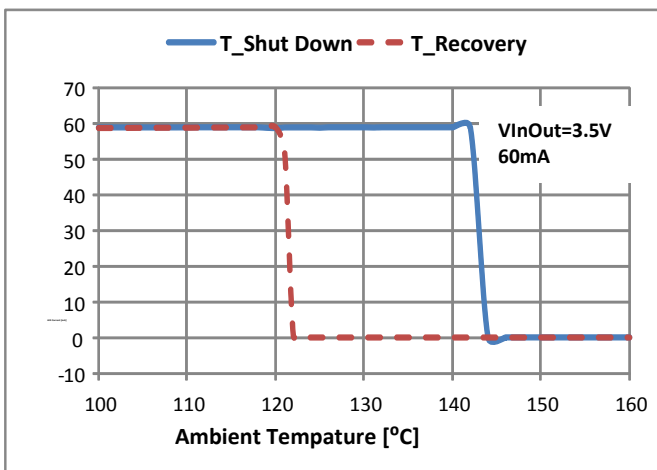

Figure 24 THSD of 60mA Current Option

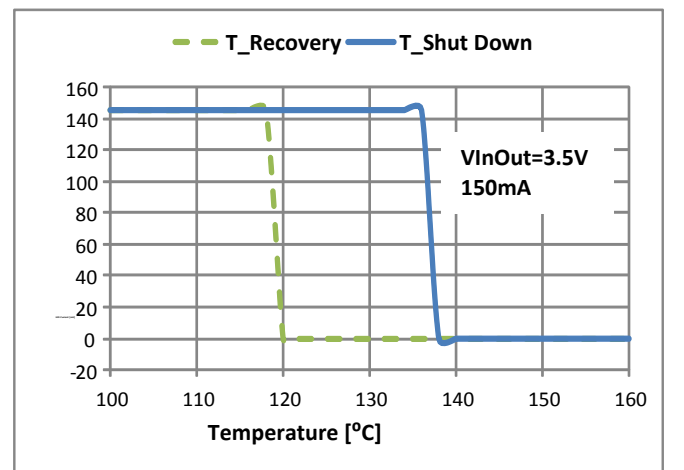
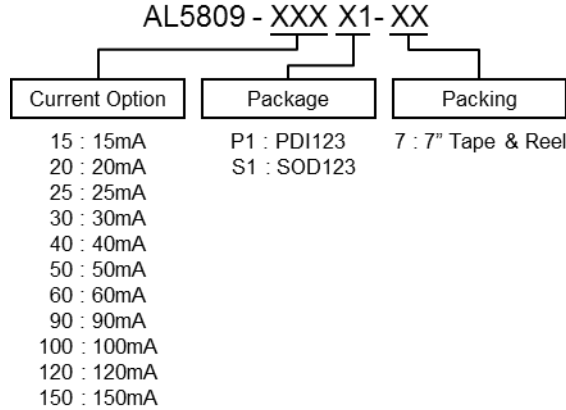

Figure 25 THSD of 150mA Current Option

Ordering Information



	Part Number	LED Current Option	Package Code	Packaging	7" Tape and Reel	
					Quantity	Part Number Suffix
	AL5809-15P1-7	15mA	P1	PowerDI123	3,000/ Tape & Reel	-7
	AL5809-15S1-7		S1	SOD-123	3,000/ Tape & Reel	-7
	AL5809-20P1-7	20mA	P1	PowerDI123	3,000/ Tape & Reel	-7
	AL5809-20S1-7		S1	SOD-123	3,000/ Tape & Reel	-7
	AL5809-25P1-7	25mA	P1	PowerDI123	3,000/ Tape & Reel	-7
	AL5809-25S1-7		S1	SOD-123	3,000/ Tape & Reel	-7
	AL5809-30P1-7	30mA	P1	PowerDI123	3,000/ Tape & Reel	-7
	AL5809-30S1-7		S1	SOD-123	3,000/ Tape & Reel	-7
	AL5809-40P1-7	40mA	P1	PowerDI123	3,000/ Tape & Reel	-7
	AL5809-40S1-7		S1	SOD-123	3,000/ Tape & Reel	-7
	AL5809-50P1-7	50mA	P1	PowerDI123	3,000/ Tape & Reel	-7
	AL5809-50S1-7		S1	SOD-123	3,000/ Tape & Reel	-7
	AL5809-60P1-7	60mA	P1	PowerDI123	3,000/ Tape & Reel	-7
	AL5809-90P1-7	90mA	P1	PowerDI123	3,000/ Tape & Reel	-7
	AL5809-100P1-7	100mA	P1	PowerDI123	3,000/ Tape & Reel	-7
	AL5809-120P1-7	120mA	P1	PowerDI123	3,000/ Tape & Reel	-7
	AL5809-150P1-7	150mA	P1	PowerDI123	3,000/ Tape & Reel	-7

Marking Information

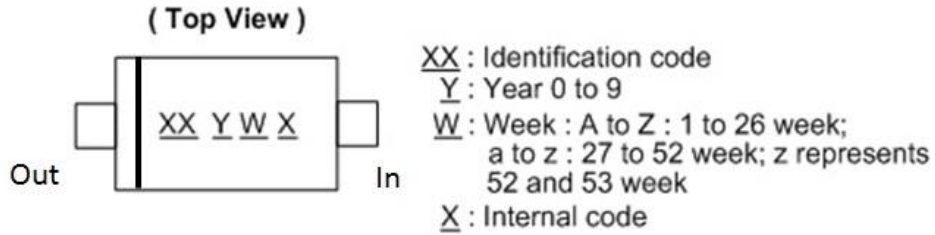

Part Number	Package	Identification Code
AL5809-15P1-7	PowerDI123	C1
AL5809-20P1-7	PowerDI123	C2
AL5809-25P1-7	PowerDI123	CA
AL5809-30P1-7	PowerDI123	C3
AL5809-40P1-7	PowerDI123	C4
AL5809-50P1-7	PowerDI123	C5
AL5809-60P1-7	PowerDI123	C6
AL5809-90P1-7	PowerDI123	C7
AL5809-100P1-7	PowerDI123	CB
AL5809-120P1-7	PowerDI123	C8
AL5809-150P1-7	PowerDI123	C9
AL5809-15S1-7	SOD-123	D1
AL5809-20S1-7	SOD-123	D2
AL5809-25S1-7	SOD-123	DA
AL5809-30S1-7	SOD-123	D3
AL5809-40S1-7	SOD-123	D4
AL5809-50S1-7	SOD-123	D5

Package Outline Dimensions

Please see <http://www.diodes.com/package-outlines.html> for the latest version.

PowerDI123 (Type B)

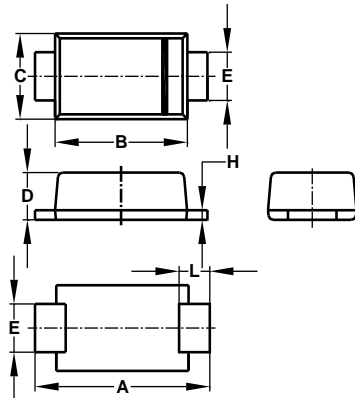

PowerDI123 Type B			
Dim	Min	Max	Typ
A	3.50	3.90	3.70
B	2.60	3.00	2.80
C	1.63	1.93	1.78
D	0.93	1.00	0.98
E	0.85	1.25	1.00
H	0.15	0.25	0.20
L	0.50	0.80	0.65
All Dimensions in mm			

Package Outline Dimensions (continued)

Please see <http://www.diodes.com/package-outlines.html> for the latest version.

SOD123

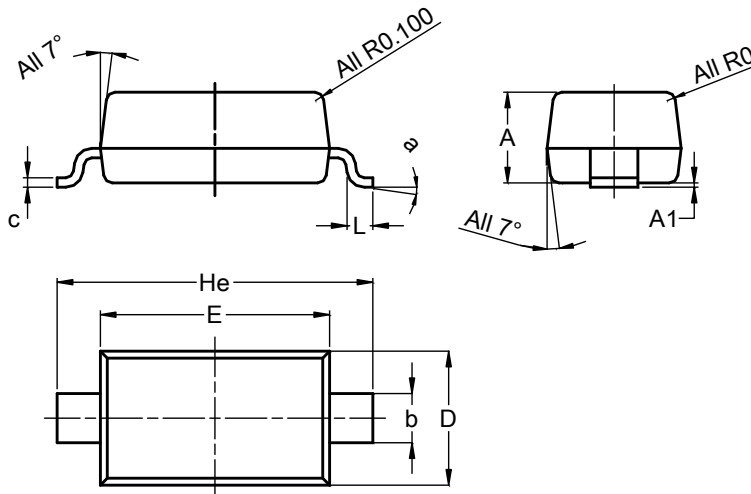

SOD123			
Dim	Min	Max	Typ
A	1.00	1.35	1.05
A1	0.00	0.10	0.05
b	0.52	0.62	0.57
c	0.10	0.15	0.11
D	1.40	1.70	1.55
E	2.55	2.85	2.65
He	3.55	3.85	3.65
L	0.25	0.40	0.30
a	0°	8°	--
All Dimensions in mm			

Suggested Pad Layout

Please see <http://www.diodes.com/package-outlines.html> for the latest version.

PowerDI123 (Type B)

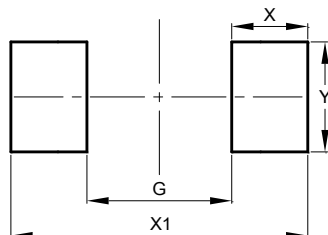

Dimensions	Value (in mm)
G	2.000
X	1.050
X1	4.100
Y	1.500

SOD123

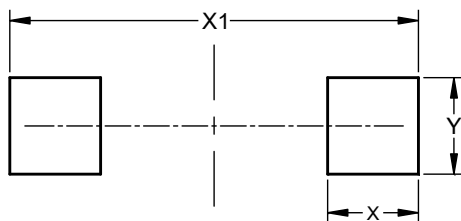

Dimensions	Value (in mm)
X	0.900
X1	4.050
Y	0.950

Taping Orientation

The taping orientation of the other package type can be found on our website at <http://www.diodes.com/datasheets/ap02007.pdf>.

PowerDI123 (Type B)



SOD123

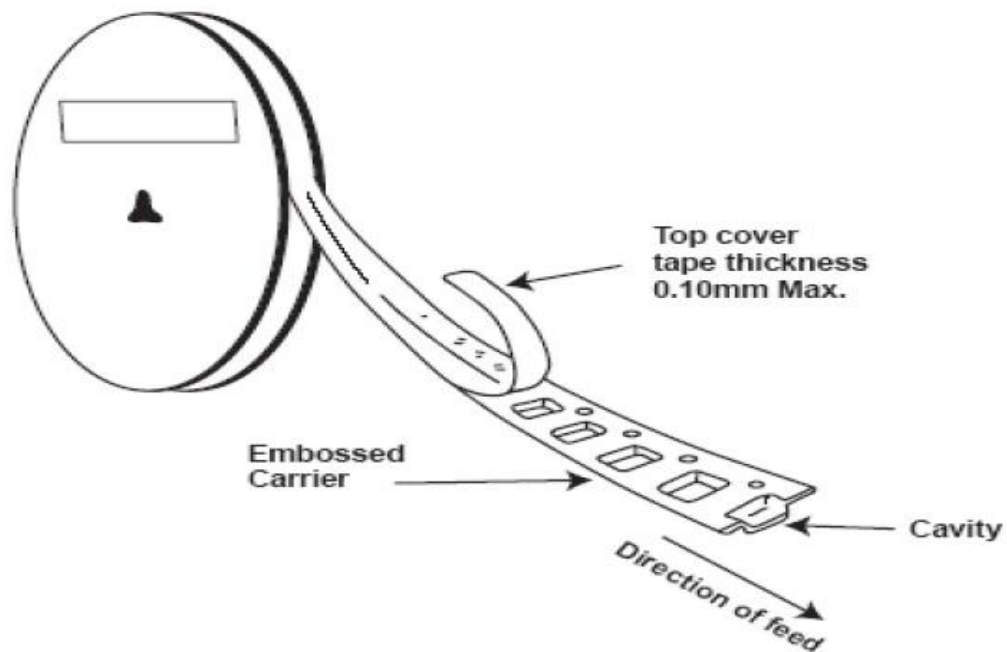
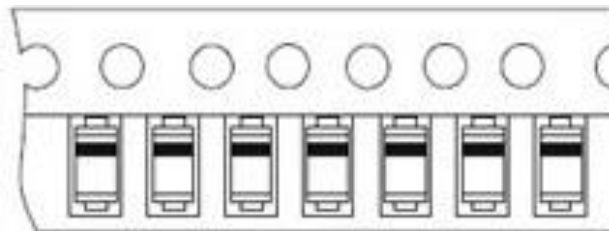

IMPORTANT NOTICE

DIODES INCORPORATED MAKES NO WARRANTY OF ANY KIND, EXPRESS OR IMPLIED, WITH REGARDS TO THIS DOCUMENT, INCLUDING, BUT NOT LIMITED TO, THE IMPLIED WARRANTIES OF MERCHANTABILITY AND FITNESS FOR A PARTICULAR PURPOSE (AND THEIR EQUIVALENTS UNDER THE LAWS OF ANY JURISDICTION).

Diodes Incorporated and its subsidiaries reserve the right to make modifications, enhancements, improvements, corrections or other changes without further notice to this document and any product described herein. Diodes Incorporated does not assume any liability arising out of the application or use of this document or any product described herein; neither does Diodes Incorporated convey any license under its patent or trademark rights, nor the rights of others. Any Customer or user of this document or products described herein in such applications shall assume all risks of such use and will agree to hold Diodes Incorporated and all the companies whose products are represented on Diodes Incorporated website, harmless against all damages.

Diodes Incorporated does not warrant or accept any liability whatsoever in respect of any products purchased through unauthorized sales channel. Should Customers purchase or use Diodes Incorporated products for any unintended or unauthorized application, Customers shall indemnify and hold Diodes Incorporated and its representatives harmless against all claims, damages, expenses, and attorney fees arising out of, directly or indirectly, any claim of personal injury or death associated with such unintended or unauthorized application.

Products described herein may be covered by one or more United States, international or foreign patents pending. Product names and markings noted herein may also be covered by one or more United States, international or foreign trademarks.

This document is written in English but may be translated into multiple languages for reference. Only the English version of this document is the final and determinative format released by Diodes Incorporated.

LIFE SUPPORT

Diodes Incorporated products are specifically not authorized for use as critical components in life support devices or systems without the express written approval of the Chief Executive Officer of Diodes Incorporated. As used herein:

A. Life support devices or systems are devices or systems which:

1. are intended to implant into the body, or
2. support or sustain life and whose failure to perform when properly used in accordance with instructions for use provided in the labeling can be reasonably expected to result in significant injury to the user.

B. A critical component is any component in a life support device or system whose failure to perform can be reasonably expected to cause the failure of the life support device or to affect its safety or effectiveness.

Customers represent that they have all necessary expertise in the safety and regulatory ramifications of their life support devices or systems, and acknowledge and agree that they are solely responsible for all legal, regulatory and safety-related requirements concerning their products and any use of Diodes Incorporated products in such safety-critical, life support devices or systems, notwithstanding any devices- or systems-related information or support that may be provided by Diodes Incorporated. Further, Customers must fully indemnify Diodes Incorporated and its representatives against any damages arising out of the use of Diodes Incorporated products in such safety-critical, life support devices or systems.

Copyright © 2016, Diodes Incorporated

www.diodes.com

Looking for pricing, stock, or lifecycle information?

Click below to explore more details on WIN SOURCE:

 [View AL5809-20S1-7 on WIN SOURCE](#)

 [Diodes Incorporated](#) Information

Optimize Your Supply Chain with WIN SOURCE Solutions

-  Global Sourcing Solution
-  Obsolete Management
-  Cost Control Management
-  Shortage Management
-  Alternative Solution
-  Excess Inventory Management