

# BAP1321-02

Silicon PIN diode

Rev. 02 — 3 January 2008

Product data sheet

## IMPORTANT NOTICE

Dear customer,

As from October 1st, 2006 Philips Semiconductors has a new trade name - NXP Semiconductors, which will be used in future data sheets together with new contact details.

In data sheets where the previous Philips references remain, please use the new links as shown below.

<http://www.philips.semiconductors.com> use <http://www.nxp.com>

<http://www.semiconductors.philips.com> use <http://www.nxp.com> (Internet)

[sales.addresses@www.semiconductors.philips.com](mailto:sales.addresses@www.semiconductors.philips.com) use [salesaddresses@nxp.com](mailto:salesaddresses@nxp.com) (email)

The copyright notice at the bottom of each page (or elsewhere in the document, depending on the version)

- © Koninklijke Philips Electronics N.V. (year). All rights reserved -

is replaced with:

- © NXP B.V. (year). All rights reserved. -

If you have any questions related to the data sheet, please contact our nearest sales office via e-mail or phone (details via [salesaddresses@nxp.com](mailto:salesaddresses@nxp.com)). Thank you for your cooperation and understanding,

NXP Semiconductors

# Silicon PIN diode

# BAP1321-02

### FEATURES

- High voltage, current controlled
- RF resistor for RF attenuators and switches
- Low diode capacitance
- Low diode forward resistance
- Very low series inductance
- For applications up to 3 GHz.

### APPLICATIONS

- RF attenuators and switches.

### DESCRIPTION

Planar PIN diode in a SOD523 ultra small SMD plastic package.

### PINNING

PIN	DESCRIPTION
1	cathode
2	anode

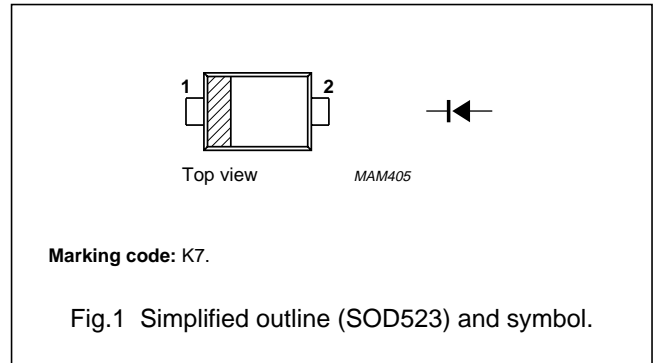

### LIMITING VALUES

In accordance with the Absolute Maximum Rating System (IEC 60134).

SYMBOL	PARAMETER	CONDITIONS	MIN.	MAX.	UNIT
$V_R$	continuous reverse voltage		–	60	V
$I_F$	continuous forward current		–	100	mA
$P_{tot}$	total power dissipation	$T_s \leq 90\text{ °C}$	–	715	mW
$T_{stg}$	storage temperature		–65	+150	°C
$T_j$	junction temperature		–65	+150	°C

## Silicon PIN diode

## BAP1321-02

**ELECTRICAL CHARACTERISTICS**T<sub>j</sub> = 25 °C unless otherwise specified.

SYMBOL	PARAMETER	CONDITIONS	TYP.	MAX.	UNIT
V <sub>F</sub>	forward voltage	I <sub>F</sub> = 50 mA	0.95	1.1	V
I <sub>R</sub>	reverse leakage current	V <sub>R</sub> = 60 V	–	100	nA
C <sub>d</sub>	diode capacitance	V <sub>R</sub> = 0; f = 1 MHz	0.4	–	pF
		V <sub>R</sub> = 1 V; f = 1 MHz	0.35	0.45	pF
		V <sub>R</sub> = 20 V; f = 1 MHz	0.25	0.32	pF
r <sub>D</sub>	diode forward resistance	f = 100 MHz; note 1			
		I <sub>F</sub> = 0.5 mA	3.4	5.0	Ω
		I <sub>F</sub> = 1 mA	2.4	3.6	Ω
		I <sub>F</sub> = 10 mA	1.2	1.8	Ω
S <sub>21</sub>   <sup>2</sup>	isolation	V <sub>R</sub> = 0; f = 900 MHz	16.3	–	dB
		V <sub>R</sub> = 0; f = 1800 MHz	11.4	–	dB
		V <sub>R</sub> = 0; f = 2450 MHz	9.2	–	dB
		I <sub>F</sub> = 0.5 mA; f = 900 MHz	0.23	–	dB
S <sub>21</sub>   <sup>2</sup>	insertion loss	I <sub>F</sub> = 0.5 mA; f = 1800 MHz	0.27	–	dB
		I <sub>F</sub> = 0.5 mA; f = 2450 MHz	0.33	–	dB
		I <sub>F</sub> = 1 mA; f = 900 MHz	0.18	–	dB
S <sub>21</sub>   <sup>2</sup>	insertion loss	I <sub>F</sub> = 1 mA; f = 1800 MHz	0.22	–	dB
		I <sub>F</sub> = 1 mA; f = 2450 MHz	0.27	–	dB
		I <sub>F</sub> = 10 mA; f = 900 MHz	0.10	–	dB
S <sub>21</sub>   <sup>2</sup>	insertion loss	I <sub>F</sub> = 10 mA; f = 1800 MHz	0.16	–	dB
		I <sub>F</sub> = 10 mA; f = 2450 MHz	0.20	–	dB
		I <sub>F</sub> = 100 mA; f = 900 MHz	0.08	–	dB
S <sub>21</sub>   <sup>2</sup>	insertion loss	I <sub>F</sub> = 100 mA; f = 1800 MHz	0.13	–	dB
		I <sub>F</sub> = 100 mA; f = 2450 MHz	0.18	–	dB
τ <sub>L</sub>	charge carrier life time	when switched from I <sub>F</sub> = 10 mA to I <sub>R</sub> = 6 mA; R <sub>L</sub> = 100 Ω; measured at I <sub>R</sub> = 3 mA	0.5	–	μs
L <sub>S</sub>	series inductance	I <sub>F</sub> = 100 mA; f = 100 MHz	0.6	–	nH

**Note**

1. Guaranteed on AQL basis: inspection level S4, AQL 1.0.

**THERMAL CHARACTERISTICS**

SYMBOL	PARAMETER	VALUE	UNIT
R <sub>th j-s</sub>	thermal resistance from junction to soldering point	85	K/W

Silicon PIN diode

BAP1321-02

GRAPHICAL DATA

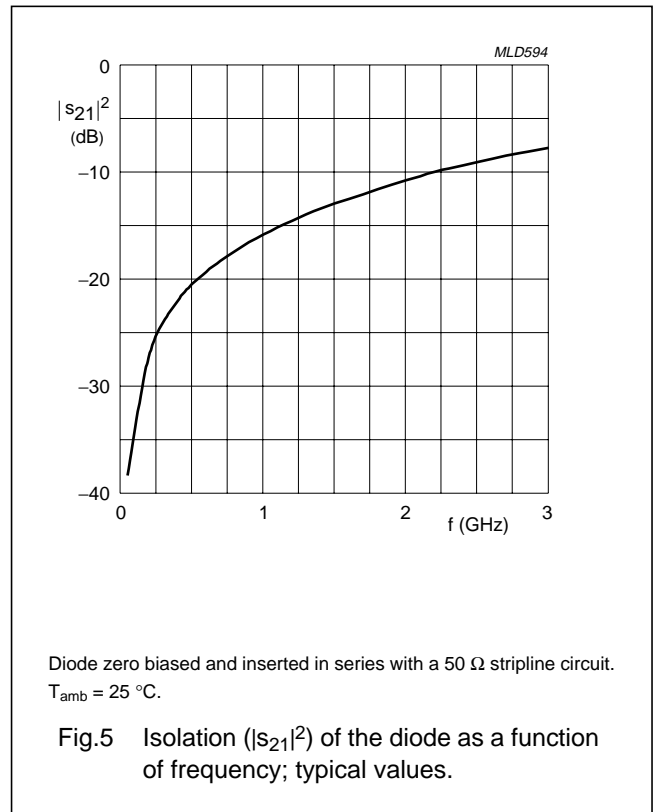
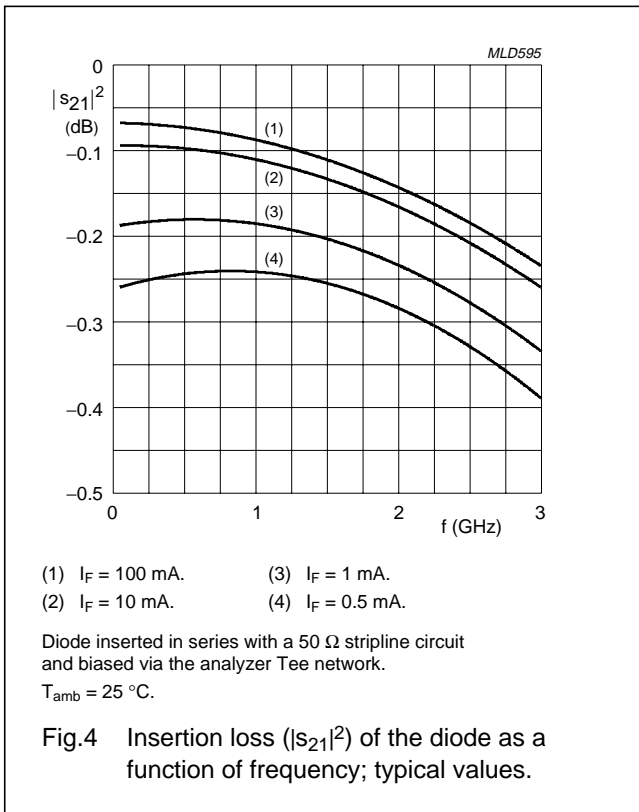
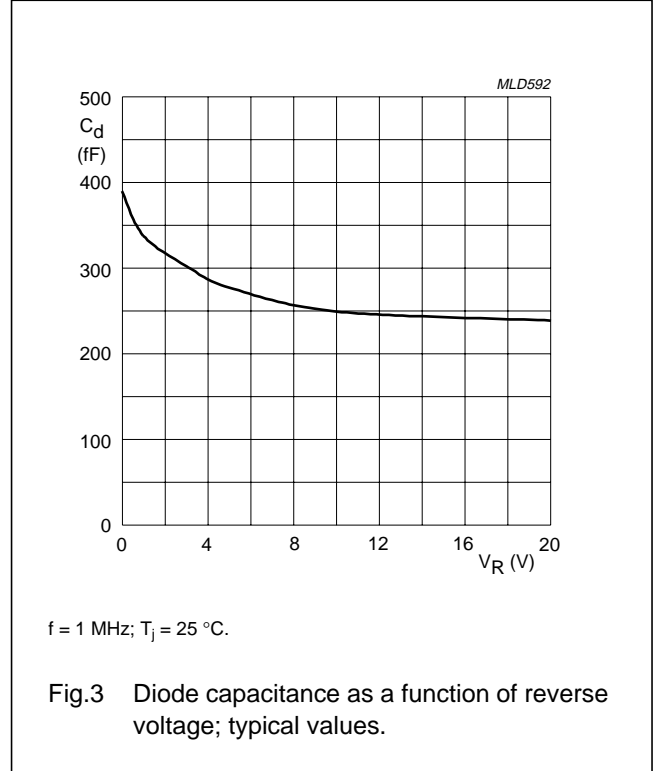
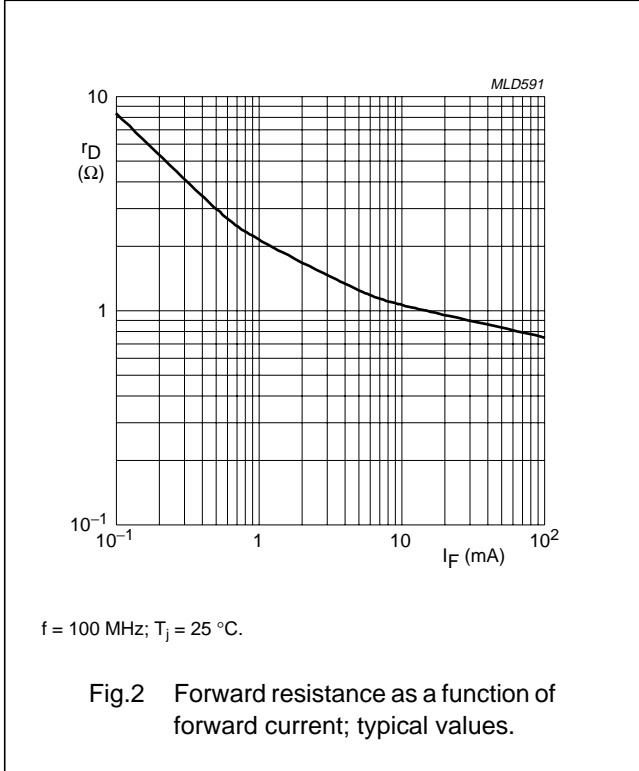

Silicon PIN diode

BAP1321-02

PACKAGE OUTLINE

Plastic surface-mounted package; 2 leads

SOD523

**DIMENSIONS (mm are the original dimensions)**

UNIT	A	bp	c	D	E	HE	v
mm	0.65 0.58	0.34 0.26	0.17 0.11	1.25 1.15	0.85 0.75	1.65 1.55	0.1

**Note**  
1. The marking bar indicates the cathode.

OUTLINE VERSION	REFERENCES				EUROPEAN PROJECTION	ISSUE DATE
	IEC	JEDEC	JEITA			
SOD523			SC-79			02-12-13 06-03-16

## Legal information

### Data sheet status

Document status <sup>[1][2]</sup>	Product status <sup>[3]</sup>	Definition
Objective [short] data sheet	Development	This document contains data from the objective specification for product development.
Preliminary [short] data sheet	Qualification	This document contains data from the preliminary specification.
Product [short] data sheet	Production	This document contains the product specification.

[1] Please consult the most recently issued document before initiating or completing a design.

[2] The term 'short data sheet' is explained in section "Definitions".

[3] The product status of device(s) described in this document may have changed since this document was published and may differ in case of multiple devices. The latest product status information is available on the Internet at URL <http://www.nxp.com>.

### Definitions

**Draft** — The document is a draft version only. The content is still under internal review and subject to formal approval, which may result in modifications or additions. NXP Semiconductors does not give any representations or warranties as to the accuracy or completeness of information included herein and shall have no liability for the consequences of use of such information.

**Short data sheet** — A short data sheet is an extract from a full data sheet with the same product type number(s) and title. A short data sheet is intended for quick reference only and should not be relied upon to contain detailed and full information. For detailed and full information see the relevant full data sheet, which is available on request via the local NXP Semiconductors sales office. In case of any inconsistency or conflict with the short data sheet, the full data sheet shall prevail.

### Disclaimers

**General** — Information in this document is believed to be accurate and reliable. However, NXP Semiconductors does not give any representations or warranties, expressed or implied, as to the accuracy or completeness of such information and shall have no liability for the consequences of use of such information.

**Right to make changes** — NXP Semiconductors reserves the right to make changes to information published in this document, including without limitation specifications and product descriptions, at any time and without notice. This document supersedes and replaces all information supplied prior to the publication hereof.

**Suitability for use** — NXP Semiconductors products are not designed, authorized or warranted to be suitable for use in medical, military, aircraft, space or life support equipment, nor in applications where failure or

malfunction of an NXP Semiconductors product can reasonably be expected to result in personal injury, death or severe property or environmental damage. NXP Semiconductors accepts no liability for inclusion and/or use of NXP Semiconductors products in such equipment or applications and therefore such inclusion and/or use is at the customer's own risk.

**Applications** — Applications that are described herein for any of these products are for illustrative purposes only. NXP Semiconductors makes no representation or warranty that such applications will be suitable for the specified use without further testing or modification.

**Limiting values** — Stress above one or more limiting values (as defined in the Absolute Maximum Ratings System of IEC 60134) may cause permanent damage to the device. Limiting values are stress ratings only and operation of the device at these or any other conditions above those given in the Characteristics sections of this document is not implied. Exposure to limiting values for extended periods may affect device reliability.

**Terms and conditions of sale** — NXP Semiconductors products are sold subject to the general terms and conditions of commercial sale, as published at <http://www.nxp.com/profile/terms>, including those pertaining to warranty, intellectual property rights infringement and limitation of liability, unless explicitly otherwise agreed to in writing by NXP Semiconductors. In case of any inconsistency or conflict between information in this document and such terms and conditions, the latter will prevail.

**No offer to sell or license** — Nothing in this document may be interpreted or construed as an offer to sell products that is open for acceptance or the grant, conveyance or implication of any license under any copyrights, patents or other industrial or intellectual property rights.

### Trademarks

Notice: All referenced brands, product names, service names and trademarks are the property of their respective owners.

## Contact information

For additional information, please visit: <http://www.nxp.com>

For sales office addresses, send an email to: [salesaddresses@nxp.com](mailto:salesaddresses@nxp.com)

## Revision history

### Revision history

Document ID	Release date	Data sheet status	Change notice	Supersedes
BAP1321-02_N_2	20080103	Product data sheet	-	BAP1321-02_1
Modifications:	• Package outline drawing on page 5 changed			
BAP1321-02_1 (9397 750 08131)	20010417	Product specification	-	-

Please be aware that important notices concerning this document and the product(s) described herein, have been included in section 'Legal information'.

founded by

**PHILIPS**

© NXP B.V. 2008.

All rights reserved.

For more information, please visit: <http://www.nxp.com>



For sales office addresses, please send an email to: [salesaddresses@nxp.com](mailto:salesaddresses@nxp.com)

Date of release: 3 January 2008

Document identifier: BAP1321-02\_N\_2

## Looking for pricing, stock, or lifecycle information?

Click below to explore more details on WIN SOURCE:

-  [View BAP1321-02,115 on WIN SOURCE](#)
-  [NXP / Nexperia Information](#)

## Optimize Your Supply Chain with WIN SOURCE Solutions

-  Global Sourcing Solution
-  Obsolete Management
-  Cost Control Management
-  Shortage Management
-  Alternative Solution
-  Excess Inventory Management