



**THE DATASHEET OF
FH34S-14S-0.5SH(50)**



0.5 mm Pitch, 1.0 mm above the board Top and Top/Bottom Contact, Back-Flip actuator Flexible Printed Circuit & Flexible Flat Cable ZIF Connectors

FH34(S)Series

Increased FPC/FFC holding force

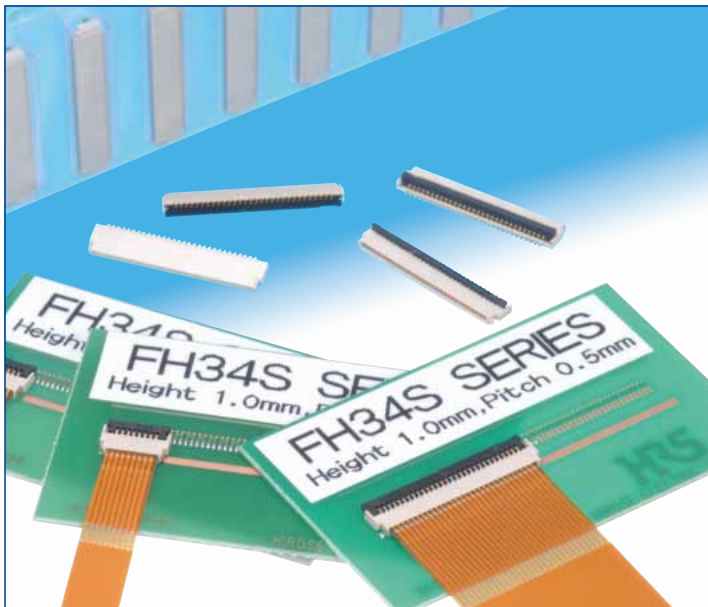

Space saving (30 pos. shown)

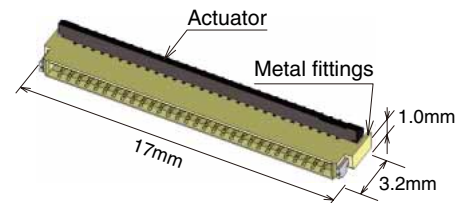

Easy FPC/FFC insertion

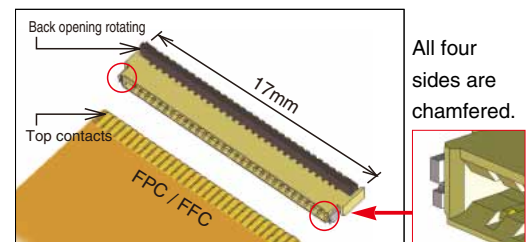

Ready to insert FPC/FFC

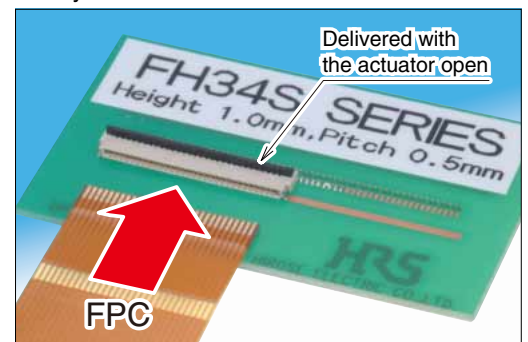

FPC/FFC inserted and retained.
Completed electrical and mechanical connection.

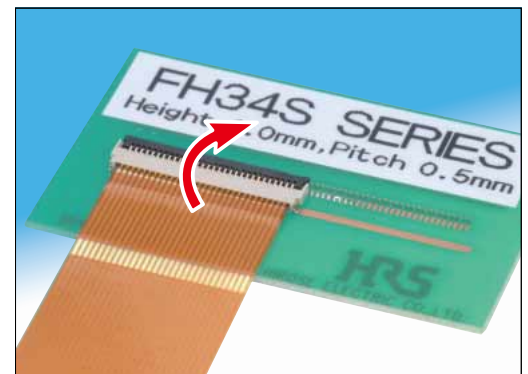

Compatible with existing connectors.(FH19SC SERIES)



Features

1. Low-profile

With the 1.0 mm above the board and width of 3.8 mm the connectors are used in space saving applications.

2. Increased FPC/FFC retention

As compared with existing similar construction connectors:

- * In horizontal direction: Approximately 2.6 times
- * In vertical direction: Approximately 2 times

3. Unique Back-Flip rotating actuator

The rotating actuator opens from the back of the connector, assuring reliable electrical and mechanical connection.

4. Easy FPC insertion and reliable electrical connection

Proven Flip Lock actuator allows easy insertion of FPC and provides a tactile sensation when fully closed, confirming complete electrical and mechanical connection.

5. Delivered with the actuator open

FPC/FFC can be immediately inserted without the need for the opening of the actuator.

6. Accepts standard FPC thickness

0.3mm thick standard Flexible Printed Circuit (FPC) can be used. This is the only ultra-low profile ZIF connector using standard FPC.

7. Compatible with existing connectors.

FPC/FFC and PCB mounting patterns are the same as for the FH19SC Series (bottom contact), allowing the use of both connectors for interconnections between two boards or replacement of the connectors.

8. Conductive traces on the PCB can run under the connector

No exposed contacts on the bottom of the connector.

9. Board placement with automatic equipment

Flat upper surface and tape and reel packaging facilitate vacuum pick-up and placement.

Standard reel packaging contains 5000 connectors.

10. Halogen-free*

*As defined by IEC61249-2-21

Br-900ppm maximum, Cl-900ppm maximum, Cl + Br combined-1,500ppm maximum

Specifications

Ratings	Current rating 0.5 A (Note 1)	Operating temperature range: -55 to +85°C (Note 1)	Storage temperature range: -10 to +50°C (Note 2)
	Voltage rating 50 Vrms AC	Operating humidity range: Relative humidity 90% max. (No condensation)	Storage humidity range: Relative humidity 90% max. (No condensation)

Recommended FPC/FFC	Thickness: 0.3 ± 0.03 mm, Gold plated contact pads
---------------------	--

Item	Specification	Conditions
1. Insulation resistance	500 MΩ min.	100 V DC
2. Withstanding voltage	No flashover or insulation breakdown	250 Vrms AC / one minute
3. Contact resistance	100 mΩ max. * Including FPC and FFC conductor resistance	1 mA, AC / DC 20mV max (AC: 1kHz)
4. Durability	Contact resistance: 100 mΩ max. No damage, cracks, or parts dislocation	20 cycles
5. Vibration	No electrical discontinuity of 1μs or longer Contact resistance: 100 mΩ max. No damage, cracks, or parts dislocation	Frequency: 10 to 55 Hz, single amplitude of 0.75 mm, 10 cycles in each of the 3 axis
6. Shock	No electrical discontinuity of 1μs or longer Contact resistance: 100 mΩ max. No damage, cracks, or parts dislocation	Acceleration of 981m/s ² , 6 ms duration, sine half-wave, 3 cycles in each of the 3 axis
7. Humidity (Steady state)	Contact resistance: 100 mΩ max. Insulation resistance: 50 MΩ min. No damage, cracks, or parts dislocation	96 hours at 40°C and humidity of 90 to 95%
8. Temperature cycle	Contact resistance: 100 mΩ max. Insulation resistance: 50 MΩ min. No damage, cracks, or parts dislocation	Temperature : -55°C → +15°C to +35°C → +85°C → +15°C to +35°C Time: 30 → 2 to 3 → 30 → 2 to 3 minutes 5 cycles
9. Resistance to soldering heat	No deformation of components affecting performance	Reflow: At the recommended temperature profile Manual soldering: 350°C ±5°C for 5 seconds (Note 3)

Note1: When passing the current through all of the contacts, use 70% of the rated current.

Note2: Includes temperature rise caused by current flow.

Note3: The term "storage" refers to products stored for a long period prior to mounting and use.

The operating temperature and humidity range covers the non-conducting condition of installed connectors in storage, shipment or during transportation after board mounting.

Materials

Part	Material	Finish		Remarks
Insulator	LCP	FH34S series	Color:Beige	UL94V-0
		FH34SRJ series	Color:Gray	
	PA	FH34S series	Color:Black	
		FH34SRJ series		
	LCP(8pos.)	FH34SRJ series	Color:Black	UL94V-0
Contacts	Phosphor bronze	Gold plating with nickel barrier		—
Metalfittings	Phosphor bronze	Pure tin reflow plating		—

Ordering information

FH 34S RJ - 30S - 0.5 SH (50)

① ② ③ ④ ⑤ ⑥ ⑦

① Series name : FH	⑥ Termination type SH : SMT horizontal mounting type
② Series No. : 34S	
③ Blank : Top contact RJ : Top and Bottom contact, halogen-free (Flame retardance UL94V-0).	⑦ Specifications (50)...Standard product 5,000 pieces/reel (99)...500 pieces/reel
④ Number of positions : 4 to 40	
⑤ Contact pitch : 0.5mm	

Connector Dimensions

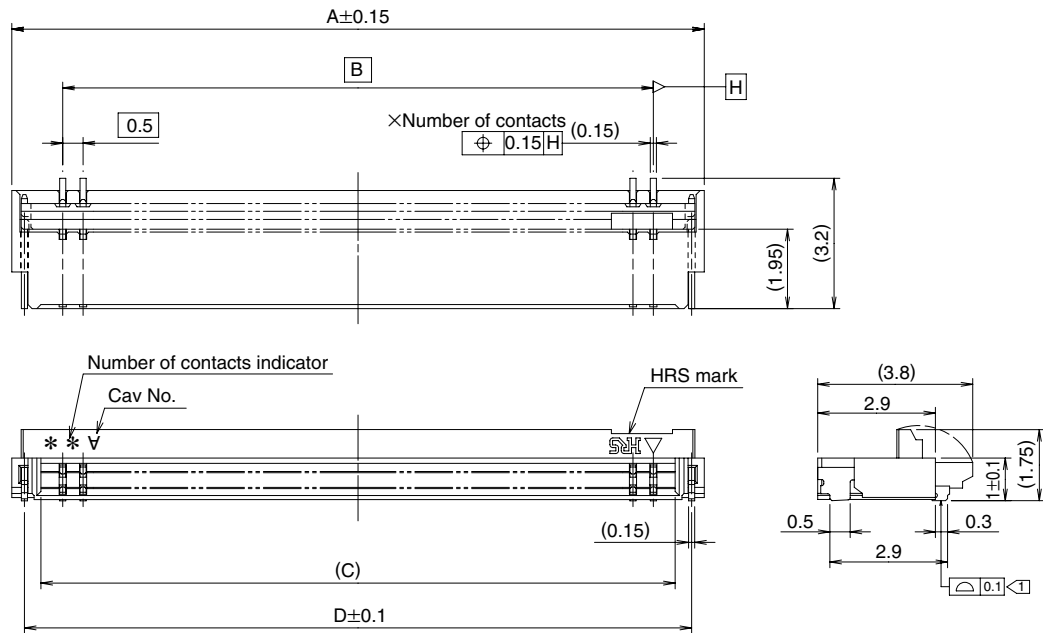

Note 1: The coplanarity of each terminal lead within specified dimension is 0.1 mm Max.

Note 2: Packaged on tape and reel only. Check packaging specification.

Note 3: Slight variations in color of the plastic compounds do not affect form, fit or function of the connector.

Note 4: After reflow, the terminal plating may change color, however this does not represent a quality issue.

All dimensions: mm

Part Number	CL No.	Number of Contacts	A	B	C	D
FH34S-7S-0.5SH(50)	CL580-1224-2-50	7	5.5	3	4.03	4.88
FH34S-23S-0.5SH(50)	CL580-1228-3-50	23	13.5	11	12.07	12.88
FH34S-32S-0.5SH(50)	CL580-1208-6-50	32	18	15.5	16.53	17.38
FH34SRJ-4S-0.5SH(50)	CL580-1238-7-50	4	4	1.5	2.53	3.38
FH34SRJ-6S-0.5SH(50)	CL580-1236-1-50	6	5	2.5	3.53	4.38
FH34SRJ-8S-0.5SH(50)	CL580-1231-8-50	8	6	3.5	4.53	5.38
FH34SRJ-10S-0.5SH(50)	CL580-1251-5-50	10	7	4.5	5.53	6.38
FH34SRJ-11S-0.5SH(50)	CL580-1258-4-50	11	7.5	5	6.03	6.88
FH34SRJ-12S-0.5SH(50)	CL580-1253-0-50	12	8	5.5	6.53	7.38
FH34SRJ-14S-0.5SH(50)	CL580-1252-8-50	14	9	6.5	7.53	8.38
FH34SRJ-16S-0.5SH(50)	CL580-1259-7-50	16	10	7.5	8.57	9.38
FH34SRJ-18S-0.5SH(50)	CL580-1248-0-50	18	11	8.5	9.57	10.38
FH34SRJ-20S-0.5SH(50)	CL580-1256-9-50	20	12	9.5	10.57	11.38
FH34SRJ-22S-0.5SH(50)	CL580-1254-3-50	22	13	10.5	11.57	12.38
FH34SRJ-24S-0.5SH(50)	CL580-1255-6-50	24	14	11.5	12.57	13.38
FH34SRJ-26S-0.5SH(50)	CL580-1247-8-50	26	15	12.5	13.57	14.38
FH34SRJ-30S-0.5SH(50)	CL580-1232-0-50	30	17	14.5	15.57	16.38
FH34SRJ-34S-0.5SH(50)	CL580-1261-9-50	34	19	16.5	17.53	18.38
FH34SRJ-40S-0.5SH(50)	CL580-1260-9-50	40	22	19.5	20.53	21.38

Tape and reel packaging (5,000 pieces/reel, 500 pieces/reel).

Order by number of reels.

Recommended PCB mounting pattern and metal mask dimensions

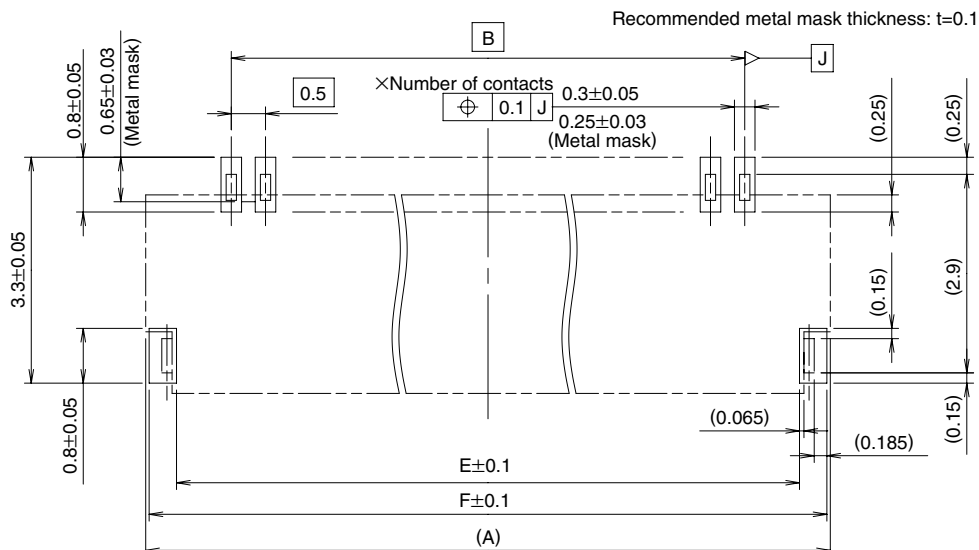

Recommended FPC/FFC Dimensions

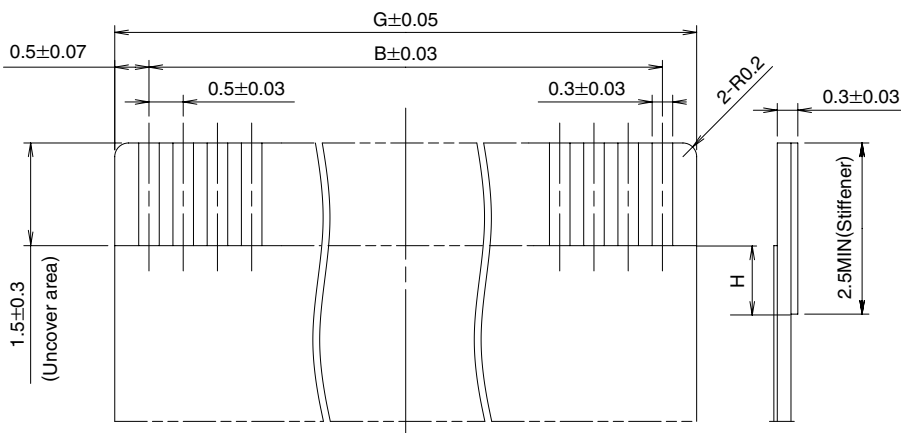

Note 1 : Stiffener dimension should be 2.5mm min., and H dimension should be 0.5mm for improved flexibility of FPC.

Note 2 : When using the FPC/FFC in FH34S or FH19SC connectors, the exposed area inserted in either connector is 2.5mm ± 0.3mm and the stiffener is 3.5mm min.

All dimensions: mm

Part Number	CL No.	Number of Contacts	A	B	E	F	G
FH34S-7S-0.5SH(50)	CL580-1224-2-50	7	5.5	3	4.6	5.4	4
FH34S-23S-0.5SH(50)	CL580-1228-3-50	23	13.5	11	12.6	13.4	12
FH34S-32S-0.5SH(50)	CL580-1208-6-50	32	18	15.5	17.1	17.9	16.5
FH34SRJ-4S-0.5SH(50)	CL580-1238-7-50	4	4	1.5	3.1	3.9	2.5
FH34SRJ-6S-0.5SH(50)	CL580-1236-1-50	6	5	2.5	4.1	4.9	3.5
FH34SRJ-8S-0.5SH(50)	CL580-1231-8-50	8	6	3.5	5.1	5.9	4.5
FH34SRJ-10S-0.5SH(50)	CL580-1251-5-50	10	7	4.5	6.1	6.9	5.5
FH34SRJ-11S-0.5SH(50)	CL580-1258-4-50	11	7.5	5	6.6	7.4	6
FH34SRJ-12S-0.5SH(50)	CL580-1253-0-50	12	8	5.5	7.1	7.9	6.5
FH34SRJ-14S-0.5SH(50)	CL580-1252-8-50	14	9	6.5	8.1	8.9	7.5
FH34SRJ-16S-0.5SH(50)	CL580-1259-7-50	16	10	7.5	9.1	9.9	8.5
FH34SRJ-18S-0.5SH(50)	CL580-1248-0-50	18	11	8.5	10.1	10.9	9.5
FH34SRJ-20S-0.5SH(50)	CL580-1256-9-50	20	12	9.5	11.1	11.9	10.5
FH34SRJ-22S-0.5SH(50)	CL580-1254-3-50	22	13	10.5	12.1	12.9	11.5
FH34SRJ-24S-0.5SH(50)	CL580-1255-6-50	24	14	11.5	13.1	13.9	12.5
FH34SRJ-26S-0.5SH(50)	CL580-1247-8-50	26	15	12.5	14.1	14.9	13.5
FH34SRJ-30S-0.5SH(50)	CL580-1232-0-50	30	17	14.5	16.1	16.9	15.5
FH34SRJ-34S-0.5SH(50)	CL580-1261-9-50	34	19	16.5	18.1	18.9	17.5
FH34SRJ-40S-0.5SH(50)	CL580-1260-9-50	40	22	19.5	21.1	21.9	20.5

Recommended FPC construction

● Contact FPC manufacturer for specific details.

1. Using Single-sided FPC

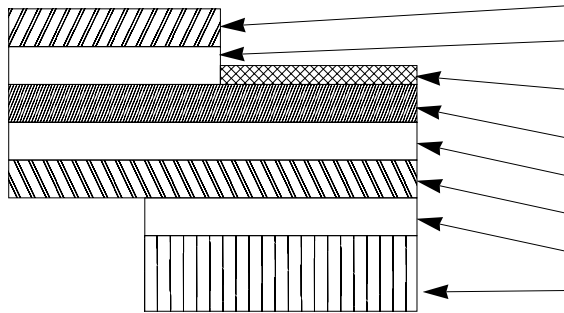

FPC : Flexible Printed Circuit

Material Name	Material	Material Thickness (μm)
Covering film layer	Polyimide 1 mil thick	(25)
Cover adhesive		(25)
Surface treatment	0.2μm thick gold plated over 1 to 5μm thick nickel underplating	3
Copper foil	Cu 1oz	35
Base adhesive	Thermosetting adhesive	25
Base film	Polyimide 1 mil thick	25
Reinforcement material adhesive	Thermosetting adhesive	35
Stiffener	Polyimide 7 mil thick	175
Total		298

2. Using Double-sided FPC

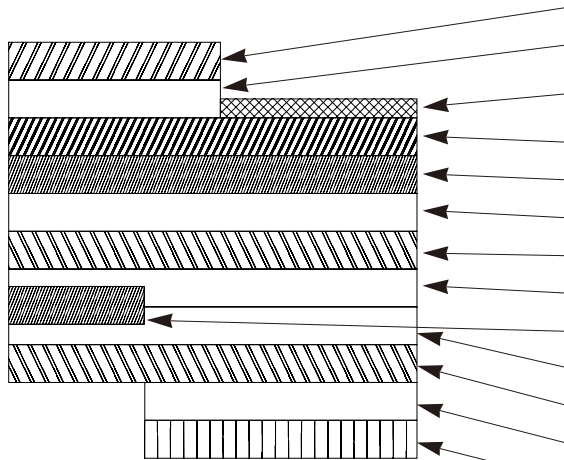

FPC : Flexible Printed Circuit

Material Name	Material	Material Thickness (μm)
Covering layer film	Polyimide 1 mil thick	(25)
Cover adhesive		(25)
Surface treatment	0.2μm thick gold plated over 1 to 5μm thick nickel underplating	3
Through-hole copper	Cu	15
Copper foil	Cu 1/2oz	18
Base adhesive	Thermosetting adhesive	18
Base film	Polyimide 1 mil thick	25
Base adhesive		18
Copper foil	Cu 1/2oz	(18)
Cover adhesive	Thermosetting adhesive	25
Covering film layer	Polyimide 1 mil thick	25
Reinforcement material adhesive	Thermosetting adhesive	50
Stiffener	Polyimide 4 mil thick	100
Total		297

* To prevent release of the FPC due to its bending, use of the double sided FPC with copper foil on the back side is not recommended.

3. Using FFC

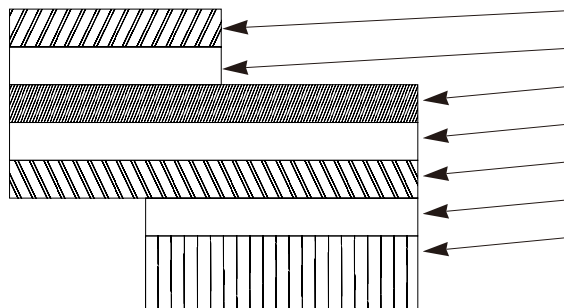

FFC : Flexible Flat Cable

Material Name	Material	Material Thickness (μm)
Polyester film		(12)
Adhesive	Thermoplastic polyester	(30)
Gold plated annealed copper foil		35
Adhesive	Polyester	30
Polyester		12
Adhesive	Polyester	30
Stiffener	Polyester	188
Total		295

4. Precautions

1. This specification is a recommendation for the construction of the FH34S Series FPC and FFC (t=0.3 ± 0.03).
2. For details about the construction, please contact the FPC/FFC manufacturers.

Packaging Specification

● Embossed Carrier Tape Dimensions (Tape width 24mm max.)

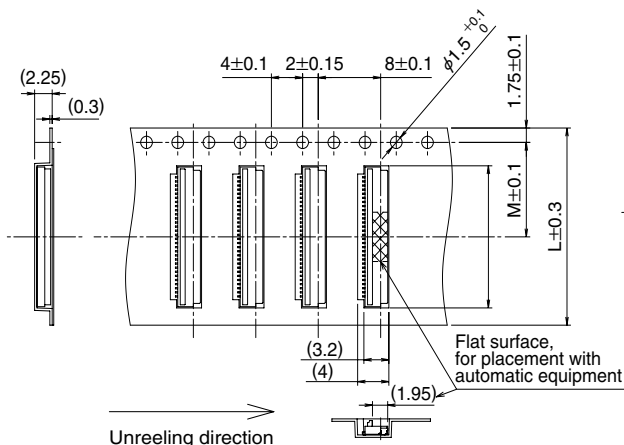

● Embossed Carrier Tape Dimensions (Tape width of 32mm min.)

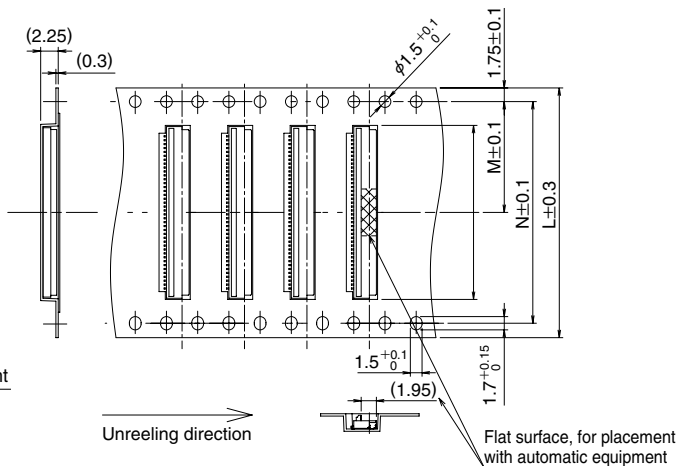

● Reel Dimensions

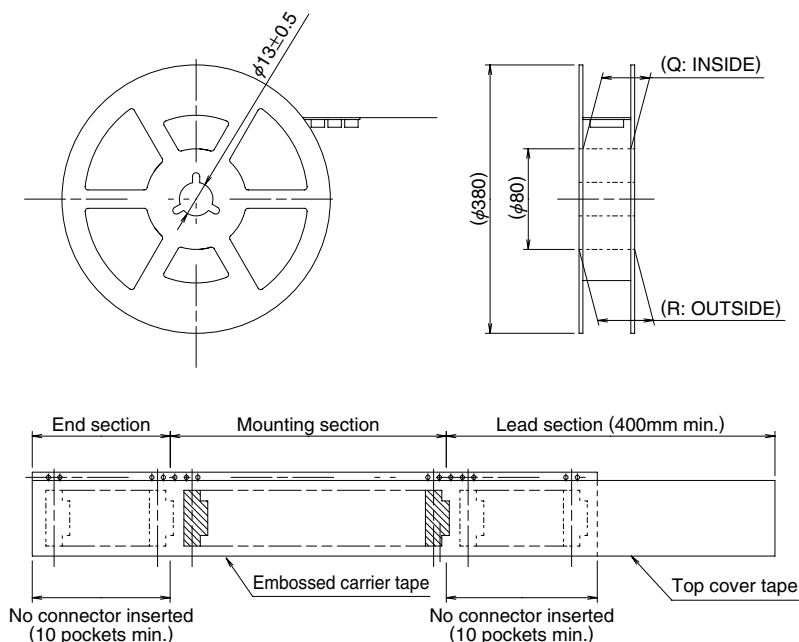



All dimensions: mm

Part Number	CL No.	Number of Contacts	L	M	N	Q	R
FH34S-7S-0.5SH(50)	CL580-1224-2-50	7	16	7.5	—	17.4	21.4
FH34S-23S-0.5SH(50)	CL580-1228-3-50	23	24	11.5	—	25.4	29.4
FH34S-32S-0.5SH(50)	CL580-1208-6-50	32	32	14.2	28.4	33.4	37.4
FH34SRJ-4S-0.5SH(50)	CL580-1238-7-50	4	16	7.5	—	17.4	21.4
FH34SRJ-6S-0.5SH(50)	CL580-1236-1-50	6	16	7.5	—	17.4	21.4
FH34SRJ-8S-0.5SH(50)	CL580-1231-8-50	8	16	7.5	—	17.4	21.4
FH34SRJ-10S-0.5SH(50)	CL580-1251-5-50	10	16	7.5	-	17.4	21.4
FH34SRJ-11S-0.5SH(50)	CL580-1258-4-50	11	16	7.5	-	17.4	21.4
FH34SRJ-12S-0.5SH(50)	CL580-1253-0-50	12	24	11.5	-	25.4	29.4
FH34SRJ-14S-0.5SH(50)	CL580-1252-8-50	14	24	11.5	-	25.4	29.4
FH34SRJ-16S-0.5SH(50)	CL580-1259-7-50	16	24	11.5	-	25.4	29.4
FH34SRJ-18S-0.5SH(50)	CL580-1248-0-50	18	24	11.5	-	25.4	29.4
FH34SRJ-20S-0.5SH(50)	CL580-1256-9-50	20	24	11.5	-	25.4	29.4
FH34SRJ-22S-0.5SH(50)	CL580-1254-3-50	22	24	11.5	-	25.4	29.4
FH34SRJ-24S-0.5SH(50)	CL580-1255-6-50	24	24	11.5	-	25.4	29.4
FH34SRJ-26S-0.5SH(50)	CL580-1247-8-50	26	24	11.5	-	25.4	29.4
FH34SRJ-30S-0.5SH(50)	CL580-1232-0-50	30	32	14.2	28.4	33.4	37.4
FH34SRJ-34S-0.5SH(50)	CL580-1261-9-50	34	32	14.2	28.4	33.4	37.4
FH34SRJ-40S-0.5SH(50)	CL580-1260-9-50	40	44	20.2	40.4	45.4	49.4

■ Operation and Precautions

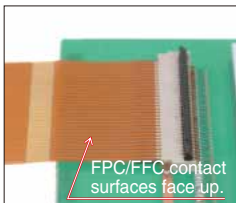
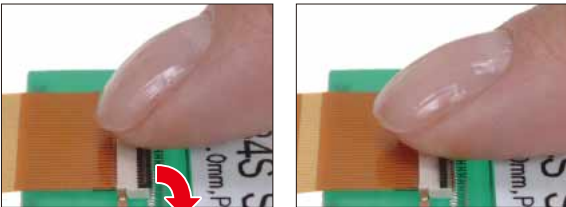
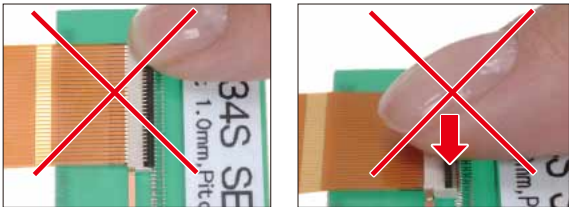
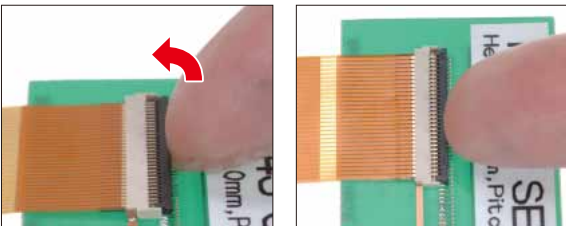
Exercise care when handling connectors. Follow recommendations given below.

Operation	Precautions
<p>1. As delivered</p> <p>Delivered with the actuator open. There is no need to operate the actuator prior to inserting the FPC/FFC.</p> 	<ul style="list-style-type: none"> Do not close the actuator without the FPC/FFC inserted.
<p>2. FPC/FFC insertion (The top contact specification)</p> <p>Insert the FPC/FFC with the conductive surfaces facing up. Align the FPC/FFC straight with the connector and insert it firmly all the way.</p> 	<ul style="list-style-type: none"> The contacts are making connection with the FPC/FFC pads from the top. Do not insert the FPC/FFC with the pads facing down. When inserting the FPC/FFC do not twist it. Insert straight. Improper insertion may cause deformation of the contacts and connection failures. Be sure to insert the FPC/FFC when the actuator is fully open.
<p>3. Locking</p> <p>After FPC/FFC insertion, rotate the actuator down to a full stop, pushing it at the center.</p> 	<ul style="list-style-type: none"> Do not operate the actuator by only one end. Open or close by pushing at the center. Do not try to rotate the actuator past the fully open 90° position. This will damage the connector, preventing it from use. Do not apply excessive force to the connector when the actuator is closed. 
<p>4. FPC/FFC removal (Lock release)</p> <p>Carefully rotate the actuator up to 90°, lifting it at the center.</p> 	<ul style="list-style-type: none"> Do not operate the actuator from one end only. The actuator opens only 90°. Do not attempt to open it past this angle or grasp it. During the opening of the actuator do not press it toward the connector body. Rotate up at the center. 

■Precautions at the Design Stage

- (1) Route the FPC/FFC so that a direct pull force
- (2) Make sure that there is enough space to insert/remove the FPC/FFC straight.
- (3) Follow the recommendations given in this catalog in regard to mounting pattern, metal mask dimensions and FPC/FFC mating dimensions.
- (4) Consult the manufacturer of the FPC/FFC for the details on the flexibility of the specific FPC/FFC.
- (5) When designing the board lay-out and spaces in the device assure that there is enough clearances for the actuator to fully open/close.

■Precautions when mounting connectors on the PCB

◆Handling before mounting on PCB

Insertion of the FPC/FFC or operation of the actuator prior to mounting on the PCB is not recommended.

◆PC board warpage

Minimize the warpage as much as possible. The connector are straight within 0.1 mm max. Make sure that the mounting area flatness can accept the connector terminals without causing any failure of the solder joints.

◆Forces on the board

◆When braking the large PC board into individual boards exercise care not to damage the installed connectors.

◆When attaching the boards or other components with the screws make sure that any stresses will not cause board deflections affecting the mounting areas of the connector.

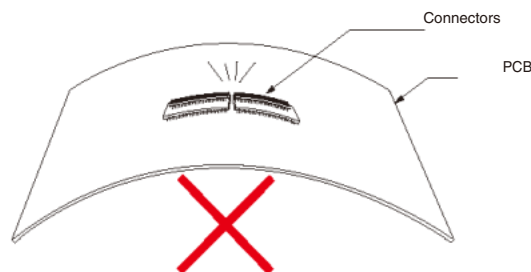

◆When hand soldering:

- Do not perform hand soldering with the FPC inserted in the connector.
 - * Do not apply excessive heat or touch the soldering iron anywhere other than the connector leads.
 - * Do not use excessive amount of solder or flux compounds.
- Operation of the actuator or contacts may be affected by excessive amounts of solder or flux compounds.

■Temperature Profile

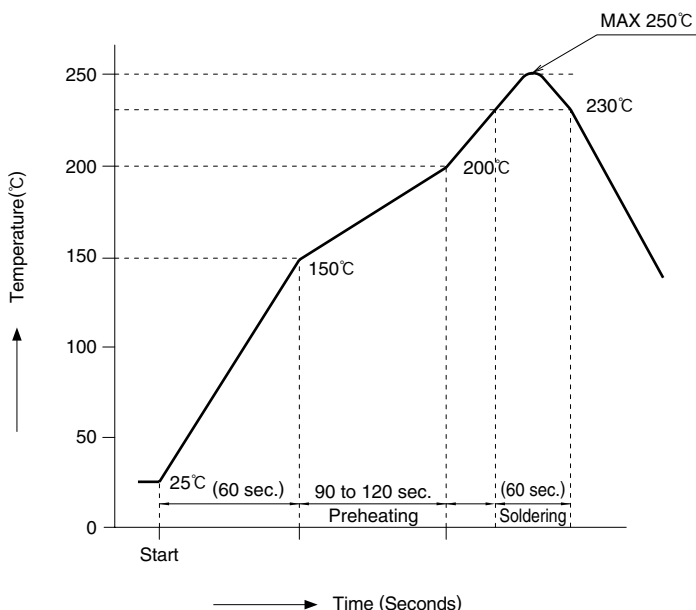

HRS test condition

Solder method	: Reflow, IR/hot air
Environment	: Room air
Solder composition	: Paste, 96.5%Sn/3.0%Ag/0.5%Cu (Senju Metal Industry, Co., Ltd.'s Part Number: M705-221CM5-42-10.5)
Test board	: Glass epoxy 25mm×40mm×0.8mm thick
Land dimensions	: 0.3mm×0.8mm
Metal mask	: 0.25×0.65×0.1mm thick

The temperature profiles shown are based on the above conditions.

In individual applications the actual temperature may vary, depending on solder paste type, volume / thickness and board size / thickness. Consult your solder paste and equipment manufacturer for specific recommendations.

Looking for pricing, stock, or lifecycle information?

Click below to explore more details on WIN SOURCE:

- [View FH34S-14S-0.5SH\(50\) on WIN SOURCE](#)
- [Hirose Electric Co Ltd Information](#)

Optimize Your Supply Chain with WIN SOURCE Solutions

- ✓ Global Sourcing Solution
- ✓ Obsolete Management
- ✓ Cost Control Management
- ✓ Shortage Management
- ✓ Alternative Solution
- ✓ Excess Inventory Management