



**THE DATASHEET OF
DF19G-14P-1H(56)**



DF19 Series

1.0mm Pitch, Low Profile Wire-to-Board, FPC-to-Board, Micro-coaxial Cable-to-Board Connectors



Low Profile



Thin coaxial



FPC

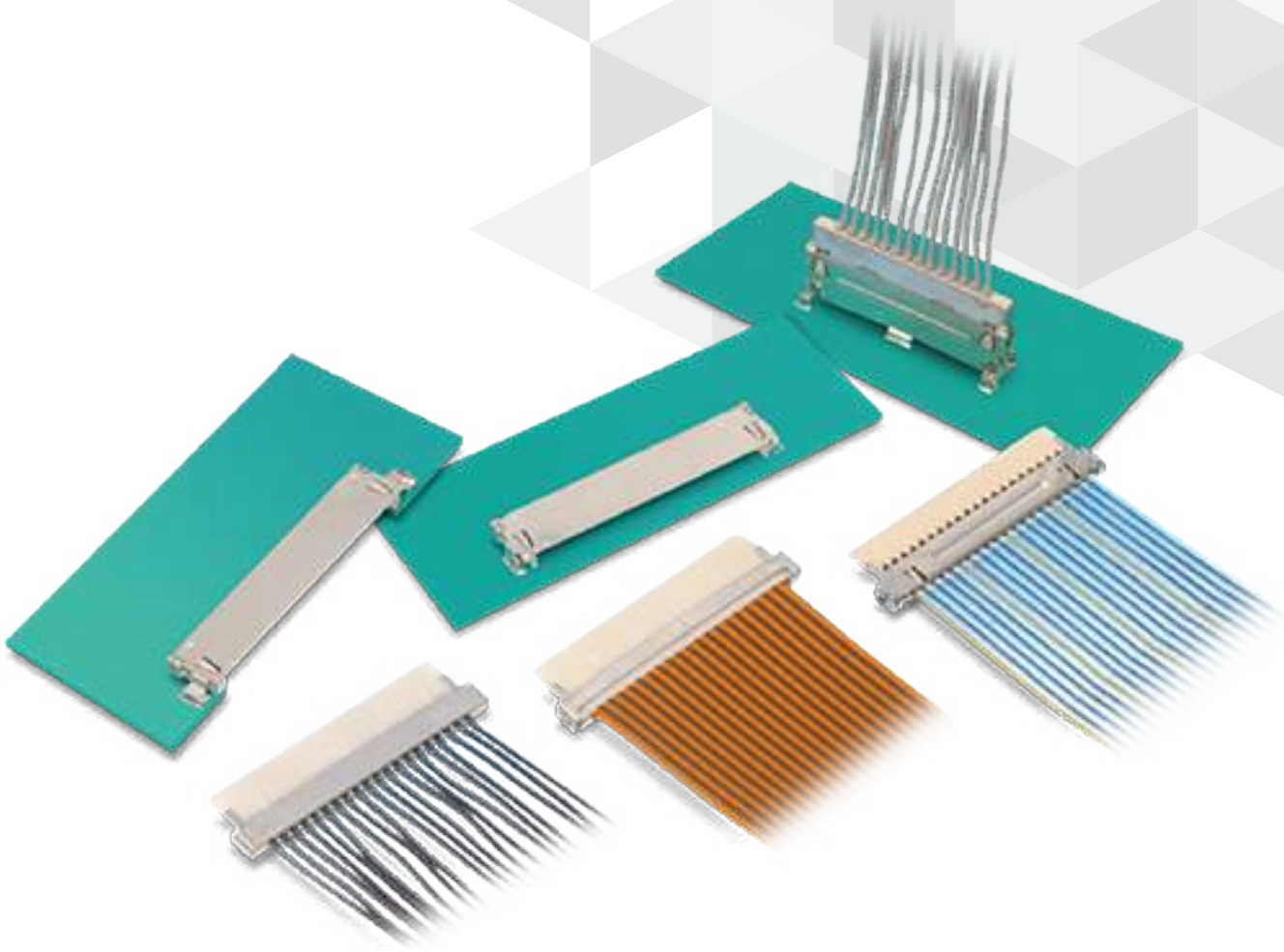

Jun.1.2024 Copyright 2024 HIROSE ELECTRIC CO., LTD. All Rights Reserved.



Features

1. De Facto Standard for LCD Panel Connection

DF19 has been accepted as the market standard for LCD panels (12in. or less) due to its high performance for LVD high speed differential signals.

2. Low Profile Design

Cable, micro-coaxial type : 1.5mm thickness (1.6mm Max.)
 FPC Type : 1.7mm Max.

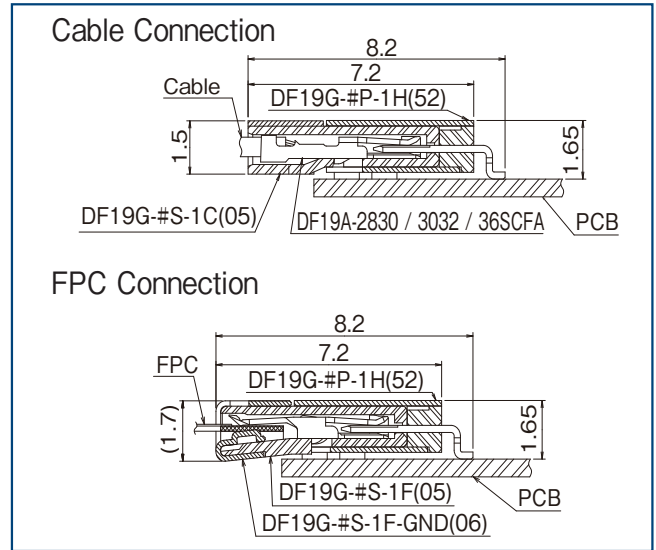

3. Common Header

Header is compatible with the 3 socket types (discrete wire, FPC and micro-coaxial types), for a wide selection of mating combinations.

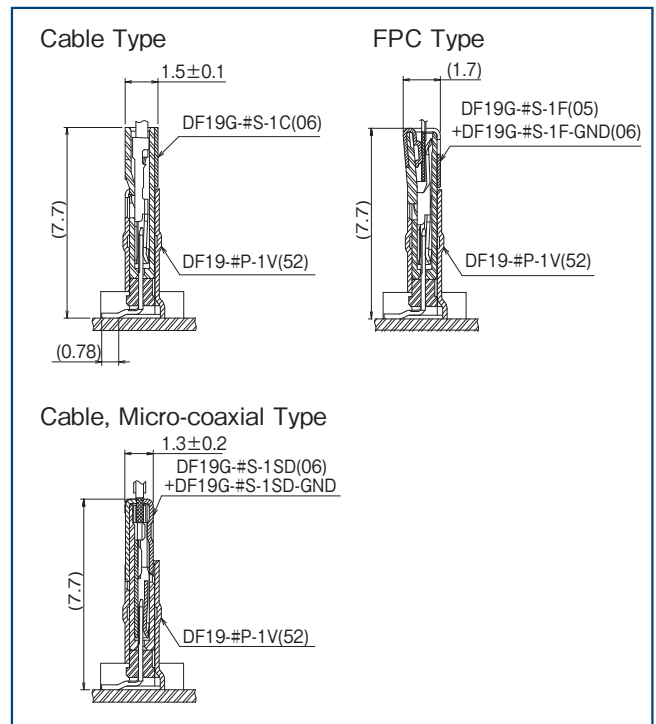

4. Uniform External Dimensions

External dimensions of each socket type are the same and can be used in a wide array of applications.

5. Wide Varieties

Header is available in top-board, offset, reverse mount offset and vertical mounted styles to meet a wide array of application needs.

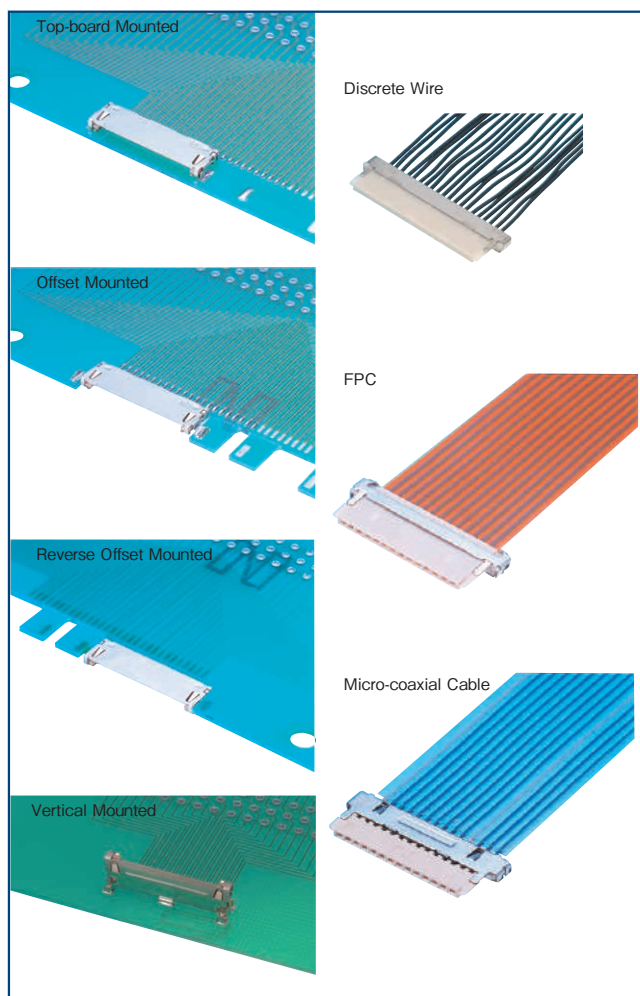

6. Ground Connection with Outer Shell

Metal shell enables ground connection.

7. Glow Wire Compatible (IEC60695-2-11 Standard)

Applications

Mobile phones, LCD connections, DVC, DSC, PDA, camera modules, and other small equipment

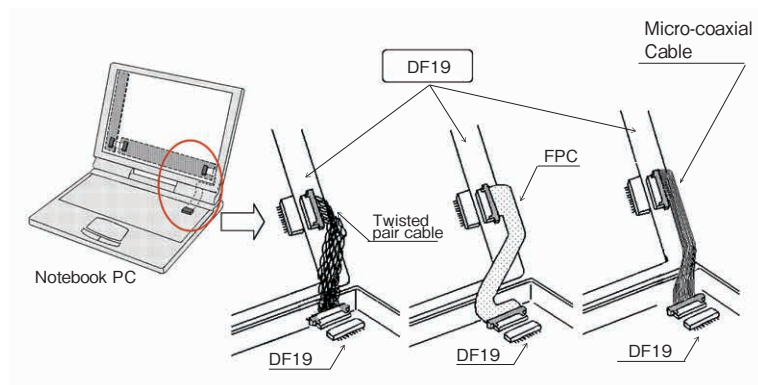

Product Specifications

Rated Current	28 AWG	30 AWG	32 AWG	36 AWG	FPC	Micro-coaxial Cable 40 AWG	Operating Temperature (Note 1)	-35 to +85°C
	1A/pin	0.9A/pin	0.8A/pin	0.5A/pin	0.5A/pin	0.3A/pin	Operating Humidity Range (Note 2)	40 to 80%
Rated Voltage	100V AC/DC						Storage Temperature Range (Note 3)	-10 to +60°C
							Storage Humidity Range (Note 3)	40 to 70%

Note 1 : Includes temperature rise due to current flow.

Note 2 : Please use without condensation.

Note 3 : Applicable to unused items in packaged state.

Note 4 : Information contained in this catalog represents general requirements for this Series. Contact us for the drawings and specifications for a specific part number shown.

Item	Specification	Conditions
Insulation Resistance	500M Ω Min.	100V DC
Withstanding Voltage	No flashover or insulation breakdown.	300V AC for 1 min.
Contact Resistance	30m Ω Max. (50m Ω Max. for FPC)	1mA
Vibration	No electrical discontinuity of 1 μs or more.	Frequency : 10 to 55 Hz, single amplitude of 0.75mm, in 3 direction for 10 cycles
Humidity (Steady State)	Contact Resistance : 30m Ω Max. (50m Ω Max. for FPC) Insulation Resistance : 500M Ω Min.	96 hours at temperature of 40 ± 2°C and humidity of 90 to 95%
Temperature Cycle	Contact Resistance : 30m Ω Max. (50m Ω Max. for FPC) Insulation Resistance : 500M Ω Min.	Temperature : -55°C → +5 to +35°C → +85°C → +5 to +35°C Time (Minutes) : 30 → 10 → 30 → 10 for 5 cycles
Mating Durability	Contact Resistance : 30m Ω Max. (50m Ω Max. for FPC)	30 cycles
Soldering Heat Resistance	No deformation of the insulator parts affecting performance.	Re-flow soldering : At the recommended temperature profile Manual soldering : Soldering iron temperature 350°C , 5 seconds

Materials / Finish

Product	Component	Material	Finish / Color	Remarks	RoHS2
Pin Header	Insulator	Polyamide	Black or Beige	UL94V-0	○
	Contacts	Phosphor Bronze	Partially Gold Plated	-	
	Exterior Shell	Phosphor Bronze	Partially Tin Plated	-	
Crimp Case	Insulator	Polyamide	Beige	UL94V-0	
	Exterior Shell	Stainless Steel	Tin Plated	-	
Socket Crimp Contact	Contact	Phosphor Bronze	Gold Plated	-	
FPC Socket	Insulator	Polyamide	Beige	UL94V-0	
	Contact	Phosphor Bronze	Gold Plated	-	
FPC Grounding Plate	Exterior Shell	Stainless Steel	Tin Plated	-	
Micro-coaxial Socket	Insulator	LCP	Beige	UL94V-0	
	Contact	Phosphor Bronze	Partially Gold Plated	-	
	Exterior Shell	Phosphor Bronze	Tin Plated	-	
Grounding Plate for Micro-Coaxial	Exterior Shell	Phosphor Bronze	Tin Plated	-	

Product Number Structure

Refer to the chart below when determining the product specifications from the product number.
Please select from the product numbers listed in this catalog when placing orders.

Connector

DF19 # - # P - 1 H (52)

① ② ③ ④ ⑤ ⑥ ⑧

DF19 # - # S - 1 F - GND

① ② ③ ④ ⑤ ⑥ ⑦

① Series Name	DF19	③ No. of Pos.	8, 14, 20, 30 (Note 1)
② Configuration	Pin Header G : Top-board Mouted (1.65mm Height) K : Offset Mounted (1.0mm Height) L : Offset Mounted (1.1mm Height) KR : Reverse Offset Mounted Version of DF19K (1.0mm Height) Crimp Socket Blank : No Exterior Shell G : With Exterior Shell (EMI Prevention Specification) FPC Socket G : With Grounding Plate Grounding Plate for FPC G : With Grounding Plate Micro-coaxial Socket G : With Grounding Plate Grounding Plate for Micro-coaxial Cable G : With Grounding Plate	④ Connector Type	S : Single Row Socket P : Single Row Pin Header
		⑤ Contact Pitch	1.0mm
		⑥ Mounting Type/ Termination Type	H : Right Angle SMT V : Straight SMT C : Crimp Case F : FPC, Socket SD : Micro-coaxial Socket
		⑦ Attachable Parts	GND : Ground plate (Note 2)
		⑧ Specification	(52) : Gold plated, tape & reel packaging

Note 1 : The pin count availabilities vary based on connection style.

Note 2 : Grounding plates are required when terminating with the FPC and Micro-coaxial cable.

Crimp Contact

DF19A - 2830 SCF A (##)

① ② ③ ④

① Conductor Size	2830 : 28-30 AWG 3032 : 30-32 AWG 36 : 36 AWG	③ Plating	A : Gold Plated
② Contact Type/ Packaging	SCF : Socket Contact, Reel	④ Packaging	Blank : 10,000pcs per reel (41) : 20,000pcs per reel

Right Angle Pin Header (SMT) (Top-Board Mounted Type)

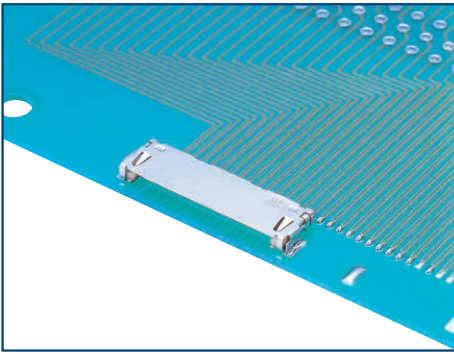

Pictured mounted on board.

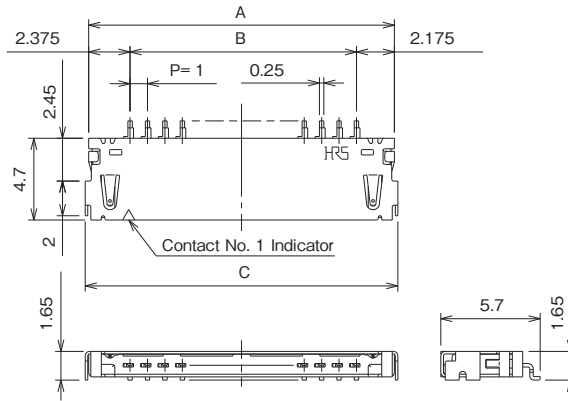

Recommended PCB Mounting Pattern

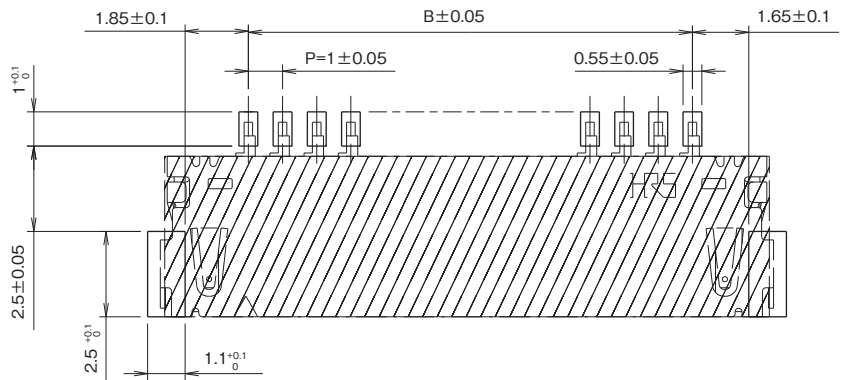

Note : If there is a pattern on the portion and resist is not applied, it may come into contact with the ground plate.

Unit : mm

Part No.	HRS No.	No. of Pos.	A	B	C	Remarks	Purchase Unit
DF19G-8P-1H(52)	CL0685-0021-0-52	8	11.55	7.0	11.95	1.65mm Height Above Board	1,000pcs per reel
DF19G-14P-1H(52)	CL0685-0004-0-52	14	17.55	13.0	17.95		
DF19G-20P-1H(52)	CL0685-0006-6-52	20	23.55	19.0	23.95		
DF19G-30P-1H(52)	CL0685-0015-7-52	30	33.55	29.0	33.95		

Note : When using in combination with the single row socket (FPC Type), mount on the edge of the PCB.

Right Angle Pin Header (SMT) (Offset Mounted Type)

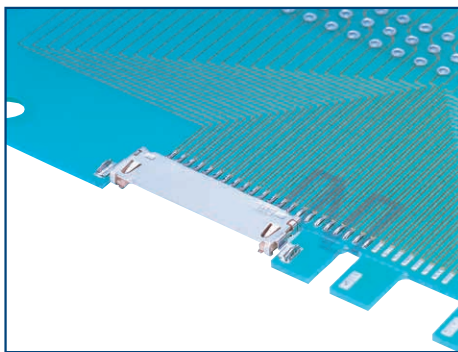

Pictured mounted on board.

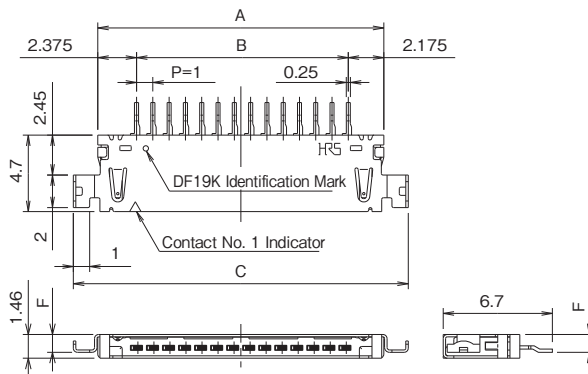

Recommended PCB Mounting Pattern

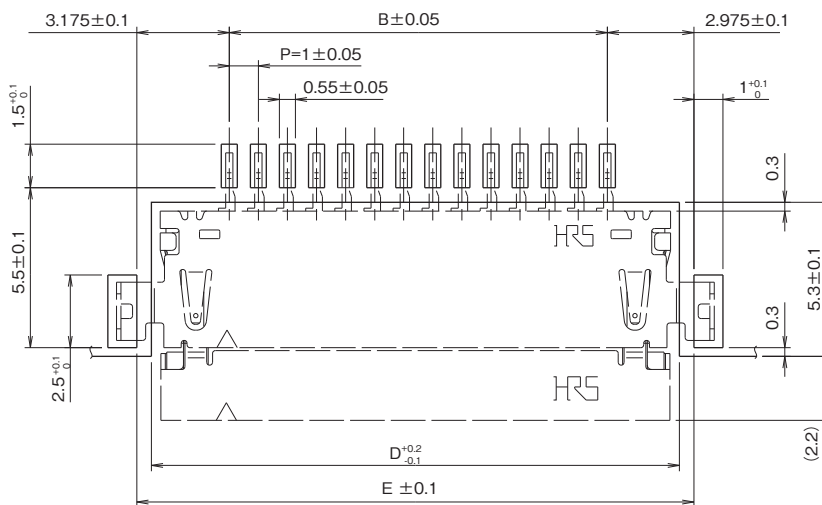

Unit : mm

Part No.	HRS No.	No. of Pos.	A	B	C	D	E	F	Remarks	Purchase Unit
DF19K-20P-1H(52)	CL0685-0008-1-52	20	23.55	19.0	26.55	24.15	25.15	1.0	1.0mm Height Above Board	1,000pcs per reel
DF19K-30P-1H(52)	CL0685-0032-6-52	30	33.55	29.0	36.55	34.15	35.15	1.0		
DF19L-14P-1H(52)	CL0685-0003-8-52	14	17.55	13.0	20.55	18.15	19.15	1.1	1.1mm Height Above Board	
DF19L-20P-1H(52)	CL0685-0019-8-52	20	23.55	19.0	26.55	24.15	25.15	1.1		
DF19L-30P-1H(52)	CL0685-0016-0-52	30	33.55	29.0	36.55	34.15	35.15	1.1		

Right Angle Pin Header (SMT) (Reverse Offset Mounted Type)

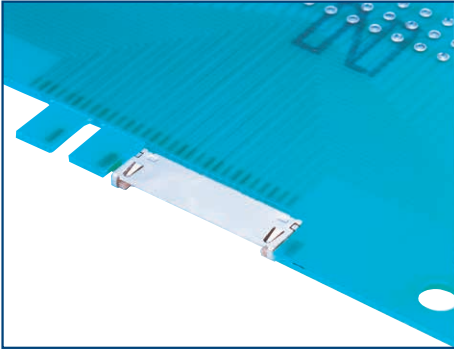

Pictured mounted on board.

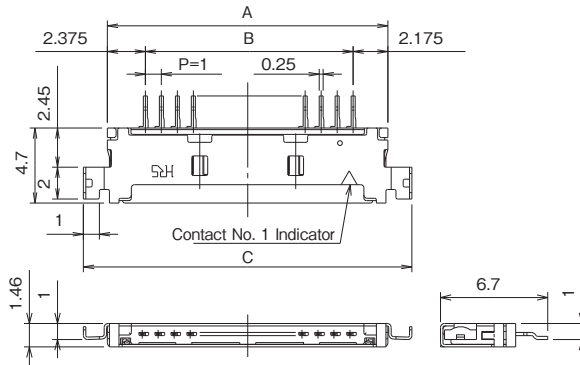

Recommended PCB Mounting Pattern

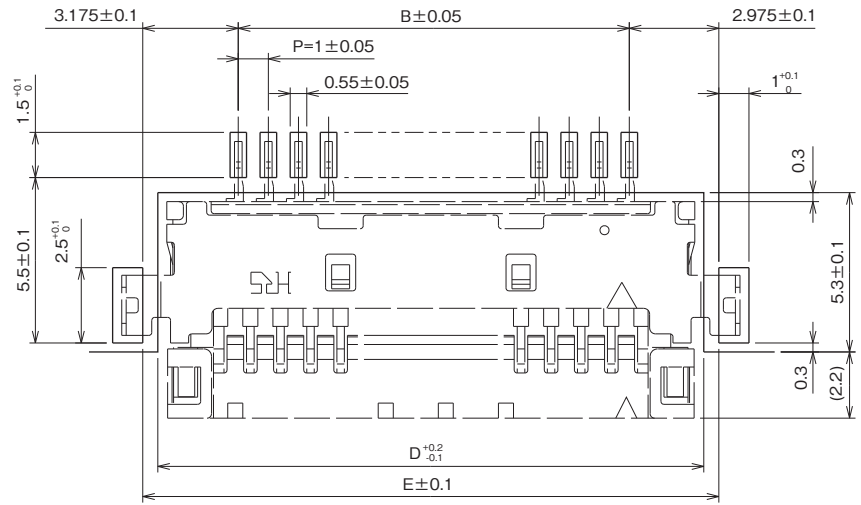

Unit : mm

Part No.	HRS No.	No. of Pos.	A	B	C	D	E	Remarks	Purchase Unit
DF19KR-20P-1H(52)	CL0685-0023-5-52	20	23.55	19.0	26.55	24.15	25.15	1.0mm Height Above Board	1,000pcs per reel

Straight Pin Header (SMT)

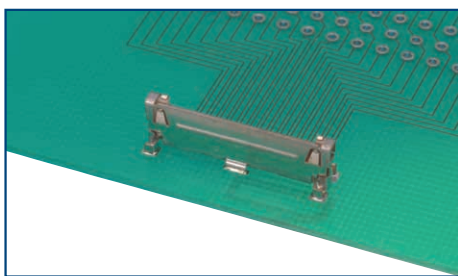

Pictured mounted on board.

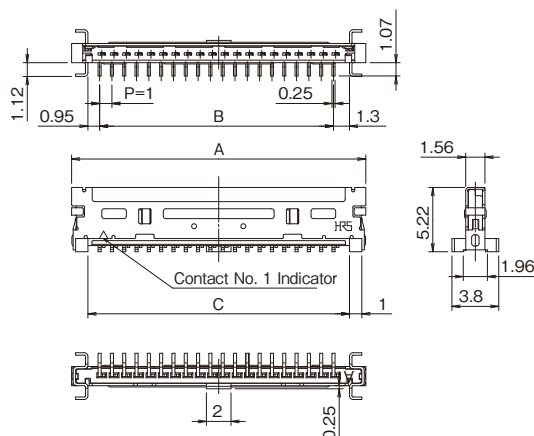

Recommended PCB Mounting Pattern

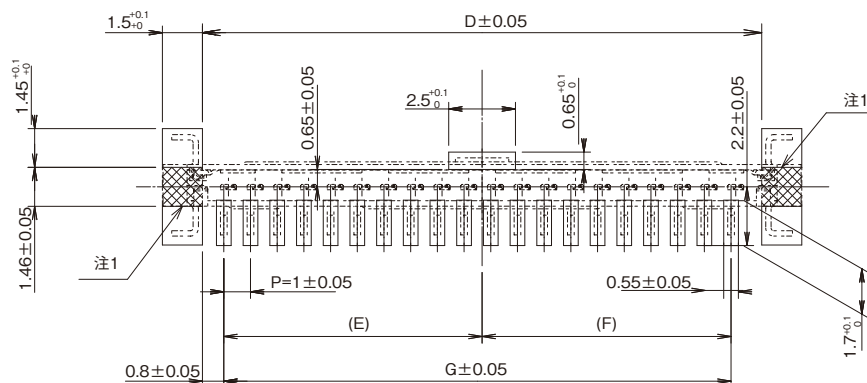

Note : If there is a pattern on the portion and resist is not applied, it may come into contact with the ground plate.

Unit : mm

Part No.	HRS No.	No. of Pos.	A	B	C	D	E	F	G	Purchase Unit
DF19-14P-1V(52)	CL0685-0036-7-52	14	17.9	13.0	15.25	14.95	6.675	6.325	13.0	1,000pcs per reel
DF19-20P-1V(52)	CL0685-0037-0-52	20	23.9	19.0	21.25	20.95	9.675	9.325	19.0	

Single Row Socket (Cable Type)



Shown with terminated and installed contacts

DF19-#S-1C

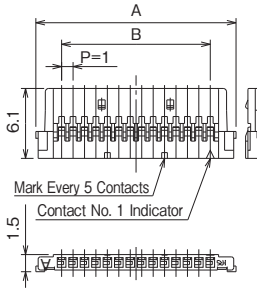

DF19G-#S-1C (06)

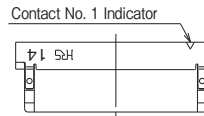
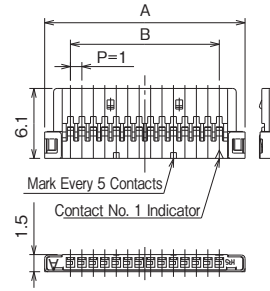

Unit : mm

Part No.	HRS No.	No. of Pos.	A	B	Purchase Unit
DF19-8S-1C	CL0685-0029-1-00	8	11.5	7.0	100pcs per bag
DF19-14S-1C	CL0685-0012-9-00	14	17.5	13.0	
DF19-20S-1C	CL0685-0011-6-00	20	23.5	19.0	
DF19-30S-1C	CL0685-0013-1-00	30	33.5	29.0	

With Exterior Shell (EMI Prevention Specification)

Unit : mm

Part No.	HRS No.	No. of Pos.	A	B	Purchase Unit
DF19G-8S-1C(06)	CL0685-0022-2-06	8	11.5	7.0	100pcs per bag
DF19G-14S-1C(06)	CL0685-0005-3-06	14	17.5	13.0	
DF19G-20S-1C(06)	CL0685-0007-9-06	20	23.5	19.0	
DF19G-30S-1C(06)	CL0685-0014-4-06	30	33.5	29.0	

Socket Crimp Contacts

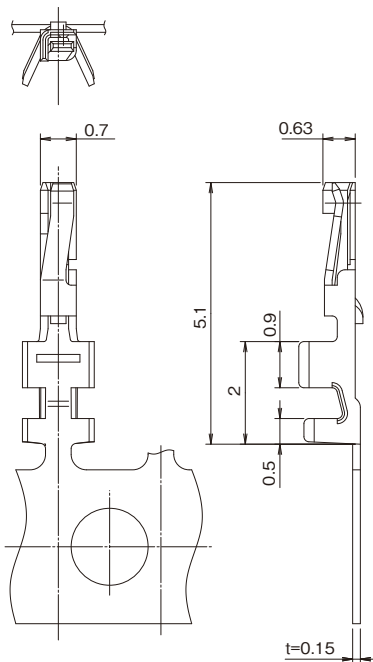
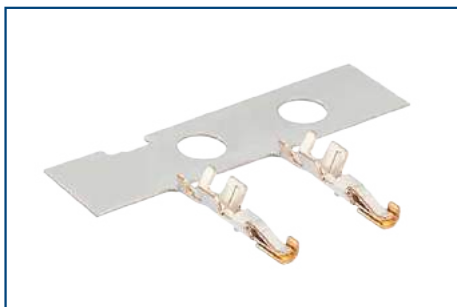

Part No.	HRS No.	Purchase Unit (##) : Blank	Purchase Unit (##) : (41)
DF19A-2830SCFA(##)	CL0685-0048-6-##	10,000pcs per reel	20,000pcs per reel
DF19A-3032SCFA(##)	CL0685-0046-0-##		
DF19A-36SCFA(##)	CL0685-0047-3-##		

Applicable Wire (Tin Plated Annealing Copper Wire)

Part No.	UL	Wire Size	Stranded Wire Structure	Sectional Area	Jacket Diameter	Strip Length
DF19A-2830SCFA(##)	1571 (Thin Type)	28 AWG	7/0.127mm	0.089mm ²	φ 0.5-0.6mm	1.2-1.9mm
DF19A-3032SCFA(##)		30 AWG	7/0.1mm	0.055mm ²		
		32 AWG	7/0.08mm	0.035mm ²		
DF19A-36SCFA(##)		36 AWG	7/0.05mm	0.014mm ²	φ 0.27mm	

Note 1 : Please contact a Hirose sales representative when using cables other than those specified.

Note 2 : Contact your Hirose sales representative when using 36 AWG.

Applicable Tools

Type	Part No.	HRS No.	Applicable Contact
Applicator	AP105-DF19S	CL0901-4571-3-00	DF19A-2830SCFA(##) DF19A-3032SCFA(##)
Press Unit	CM-105C	CL0901-0001-0-00	-

Note 1 : Please conduct crimping work according to the "Crimping Quality Standard" (ETAD-H0945-00)" and "Crimping Condition Table".

Note 2 : Issues with non-Hirose specified tools are outside the scope of warranty.

Note 3 : Contact your Hirose sales representative when using 36 AWG.

Note 4 : When non-authorized tools are used, please consult with Hirose sales representative about provision of the drawing of the crimping tool.

Single Row Socket (FPC Type)

Note : Socket and grounding plate is required.

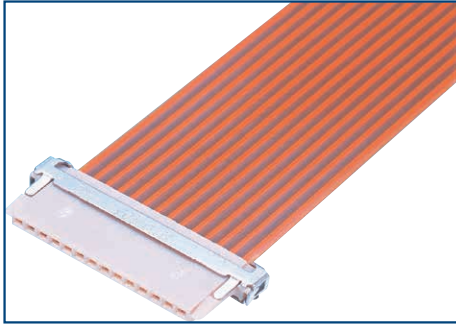

Shown terminated with FPC.

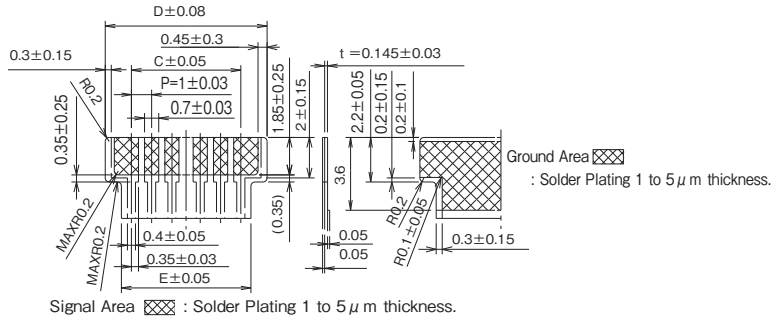
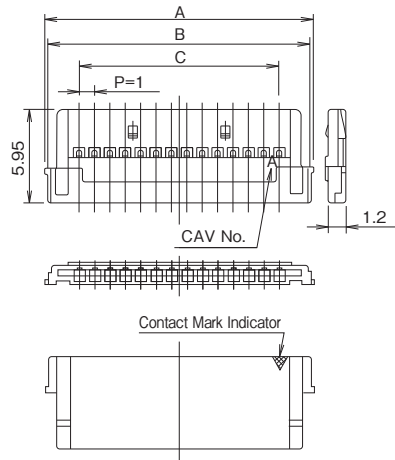

Unit : mm

Part No.	HRS No.	No. of Pos.	A	B	C	D	E	Purchase Unit
DF19G-14S-1F(05)	CL0685-0017-2-05	14	17.5	17.1	13.0	15.6	14.0	100pcs per bag
DF19G-20S-1F(05)	CL0685-0009-4-05	20	23.5	23.1	19.0	21.6	20.0	
DF19G-30S-1F(05)	CL0685-0033-9-05	30	33.5	33.1	29.0	31.6	30.0	

Note : When using in combination with the right angle pin header (Top Board Type), mount on the edge of the PCB.

Ground Plate for FPC

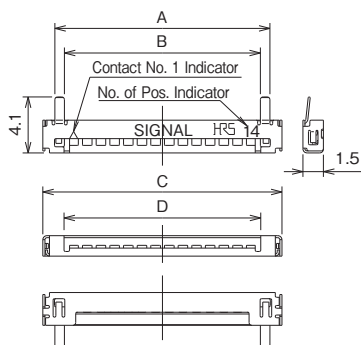

Unit : mm

Part No.	HRS No.	No. of Pos.	A	B	C	D	Purchase Unit
DF19G-14S-1F-GND(06)	CL0685-0018-5-06	14	15.75	14.35	17.5	14.4	100pcs per bag
DF19G-20S-1F-GND(06)	CL0685-0010-3-06	20	21.75	20.35	23.5	20.4	
DF19G-30S-1F-GND(06)	CL0685-0034-1-06	30	31.75	30.35	33.5	30.4	

Applicable Assembly Tools

Type	Part No.	HRS No.
Desktop tool (for 14pos.)	DF19G-14S/PR-MD2	CL0902-4514-6-00
Desktop tool (for 20pos.)	DF19G-20S/PR-MD2	CL0902-4513-3-00
Desktop tool (for 30pos.)	DF19G-30S/PR-MD2	CL0902-4518-7-00

Note : Issues caused by tools other than those specified for Hirose are outside the scope of warranty.

Single Row Socket (Micro-coaxial)

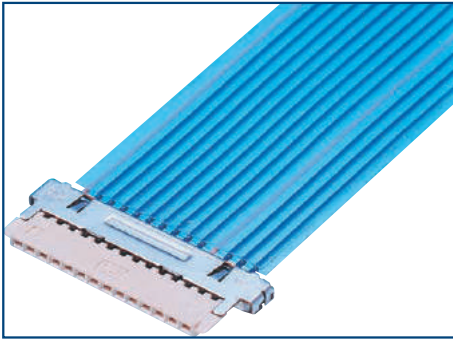

Shown terminated with micro-coaxial cable.

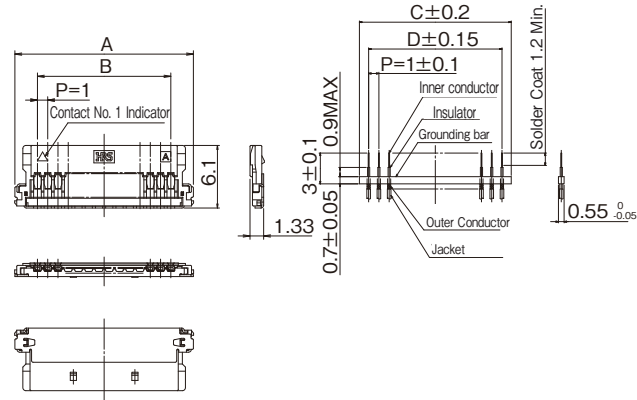

- Note 1 : The pitch misalignment prevention tape can be connected without cutting, but please use a durable material.
- Note 2 : The inner conductor must be soldered in advance.
- Note 3 : When using a two position coaxial line, there are some pin arrangements that cannot be used due connector protrusion. Please check the official specifications.

Unit : mm

Part No.	HRS No.	No. of Pos.	A	B	C	D	Purchase Unit
DF19G-14S-1SD(06)	CL0685-0026-3-06	14	17.4	13.0	14.8	13.0	100pcs per bag
DF19G-20S-1SD(06)	CL0685-0025-0-06	20	23.4	19.0	20.8	19.0	

Applicable Cable (Micro-coaxial Cable)

Wire Size (Core Wire Configuration)	Jacket Diameter
40 AWG (7 / 0.03mm)	φ 0.3-0.4mm

Grounding Plate for Micro-coaxial Cable

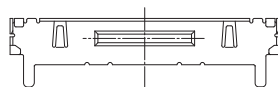
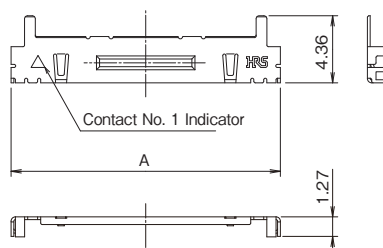
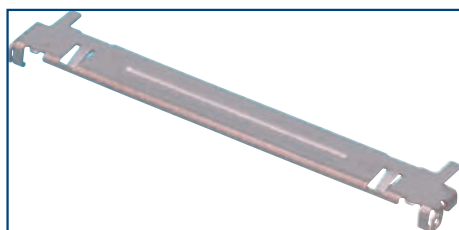

Unit : mm

Part No.	HRS No.	No. of Pos.	A	Purchase Unit
DF19G-14S-1SD-GND	CL0685-0028-9-00	14	17.5	100pcs per bag
DF19G-20S-1SD-GND	CL0685-0027-6-00	20	23.5	

Embossed Carrier Tape Dimensions (JIS-C-0806 Standard)

- DF19G-#P-1H(52)
- DF19K-#P-1H(52)
- DF19L-#P-1H(52)

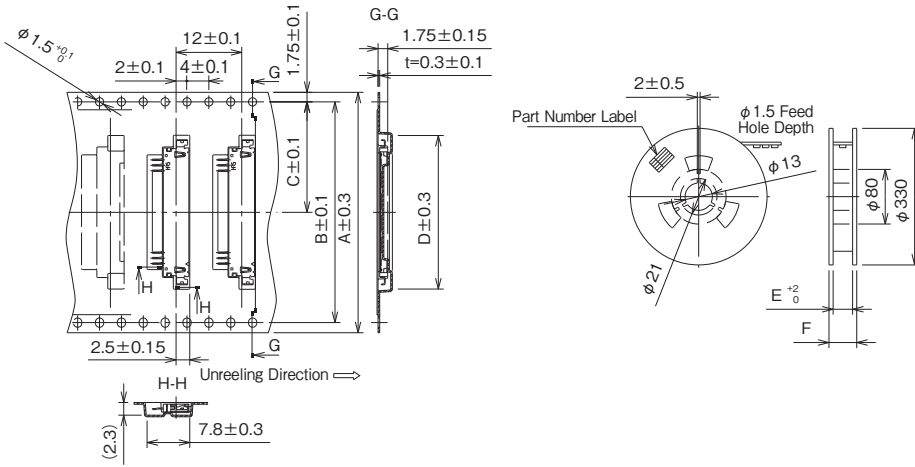

Unit : mm

Part No.	No. of Pos.	A	B	C	D	E	F	Remarks
DF19G-8P-1H(52)	8	24.0	-	11.5	16.1	24.4	30.4	Top-board Mounted (1.65mm Height)
DF19G-14P-1H(52)	14	44.0	40.4	20.2	22.1	44.4	50.4	
DF19G-20P-1H(52)	20	44.0	40.4	20.2	28.1	44.4	50.4	
DF19G-30P-1H(52)	30	56.0	50.2	26.2	38.1	56.4	62.4	Offset Mounted (1.0mm Height)
DF19K-20P-1H(52)	20	44.0	40.4	20.2	28.1	44.4	50.4	
DF19K-30P-1H(52)	30	56.0	52.4	26.2	38.1	56.4	62.4	Offset Mounted (1.1mm Height)
DF19L-14P-1H(52)	14	44.0	40.4	20.2	22.1	44.4	50.4	
DF19L-20P-1H(52)	20	44.0	40.4	20.2	28.1	44.4	50.4	
DF19L-30P-1H(52)	30	56.0	52.4	26.2	38.1	56.4	62.4	

●DF19KR-20P-1H(52)

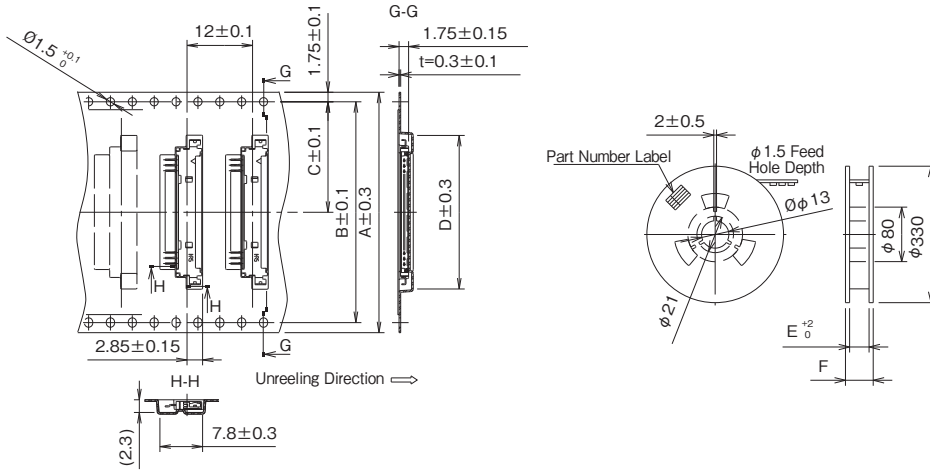

Unit : mm

Part No.	No. of Pos.	A	B	C	D	E	F	Remarks
DF19KR-20P-1H(52)	20	44.0	40.4	20.2	28.1	44.4	50.4	Reverse type of DF19K Offset Mounted (1.0mm Height)

●DF19-#P-1V(52)

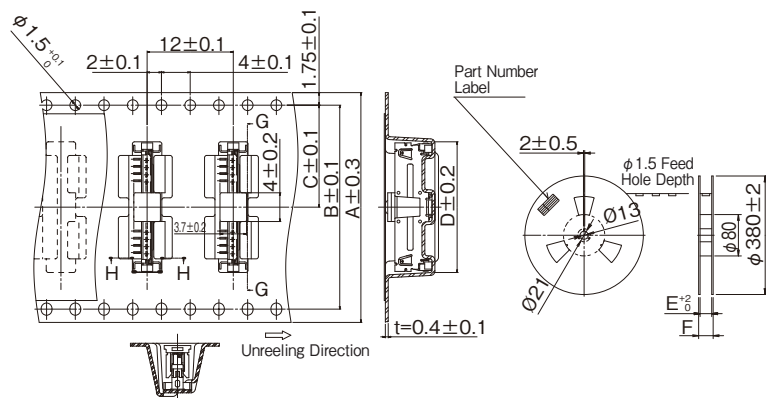

Unit : mm

Part No.	No. of Pos.	A	B	C	D	E	F	Remarks
DF19-14P-1V(52)	14	32.0	28.4	14.2	18.2	32.4	38.4	Straight Type
DF19-20P-1V(52)	20	44.0	40.4	20.2	24.2	44.4	50.4	

Crimping Precautions

■ Items Required Prior to Crimping

The work-related documents shown below are required before starting harness assembly.

(The ● mark represents required documents.)

Please contact your Hirose sales representative if you do not have these documents.

Document Title	Description	Automatic Crimping Machine	Hand Crimping Tool	Remarks
① Crimping Machine Main Unit Instruction Manual	Explanation of main press unit	●	-	Bundled with purchase of main press machine unit.
② Applicator Instruction Manual	Crimp Method	●	-	Bundled with purchase of applicator.
③ Applicator Spare Parts List	Applicator Installation Instruction	●	-	
④ Crimp Conditions	Crimp height, tensile strength standard value	●	-	
⑤ Crimp Quality Standards	Various standards for crimping conditions	●	-	
⑥ Hand Tool Operating Instructions	Crimp method, crimp height and tensile height standard value	-	●	Bundled with purchase of hand tool.
⑦ Cable Assembly	Cable assembly	●	●	Contact a Hirose sales representative.

■ Tools

- Use tools designated by Hirose when crimping.
- Crimping performed using tools other than those specified is outside the scope of warranty.
- The operating instructions are available for the crimping machine and the applicator. Be sure to carefully read the operating instructions manual before beginning work.

■ Applicable Cables

Check that the cables to be used are within the applicable range.

If you intend to use a cable other than those recommended, contact a sales representative.

[Precautions]

- Cables applicable to crimping connectors are tin-plated stranded soft-copper wire.
- Avoid crimping solid wire, wires with polyester threads or tin coated wires.
- Avoid crimping two cables together.
- The crimp height setting values (Note) may vary between tin-plated and gold-plated terminals even if the same electric wires are used.
- The crimp height setting values (Note) may vary depending on the difference in the core wire configuration even if the computed cross-sectional area is the same.

Note : The crimp height is an important item that determines crimping quality. We execute crimping tests for each electric wire to ensure the optimal value for the crimp height with high precision, thereby ensuring optimal setup values.

Precautions

<p>1. Recommended Temperature Profile</p>	<p>Temperature (°C)</p> <p>250°C</p> <p>200°C</p> <p>150°C</p> <p>100°C</p> <p>50°C</p> <p>30 50 100 150 200</p> <p>Time(S)</p> <p>220</p> <p>180</p> <p>Preheating</p> <p>60 to 120s</p> <p>Soldering</p> <p>250°C 10s Max.</p> <p>220°C Min. 60s Max.</p> <p>Note 1 : Up to 2 cycles of reflow soldering are possible under the same conditions, provided that there is a return to normal temperature between the first and second cycle.</p> <p>Note 2 : The temperature profile indicates the temperature of the surface of the connector lead.</p> <p>Note 3 : The color of the grounding plate may change color, although this does not affect the product performance.</p>
<p>2. Recommended Manual Soldering Conditions</p>	<p>Manual soldering : $350 \pm 10^\circ\text{C}$ for 5 seconds</p>
<p>3. Recommended Metal Mask Thickness</p>	<p>0.15mm</p>
<p>4. Board Warpage</p>	<p>Maximum of 0.03mm at the connector center, with both ends of the connector as reference points.</p>
<p>5. Cleaning Conditions</p>	<p>Refer to "Wire-to-Board Connector Use Handbook."</p>
<p>6. Termination Conditions</p>	<p>Refer to "Wire-to-Board Connector Use Handbook."</p>
<p>7. Cautions</p>	<ul style="list-style-type: none"> ■ Excessive prying during mating and unmating may result in damage. ■ Black spots may appear on the mold resin but this does not affect the product quality.
<p>8. Handling</p>	<p>Please refer to the following documents when handling the product.</p> <ul style="list-style-type: none"> ■ Crimp Quality Standard (ETAD-H9045-00) ■ Wire-to-Board Connector Use Handbook ■ Cable Assembly Procedure (ETAD-H0963-00)

Single Row Socket (FPC Type) Assembly Method

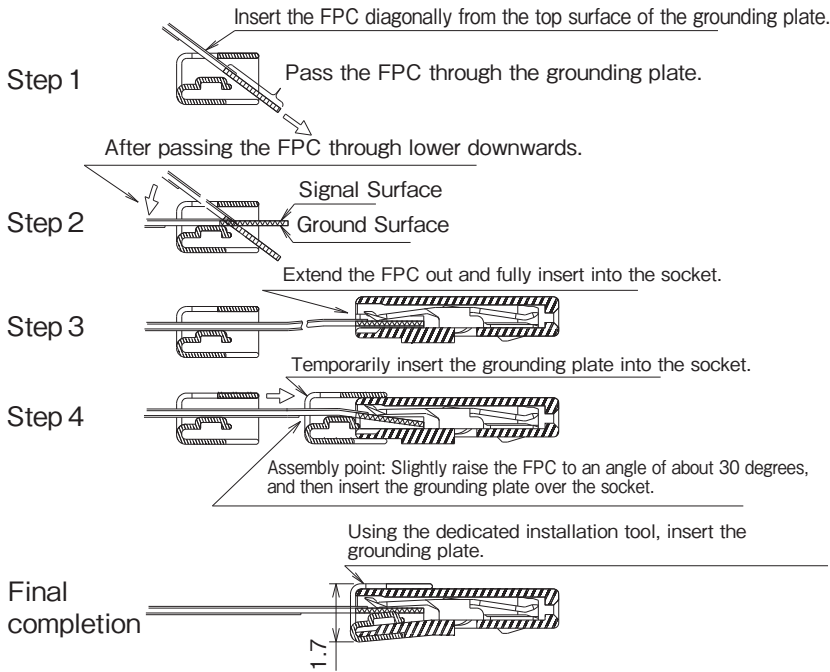

Note 1 : The grounding plate and the socket are supplied as separate components.

Note 2 : Dedicated assembly tools are required for assembly.

Note 3 : When temporarily inserting the ground plate, the FPC can be easily inserted by lightly lifting the FPC up to 30° and designing a self-alignment guide.

However, if excessive force (bending, twisting, etc.) is applied to the FPC, the FPC (edge of the cover film) copper foil may crack.

Note 4 : If the ground plate cannot be inserted, make sure it is aligned parallel to the socket and do not force it in.

Note 5 : To protect the FPC, insert and remove the connector parallel to the mating surface.

Note 6 : To protect the FPC, do not apply excessive tension.

Note 7 : Refer to the FPC manufacture recommended bending radius and other specifications. Distance should be allowed for bending as shown below.

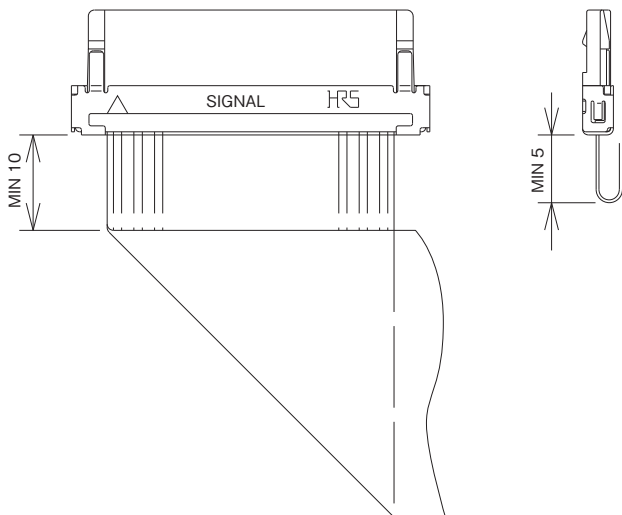

Note 8 : When terminating the FPC there is a risk of misuse of the tools, or injury from the ridge on the metal part of the connector, etc. Follow the terminal tools instruction manual to ensure proper termination.

While Taking into Consideration

Specifications mentioned in this catalog are reference values.

When considering to order or use this product, please review the Drawing and Product Specifications sheets.

Use an appropriate cable when using the connector in combination with cables.

If considering usage of a non-specified cable, please contact your sales representative.

If assembly process is done by jigs & tools which are not identified by Hirose, the warranty of the product may be affected.

If considering usage for below mentioned applications, please contact your sales representative.

In cases where the application will demand a high level of reliability, such as automotive, medical instruments, public infrastructure, aerospace/ defense etc. Hirose must review before assurance of reliability can be given.

HIROSE**HIROSE ELECTRIC CO.,LTD.**2-6-3 Nakagawa Chuoh, Tsuzuki-Ku, Yokohama-Shi 224-8540, JAPAN
<https://www.hirose.com>

Looking for pricing, stock, or lifecycle information?

Click below to explore more details on WIN SOURCE:

- [View DF19G-14P-1H\(56\) on WIN SOURCE](#)
- [Hirose Electric Co Ltd Information](#)

Optimize Your Supply Chain with WIN SOURCE Solutions

- ✓ Global Sourcing Solution
- ✓ Obsolete Management
- ✓ Cost Control Management
- ✓ Shortage Management
- ✓ Alternative Solution
- ✓ Excess Inventory Management