



**THE DATASHEET OF
A8L-11-15N2**



Miniature Rocker Switch

A8L

Miniature Rocker Switch for High Capacity Switching

- Withstands inrush currents up to 100 A with a unique switching mechanism.
- Soft touch with firm switching action.
- Easy to mount by snap fitting.
- Contact gap of 3 mm minimum.
- UL and cUL standards approved. Conforms to EN standards.



RoHS Compliant

⚠ Caution
Refer to Precautions

■ List of Models

Contact Form		SPST					Quantity per box
Terminals		Solder terminals	PCB terminals	Right-angled PCB terminals	Left-angled PCB terminals	Quick-connect terminals #187	Quantity per box
Color of caps and cases		Black	Black	Black	Black	Black	
Marking on caps	Without markings	A8L-11-11N1	A8L-11-12N1	A8L-11-13N1	A8L-11-14N1	A8L-11-15N1	300
		A8L-11-11N2	A8L-11-12N2	A8L-11-13N2	A8L-11-14N2	A8L-11-15N2	
		A8L-11-11N3	A8L-11-12N3	A8L-11-13N3	A8L-11-14N3	A8L-11-15N3	
		A8L-11-11N6	A8L-11-12N6	A8L-11-13N6	A8L-11-14N6	A8L-11-15N6	

Contact Form		DPST					Quantity per box
Terminals		Solder terminals	PCB terminals	Right-angled PCB terminals	Left-angled PCB terminals	Quick-connect terminals #187	Quantity per box
Color of caps and cases		Black	Black	Black	Black	Black	
Marking on caps	Without markings	A8L-21-11N1	A8L-21-12N1	A8L-21-13N1	A8L-21-14N1	A8L-21-15N1	300
		A8L-21-11N2	A8L-21-12N2	A8L-21-13N2	A8L-21-14N2	A8L-21-15N2	
		A8L-21-11N3	A8L-21-12N3	A8L-21-13N3	A8L-21-14N3	A8L-21-15N3	
		A8L-21-11N6	A8L-21-12N6	A8L-21-13N6	A8L-21-14N6	A8L-21-15N6	

Note: Simple dust-proof models are available. Consult your OMRON representative.

■ Ratings

Rated load	Non-inductive		Inductive	
	Resistive load	Lamp load	Inductive load	Inductive motor load
125 VAC	10 A	10 A	8 A	8 A
250 VAC	10 A	10 A	8 A	8 A

- Note:**
1. The non-inductive lamp load has an inrush current 10 times steady current.
 2. The inductive load has a power factor of 0.4 minimum (AC).
 3. The motor load has an inrush current 6 times steady current.

The above ratings were tested under the following conditions:

1. Ambient temperature: $20 \pm 2^\circ\text{C}$
2. Ambient humidity: $65 \pm 5\% \text{RH}$
3. Switching frequency: 7 times/min

■ Approved Safety Standards

UL, cUL (UL1054/CSA C22.2 No. 55)

10 A, 125 VAC; 10 A, 250 VAC

TÜV (EN61058-1)

10 (8) A, 250 VAC

■ Characteristics

Permissible operating frequency	Mechanical	20 operations/min max.
	Electrical	7 operations/min max.
Insulation resistance		100 M Ω min. (at 500 VDC with insulation tester)
Contact resistance (initial value)		100 m Ω max. (6 to 8 VDC, 1 A, voltage drop method)
Dielectric strength	Between terminals of the same polarity	2,000 VAC, 50/60 Hz, for 1 min
	Between terminals of the different polarity	2,000 VAC, 50/60 Hz, for 1 min
	Between charged metal parts and the ground terminal	4,000 VAC, 50/60 Hz, for 1 min
Vibration resistance	Malfunction	10 to 55 Hz, 1.5-mm double amplitude
Shock resistance	Malfunction	300 m/s ²
	Destruction	500 m/s ²
Durability	Mechanical	50,000 operations min.
	Electrical	10,000 operations min.
Inrush current		100 A max. (8.3 ms max.)
Degree of protection		IEC IP40
Ambient operating temperature		-20 to +55°C (with no icing or condensation)
Ambient operating humidity		45 to 85%RH

Note: Consult your OMRON representative for details of performance characteristics with respect to individual standards.

■ Dimensions (Unit: mm)

Note: The following illustrations and drawings are for 2 poles (DPST) models, 1 pole (SPST) models have single side terminals.

Solder Terminals

A8L-11-11N1 A8L-21-11N1
 A8L-11-11N2 A8L-21-11N2
 A8L-11-11N3 A8L-21-11N3
 A8L-11-11N6 A8L-21-11N6

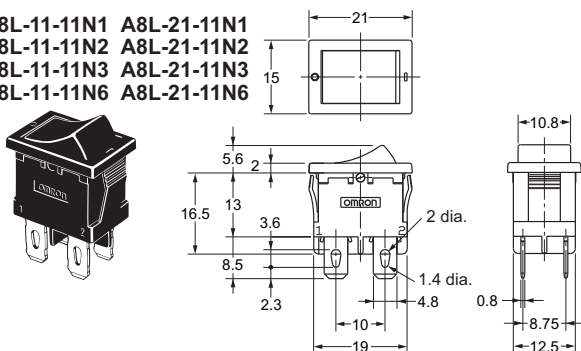

■ Operating Characteristics

No. of poles	1 (SPST)	2 (DPST)
Operating force (OF)	2.16 \pm 1.18 N {220 \pm 120 gf}	3.92 \pm 2.45 N {400 \pm 250 gf}

Note: Unless otherwise specified, a tolerance of ± 0.4 mm applies to all dimensions.

PCB Terminals

A8L-11-12N1 A8L-21-12N1
 A8L-11-12N2 A8L-21-12N2
 A8L-11-12N3 A8L-21-12N3
 A8L-11-12N6 A8L-21-12N6

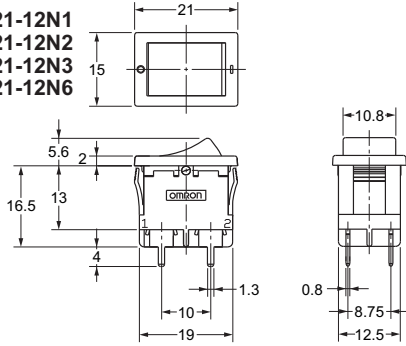
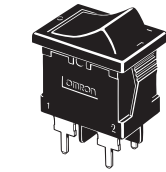

PCB Dimensions (Bottom View)

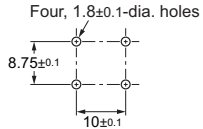

Operating Characteristics

No. of poles	1 (SPST)	2 (DPST)
Operating force(OF)	2.16±1.18 N {220±120 gf}	3.92±2.45 N {400±250 gf}

Right-angled PCB Terminals

A8L-11-13N1 A8L-21-13N1
 A8L-11-13N2 A8L-21-13N2
 A8L-11-13N3 A8L-21-13N3
 A8L-11-13N6 A8L-21-13N6

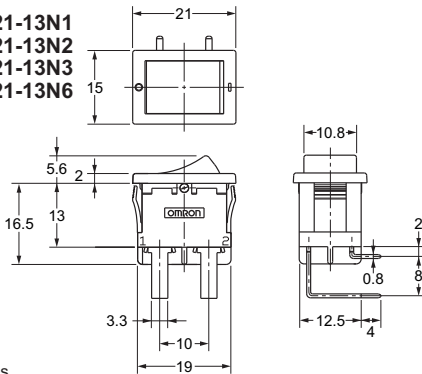
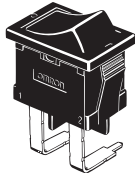

PCB Dimensions (Bottom View)

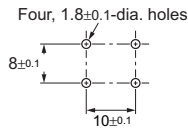

Operating Characteristics

No. of poles	1 (SPST)	2 (DPST)
Operating force(OF)	2.16±1.18 N {220±120 gf}	3.92±2.45 N {400±250 gf}

Left-angled PCB Terminals

A8L-11-14N1 A8L-21-14N1
 A8L-11-14N2 A8L-21-14N2
 A8L-11-14N3 A8L-21-14N3
 A8L-11-14N6 A8L-21-14N6

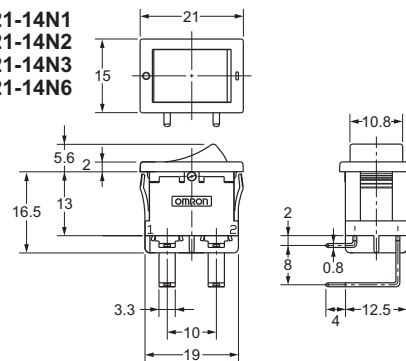
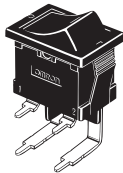

PCB Dimensions (Bottom View)

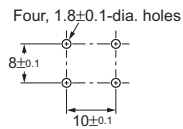

Operating Characteristics

No. of poles	1 (SPST)	2 (DPST)
Operating force(OF)	2.16±1.18 N {220±120 gf}	3.92±2.45 N {400±250 gf}

Note: Unless otherwise specified, a tolerance of ±0.4 mm applies to all dimensions.

Quick-connect Terminals #187

A8L-11-15N1 A8L-21-15N1
 A8L-11-15N2 A8L-21-15N2
 A8L-11-15N3 A8L-21-15N3
 A8L-11-15N6 A8L-21-15N6

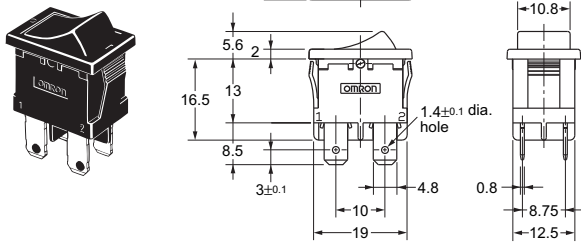

Operating Characteristics

No. of poles	1 (SPST)	2 (DPST)
Operating force(OF)	2.16±1.18 N {220±120 gf}	3.92±2.45 N {400±250 gf}

Note: Unless otherwise specified, a tolerance of ±0.4 mm applies to all dimensions.

Panel Cutout

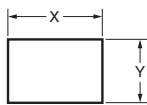

Panel thickness (mm)	X (mm)	Y (mm)
0.75 to 1.25	19.2 ⁰ _{-0.1}	12.9 ^{+0.1} ₀
1.26 to 2.5	19.4 ^{+0.1} _{-0.3}	12.9 ^{+0.1} ₀

Note: Recommended panel material: SPCC

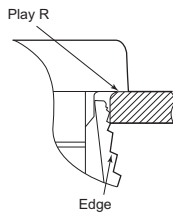

When processing the panel, be sure that the Play R is on the switch operation side.
 Be sure that the Edge is on the reverse side of panel when processing.

Precautions

Be sure to read the Safety precautions common to all Rocker Switches for correct use.

Panel Cutout for Angled PCB Terminals

(A8L-□□-□3□□, A8L-□□-□4□□)

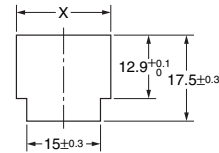



Panel thickness (mm)	X (mm)
0.75 to 1.25	19.2 ⁰ _{-0.1}
1.26 to 2.5	19.4 ^{+0.1} _{-0.3}

- Application examples provided in this document are for reference only. In actual applications, confirm equipment functions and safety before using the product.
- Consult your OMRON representative before using the product under conditions which are not described in the manual or applying the product to nuclear control systems, railroad systems, aviation systems, vehicles, combustion systems, medical equipment, amusement machines, safety equipment, and other systems or equipment that may have a serious influence on lives and property if used improperly. Make sure that the ratings and performance characteristics of the product provide a margin of safety for the system or equipment, and be sure to provide the system or equipment with double safety mechanisms.

Note: Do not use this document to operate the Unit.

Looking for pricing, stock, or lifecycle information?

Click below to explore more details on WIN SOURCE:

-  [View A8L-11-15N2 on WIN SOURCE](#)
-  [Omron Information](#)

Optimize Your Supply Chain with WIN SOURCE Solutions

-  Global Sourcing Solution
-  Obsolete Management
-  Cost Control Management
-  Shortage Management
-  Alternative Solution
-  Excess Inventory Management