



**THE DATASHEET OF
HLC2701-001**



HLC2701

Encoder Detector

FEATURES

- Side-looking plastic package
- TTL/LSTTL/CMOS compatible
- Inverting logic output
- Linear or rotary encoder applications
- Resolution to 0.009 in. (.229 mm)
- Sensitivity versus temperature compensation
- Mechanically and spectrally matched to SEP8506 and SEP8706 infrared emitting diodes

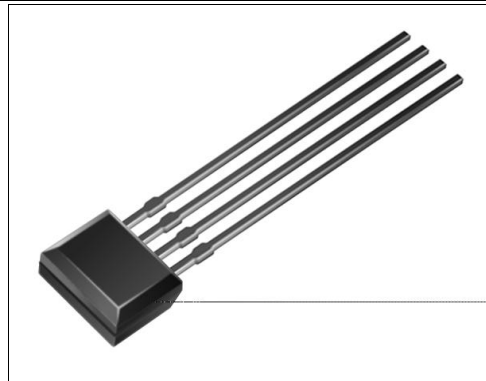

INFRA-74.TIF

DESCRIPTION

The HLC2701 detector is designed to sense speed and direction of mechanical motion. Applications include rotary and linear encoders; the device is especially well suited for the encoding function in an optical mouse.

The detector is a monolithic IC, consisting of two narrow adjacent photodiodes, amplifiers, and Schmitt trigger output stages. The outputs are NPN collectors with internal 10 kΩ (nominal) pull-up resistors to V_{CC} which can directly drive TTL loads. It incorporates circuitry to compensate the sensitivity for the output power versus temperature characteristics of an IRED. The IC is encapsulated in a molded, unlensed black plastic package which is transmissive to IR energy, yet provides shielding from visible light.

In a typical application, the HLC2701 is used in conjunction with an IRED and an encoder disk or linear encoder strip attached to an element for which speed and direction of movement is to be sensed. As the interruptive pattern moves, the sensor provides two phase shifted output signals (active low) which can be processed to provide the speed and direction information.

The sensing areas of the IC are each 0.008 in. (.203 mm) in width and in .015 in. (.381 mm) in height with a 0.001 in. (.0254 mm) separation, for center-to-center spacing of 0.009 in. (.203 mm), and outside edge to edge distance of 0.017 in. (.432 mm).

OUTLINE DIMENSIONS in inches (mm)

Tolerance	3 plc decimals	±0.005(0.12)
	2 plc decimals	±0.020(0.51)

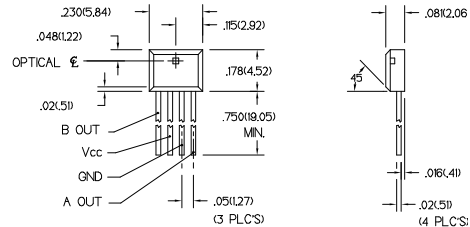

DIM_030.cdr

HLC2701

Encoder Detector

ELECTRICAL CHARACTERISTICS (-40°C to +85°C unless otherwise noted)

PARAMETER	SYMBOL	MIN	TYP	MAX	UNITS	TEST CONDITIONS
Operating Supply Voltage	V _{CC}	4.5	5.5		V	
Turn-on Threshold Irradiance ⁽²⁾	E _{ET(+)}				mW/cm ²	V _{CC} =5 V
HLC2701-001		0.05	2.0			T _A =25°C
Hysteresis ⁽³⁾	HYST		28		%	
Supply Current	I _{CC}		7.0		mA	V _{CC} =5.25 V
High Level Output Voltage (A and B)	V _{OH}	2.4			V	V _{CC} =5 V I _{OH} =0, E _e =0
Low Level Output Voltage (A and B)	V _{OL}		0.4		V	V _{CC} =5 V, I _{OL} =1.6 mA E _e =2.0 mW/cm ²
Internal Pull-Up Resistor	R _{INT}	5.0	10.0	20.0	kΩ	
Operate Point Temperature Coefficient	O _{PTC}		-0.76		%/°C	Emitter @ Constant Temperature
Output Rise Time, Output Fall Time	t _r , t _f		100		ns	V _{CC} =5 V R _L =1 kΩ T _A =25°C
Propagation Delay, Low-High, High-Low	t _{PLH} , t _{PHL}		5.0		μs	V _{CE} =5 V R _L =1 kΩ T _A =25°C

Notes

1. It is recommended that a bypass capacitor, 0.1 μF typical, be added between V_{CC} and GND near the device in order to stabilize power supply line.
2. The radiation source is an IRED with a peak wavelength of 880 nm.
3. Hysteresis is defined as the difference between the operating and release threshold intensities, expressed as a percentage of the operate threshold intensity.

ABSOLUTE MAXIMUM RATINGS

(25°C Free-Air Temperature unless otherwise noted)

Duration of Output

Short to V _{CC} or Ground	1.0 sec.
Operating Temperature Range	-40°C to 85°C
Storage Temperature Range	-40°C to 85°C
Soldering Temperature (5 sec)	240°C

Honeywell reserves the right to make changes in order to improve design and supply the best products possible.

Honeywell

HLC2701

Encoder Detector

FUNCTIONAL BLOCK DIAGRAM

SCH_045.cdr

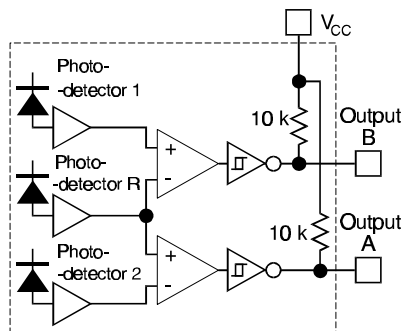

SWITCHING WAVEFORM

cir_011.cdr

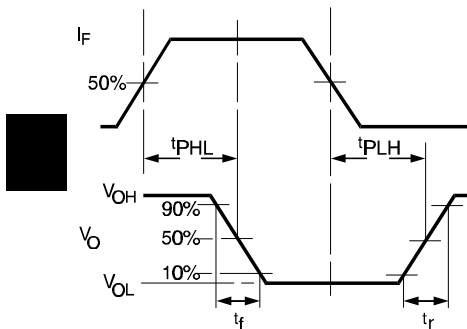
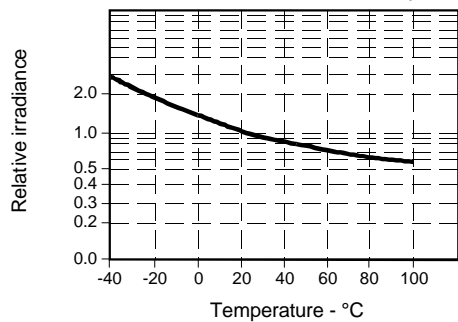

Fig. 2 Threshold Irradiance vs Temperature

gra_060.ds4



SWITCHING TIME TEST CIRCUIT

cir_014.cdr

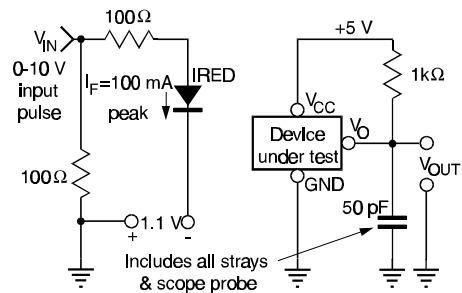

Fig. 1 Responsivity vs Angular Displacement

gra_066.ds4

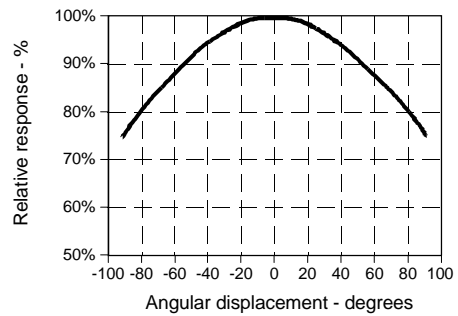
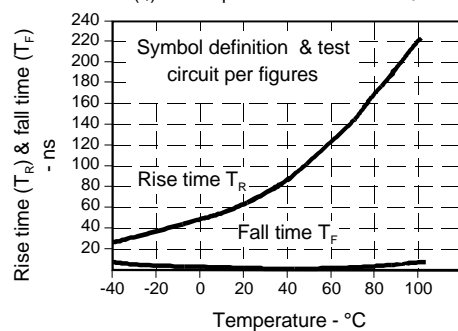

Fig. 3 Output Rise Time (t_r) and Output Fall Time (t_f) vs Temperature

gra_061.ds4



HLC2701

Encoder Detector

Fig. 4 Delay Time vs Temperature

gra_062.ds4

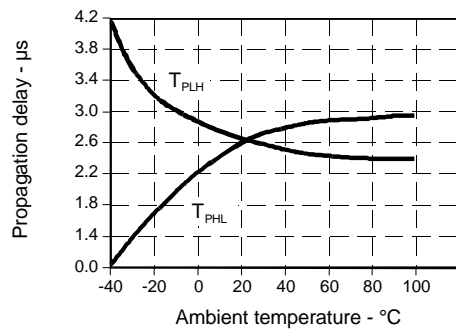
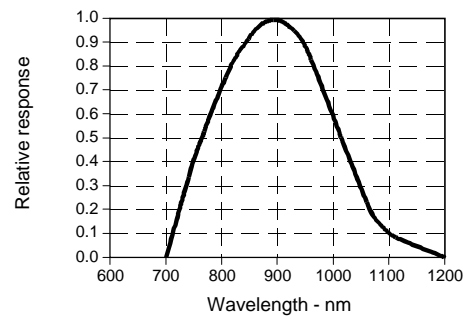

Fig. 5 Spectral Responsivity



gra_050.ds4



All Performance Curves Show Typical Values

Looking for pricing, stock, or lifecycle information?

Click below to explore more details on WIN SOURCE:

-  [View HLC2701-001 on WIN SOURCE](#)
-  [Honeywell Information](#)

Optimize Your Supply Chain with WIN SOURCE Solutions

-  Global Sourcing Solution
-  Obsolete Management
-  Cost Control Management
-  Shortage Management
-  Alternative Solution
-  Excess Inventory Management