



## HIGH RELIABILITY FAST RECOVERY RECTIFIER

Qualified per MIL-PRF-19500/308

- 150°C Junction Temperature
- VRRM 50 to 400 Volts
- 50 Amps Current Rating

### DEVICES

1N3909	1N3912	1N3910A	1N3913A	1N3911R	1N3909AR	1N3912AR
1N3910	1N3913	1N3911A	1N3909R	1N3912R	1N3910AR	1N3913AR
1N3911	1N3909A	1N3912A	1N3910R	1N3913R	1N3911AR	

LEVELS  
 JAN  
 JANTX  
 JANTXV

### ABSOLUTE MAXIMUM RATINGS (T<sub>C</sub> = +25°C unless otherwise noted)

Parameters / Test Conditions	Symbol	Value	Unit
Peak Reverse Voltage	V <sub>RWM</sub>	50	V
		100	
		200	
		300	
		400	
Peak Working Reverse Voltage	V <sub>RRM</sub>	50	V
		100	
		200	
		300	
		400	
Average Forward Current, T <sub>C</sub> = 100°	I <sub>F</sub>	50	A
Peak Surge Forward Current @ 8.3ms, half sinewave, T <sub>C</sub> = 100°C	I <sub>FSM</sub>	300	A
		400	
Thermal Resistance, Junction to Case	R <sub>θJC</sub>	0.8	°C/W
Operating Case Temperature Range	T <sub>j</sub>	-65°C to 150°C	°C
Storage Temperature Range	T <sub>STG</sub>	-65°C to 175°C	°C

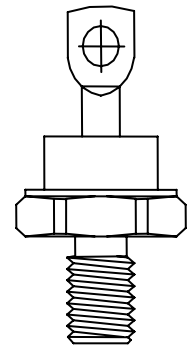

DO-203AB (DO-5)

### ELECTRICAL CHARACTERISTICS (T<sub>A</sub> = +25°C, unless otherwise noted)

Parameters / Test Conditions	Symbol	Min.	Max.	Unit
Forward Voltage I <sub>FM</sub> = 50A, T <sub>C</sub> = 25°C*	V <sub>FM</sub>		1.4	V
Forward Voltage I <sub>FM</sub> = 400A, T <sub>C</sub> = 150°C**	V <sub>FM</sub>		2.75	V
Reverse Current V <sub>RM</sub> = 50V, T <sub>C</sub> = 25°C	I <sub>RM</sub>		15	μA
V <sub>RM</sub> = 100V, T <sub>C</sub> = 25°C				
V <sub>RM</sub> = 200V, T <sub>C</sub> = 25°C				
V <sub>RM</sub> = 300V, T <sub>C</sub> = 25°C				
V <sub>RM</sub> = 400V, T <sub>C</sub> = 25°C				
Reverse Current V <sub>RM</sub> = 50V, T <sub>C</sub> = 150°C	I <sub>RM</sub>		6	mA
V <sub>RM</sub> = 100V, T <sub>C</sub> = 150°C				
V <sub>RM</sub> = 200V, T <sub>C</sub> = 150°C				
V <sub>RM</sub> = 300V, T <sub>C</sub> = 150°C				
V <sub>RM</sub> = 400V, T <sub>C</sub> = 150°C				
Reverse Recovery Time V <sub>RM</sub> = 30V, I <sub>F</sub> = 1A	T <sub>rr</sub>		200	ns
			150	

\* Pulse test: Pulse width 300 μsec, Duty cycle 2%

\*\* Pulse test: Pulse width 800 μsec

## HIGH RELIABILITY FAST RECOVERY RECTIFIER

### GRAPHS

**FIGURE 1**

**TYPICAL FORWARD CHARACTERISTICS**

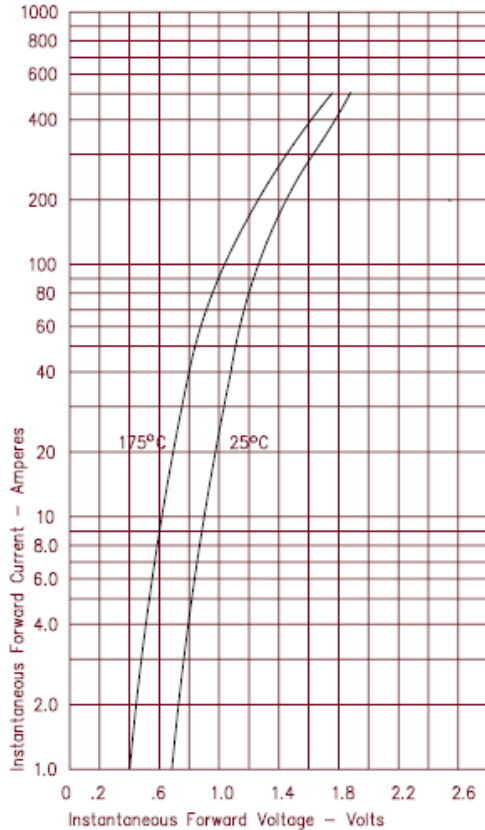

**FIGURE 3**

**TYPICAL JUNCTION CAPACITANCE**

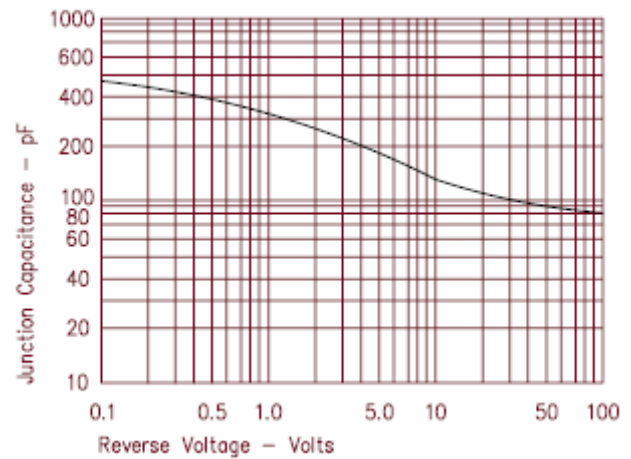

**FIGURE 4**

**FORWARD CURRENT DERATING**

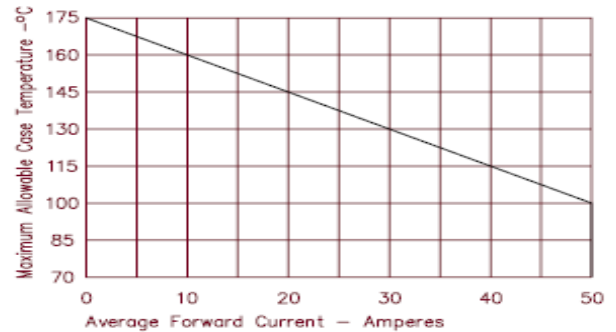

**FIGURE 2**

**TYPICAL REVERSE CHARACTERISTICS**

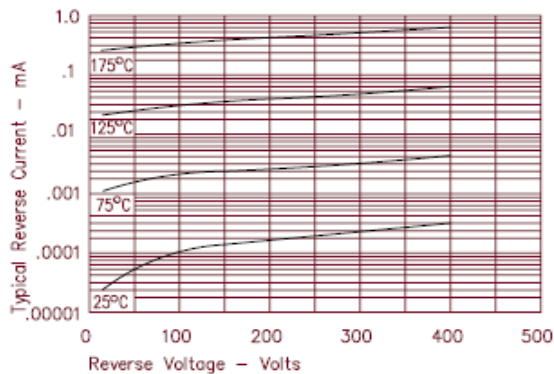

## HIGH RELIABILITY FAST RECOVERY RECTIFIER

### PACKAGE DIMENSIONS

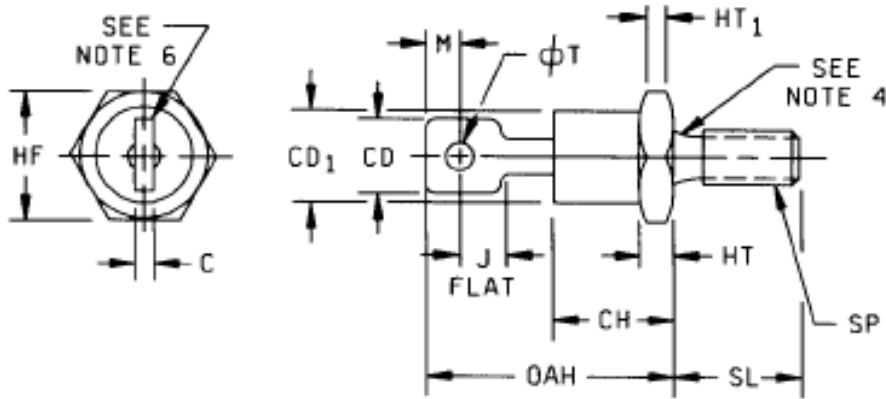

#### NOTES:



1. Dimensions are in inches.
2. Metric equivalents are given for general information only.
3. Units must not be damaged by torque of 30 inch-pounds applied to 0.250-28 UNF-2B nut assembled on thread.
4. Diameter of unthreaded portion 0.249 inch (6.32 mm) max and 0.220 inch (5.59 mm) minimum.
5. Complete threads to extend to within 2.5 threads of seating plane.
6. Angular orientation for this terminal is underlined, however the major surfaces over dimension CD shall be flat and the minimum distance from the hole to any point on the periphery shall be 0.030 inch (0.76mm) outside dimension J.
7. Max pitch diameter of plated threads shall be basic pitch diameter 0.2268 inch (5.76 mm) reference FED-STD-H28.
8. (Screw Thread Standards for Federal Services.)
9. A chamfer or undercut on one or both ends of the hex portion is optional: Minimum base diameter at seating plane. 0.600 inch (15.24 mm)
10. Reversed (anode to stud) units shall be marked with an "R" following the last digit in the type number.

Ltr	Dimensions			
	Inches		Millimeters	
	Min	Max	Min	Max
C	0.030	0.080	0.76	2.03
CD	0.250	0.375	6.35	9.52
CD1		0.667		16.94
CH		0.450		11.43
HF	0.669	0.688	16.99	17.48
HT	0.115	0.200	2.93	5.08
HT1	0.060		1.53	
J	0.156		3.97	
M	0.030		0.77	
OAH	0.750	1.000	19.05	25.40
$\phi T$	0.140	0.175	3.56	04.44
SL	0.422	0.453	10.72	11.50
SP	.250-28 UNF-2A THD NF optional		6.35-28 UNF-2A THD NF optional	

Physical dimensions (DO-5)

## Looking for pricing, stock, or lifecycle information?

Click below to explore more details on WIN SOURCE:

-  [View 1N3910R on WIN SOURCE](#)
-  [Microchip Technology](#) Information

## Optimize Your Supply Chain with WIN SOURCE Solutions

-  Global Sourcing Solution
-  Obsolete Management
-  Cost Control Management
-  Shortage Management
-  Alternative Solution
-  Excess Inventory Management