



**THE DATASHEET OF
BA820**



Tone ringer IC for telephone set

BA8206 / BA8206F

The BA8206 and BA8206F are tone ringer ICs which produce a bell sound from a ringing signal. The frequency of the bell sound can be varied by changing the constants of the external resistance and capacitors.

The operation initiation current dissipation can be changed at the RSL pin.

Also, the output load can be selected, as a piezoelectric buzzer, a transformer coupled speaker, or other similar devices.

●Applications

Telephones, multi-function telephones, telephone answering machines, facsimiles, equipment involving telephones

●Features

- 1) Low current dissipation.
- 2) Withstands up to 40V.
- 3) Operation initiation current dissipation can be changed using RSL pin.
- 4) Pin layout is compatible with the BA8205, BA6565A, and ML8205.

●Block diagram

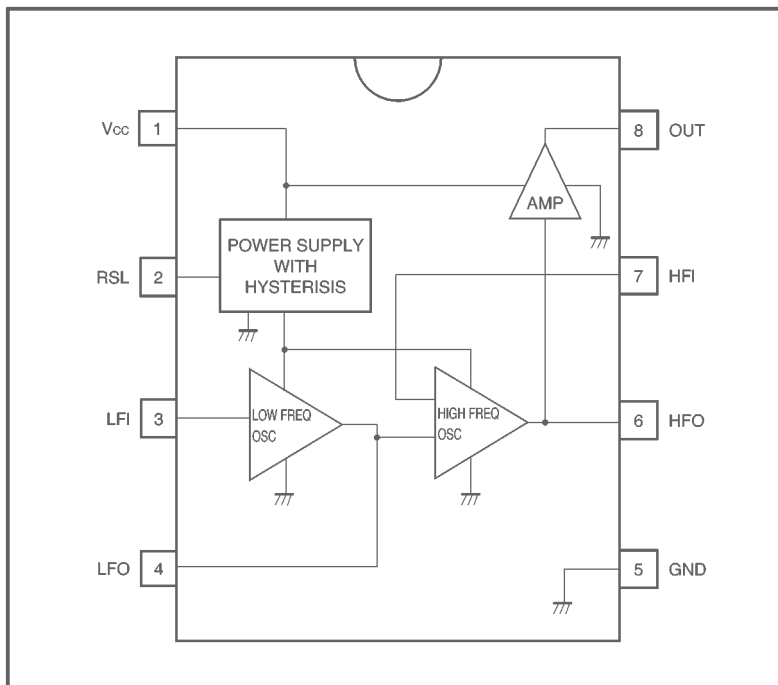

● Absolute maximum ratings (Ta = 25°C)

Parameter	Symbol	Limits	Unit
Power supply voltage	V _{CC}	40	V
Power dissipation	BA8206	500 *1	mW
	BA8206F	450 *2	
Operating temperature	T _{opr}	-25~+75	°C
Storage temperature	T _{stg}	-55~+125	°C

*1 Reduced by 5mW for each increase in Ta of 1°C over 25°C.

*2 Reduced by 4.5mW for each increase in Ta of 1°C over 25°C.

● Recommended operating conditions (Ta = 25°C)

Parameter	Symbol	Min.	Typ.	Max.	Unit
Power supply voltage	V _{opr}	—	—	38	V

● Electrical characteristics (unless otherwise noted, Ta = 25°C, V_{CC} = 24V)

Parameter	Symbol	Min.	Typ.	Max.	Unit	Conditions	Measurement circuit
Initial supply voltage	V _{SI}	14	16	18	V	*1	Fig.1
Sustained operation supply voltage	V _{SUS}	8.2	9.8	11.2	V	*2	Fig.1
Initial current dissipation	I _{SI}	0.9	1.3	1.7	mA	No load, V _{CC} = V _{SI}	Fig.1
Sustained operation current dissipation	I _{SUS}	0.22	0.4	0.7	mA	No load, V _{CC} = V _{SUS}	Fig.1
Oscillation frequency *3	f _L	9	10	11	Hz	R ₁ =773kΩ, C ₁ =0.1 μF	Fig.2
Oscillation frequency *3	f _{H1}	461	512	563	Hz	R ₂ =595kΩ, C ₂ =0.0022 μF	Fig.2
Oscillation frequency *3	f _{H2}	576	640	703	Hz	R ₂ =595kΩ, C ₂ =0.0022 μF	Fig.2
Output high level voltage	V _{OH}	19.7	22.0	23.5	V	I _{OH} =10mA, pin7=GND	Fig.1
Output low level voltage	V _{OL}	0.5	0.9	1.4	V	I _{OL} =10mA, pin7=6V	Fig.1
Ringer threshold voltage	V _{TR}	—	—	36.0	V _{rms}	R _{SL} =9.1kΩ	Fig.3
Output leakage current	I _{LE}	—	—	1.0	μA		Fig.3

*1 The initial supply voltage is the power supply voltage required for the tone ringer to begin oscillating.

*2 The sustained operation voltage is the power supply voltage required for the tone ringer to continue oscillating.

*3 The oscillation frequency is determined using the following equation.

$$f_L = \frac{1}{1.234 \times R_1 \times C_1} \text{ (Hz)}$$

$$f_{H1} = \frac{1}{1.515 \times R_2 \times C_2} \text{ (Hz)}$$

$$f_{H2} = 1.24 \times f_{H1} \text{ (Hz)}$$

The recommended values for R1 and R2 are 300 kΩ or higher.

The ringer threshold voltage is the AC voltage required for the tone ringer to start ringing through the circuit shown in Fig. 6

● Pin descriptions

Pin No.	Pin name	Name	Function
1	Vcc	Power supply pin	This is the power supply pin for the IC. It is connected to the (\oplus) pin of the diode bridge.
2	RSL	RSL pin	This is used to change the operation initiation current when connected to the GND pin.
3	LFI	Low-frequency time constant connector pin	This is connected to the time constant that determines the oscillation frequency on the warble.
4	LFO		
5	GND	GND pin	This pin has the lowest potential on the IC. It is connected to the (\ominus) pin of the diode bridge.
6	HFO	High-frequency time constant connector pin	This is connected to the time constant that determines the oscillation frequency on the tone side (the audible frequency side).
7	HFI		
8	OUT	Output pin	This is used to connect a piezoelectric buzzer, or to connect a dynamic speaker through a transformer.

● Measurement circuit

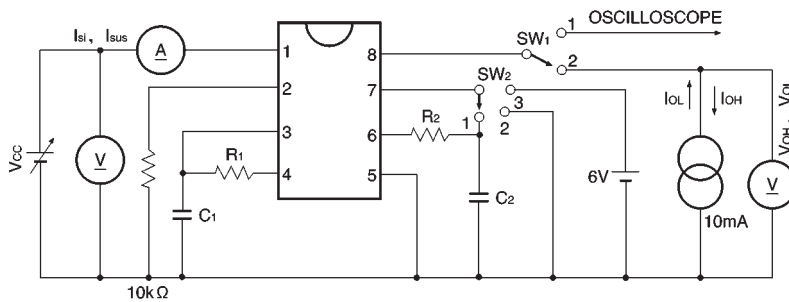

$R_1=773k\Omega$, $C_1=0.1\mu F$

$R_2=595k\Omega$, $C_2=0.0022\mu F$

(Note) The table below shows the statuses for SW₁ and SW₂.

Item	SW ₁	SW ₂
V _{si} , V _{sus}	1	1
I _{si} , I _{sus}	1	1
V _{OH}	2	2
V _{OL}	2	3

Fig. 1

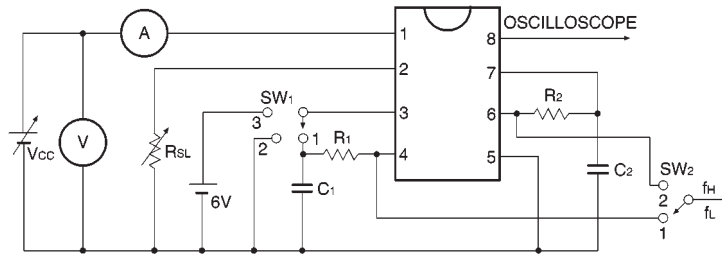

$R_1=773k\Omega$, $C_1=0.1\mu F$

$R_2=595k\Omega$, $C_2=0.0022\mu F$

(Note) The table below shows the statuses for SW₁ and SW₂.

Item	SW ₁	SW ₂
f _L	1	1
f _{H1}	3	2
f _{H2}	2	2

Fig. 2

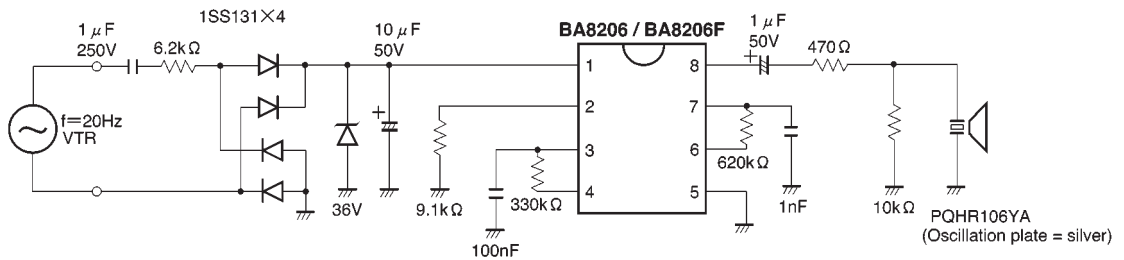

Fig. 3

● Circuit operation

Using the RSL pin

With the BA8206 and BA8206F, the RSL pin can be used to change the initial supply current (I_{si}).

As shown in Figure 4, resistor RSL is connected from the RSL pin (Pin 2) to the GND. The operation initiation current consumption can be changed by changing the value of the resistor RSL.

Figure 5 shows the supply voltage (V_{cc}) - supply current (I_{cc}) characteristics when the value of the resistor RSL is changed.

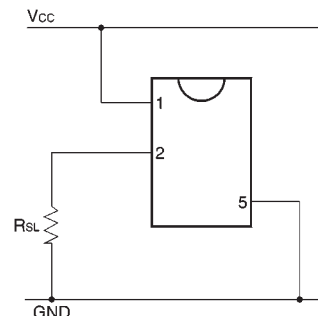

Fig. 4

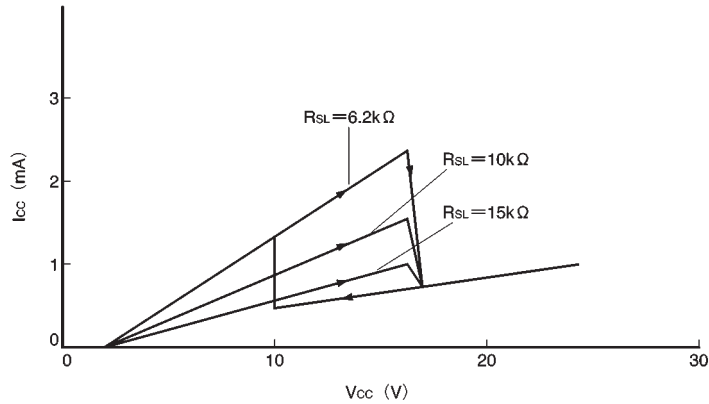

Fig. 5

● Application example

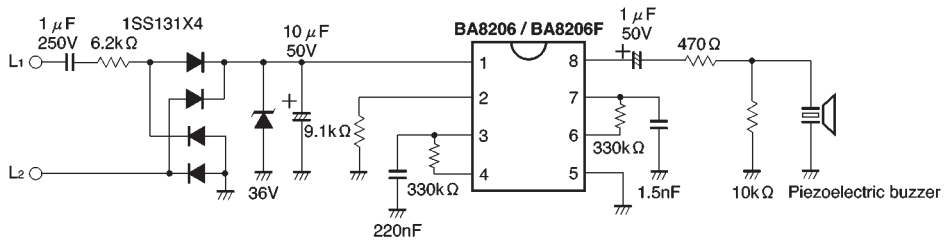

Fig. 6

● Electrical characteristic curves

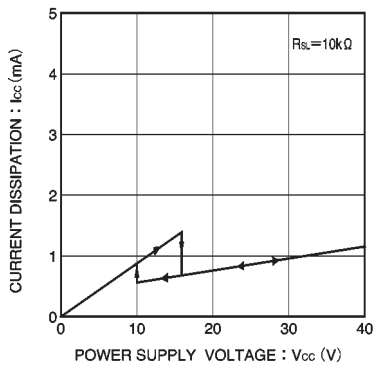

Fig. 7 Current dissipation vs. power supply voltage

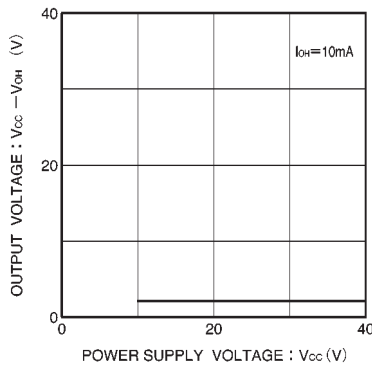

Fig. 8 Output voltage vs. power supply voltage (transistor on source side)

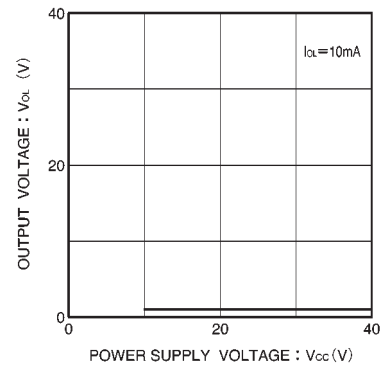
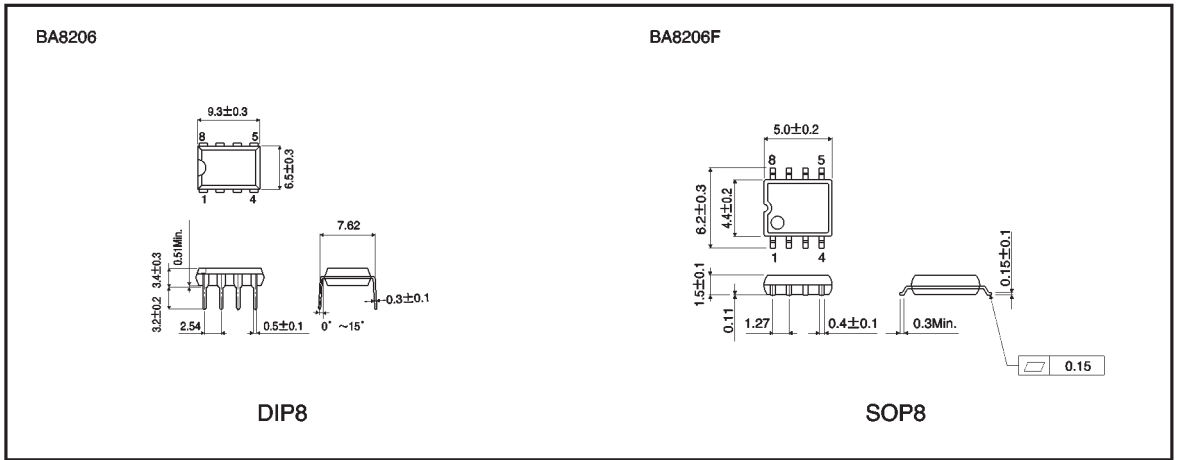



Fig. 9 Output voltage vs. power supply voltage (transistor on sink side)

● External dimensions (Units: mm)







Looking for pricing, stock, or lifecycle information?

Click below to explore more details on WIN SOURCE:

-  [View BA820 on WIN SOURCE](#)
-  [Rohm Semiconductor Information](#)

Optimize Your Supply Chain with WIN SOURCE Solutions

-  Global Sourcing Solution
-  Obsolete Management
-  Cost Control Management
-  Shortage Management
-  Alternative Solution
-  Excess Inventory Management