



**THE DATASHEET OF
7497111611A**



Spezifikation für Freigabe / specification for release

Kunde / customer :
 Artikelnummer / part number : **7497111611A**
 Bezeichnung : **LAN-Übertrager WE-RJ45LAN 10/100/1000 BaseT + USB**
 description : **LAN-Transformer WE-RJ45LAN 10/100/1000 BaseT + USB**



DATUM / DATE : 2018-07-24

A Mechanische Abmessungen / dimensions :

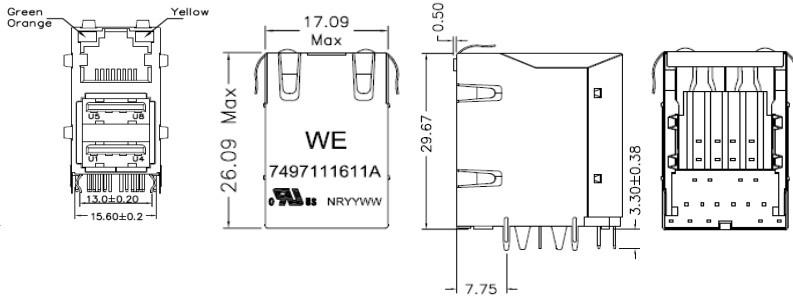

B Lötpad / soldering spec. :

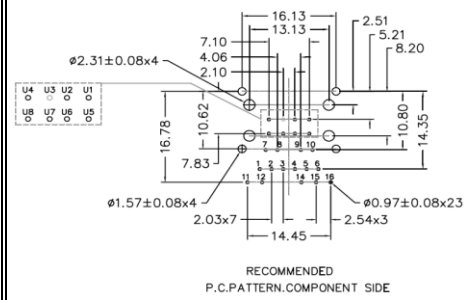

C Elektrische Eigenschaften / electrical properties :

Eigenschaften / properties	Testbedingungen / test conditions		Wert / value	Einheit / unit	tol.
Induktivität / Inductance	100kHz / 100mV @ 8mA DC-Bias	OCL	350	µH	min.
Übersetzungsverhältnis / Turns ratio	100kHz / 100mV	TR	1 : 1		3%
Insertion Loss	1-100MHz	IL	-1,0	dB	max.
Return Loss	1-30MHz @ 100Ω	RL	-16	dB	min.
	30-60MHz @ 100Ω		-13,5		
	60-80MHz @ 100Ω		-12		
	80-100MHz @ 100Ω		-10		
Common Mode Rejection	1-100MHz	CCMR	-30	dB	min.
	100-200MHz		-15		
Crosstalk	1-100MHz	CT	-27	dB	min.

D Prüfgeräte / test equipment :

HP4395A

E Testbedingungen / test conditions :

Luftfeuchtigkeit / humidity: 33%
 Umgebungstemperatur / temperature: +25°C

F Werkstoffe & Zulassungen / material & approvals :

Basismaterial / base material: Ferrit / ferrite
 Draht / wire: UEW/Y 155°C
 Kontaktmaterial/ contact plating: 100% tin w. nickel underplating
 30µ"gold plating on contact area
 Gehäuse / housing: Thermoplastic UL-94V0
 LED: 1.8-2.8V/ 20mA
 Shield: 50µ" nickel over 0.01" cooper alloy

G Eigenschaften / general specifications :

Betriebstemp. / operating temperature: -40°C - + 85°C
 Hochspannungsprüfung / Hipot test: 1500Vrms 1min.
 Geeignet für 1000BaseT-Anwendungen gemäß IEEE 802.3ab /
 Compliant with IEEE 802.3ab for 1000BaseT

Freigabe erteilt / general release:	Kunde / customer		
Datum / date	Unterschrift / signature		
Geprüft / checked	Würth Elektronik		
	Mle	Revision 03	2018-07-24
	JaB	Revision 02	2015-09-18
	KSc	Revision 01	2010-10-27
	KSC	Revision 00	2010-02-12
Kontrolliert / approved		Name	Änderung / modification
		Datum / date	

Würth Elektronik eiSos GmbH & Co.KG

D-74638 Waldenburg · Max-Eyth-Straße 1 - 3 · Germany · Telefon (+49) (0) 7942 - 945 - 0 · Telefax (+49) (0) 7942 - 945 - 400
 http://www.we-online.com

Spezifikation für Freigabe / specification for release

Kunde / customer :

Artikelnummer / part number :

7497111611A



Bezeichnung : LAN-Übertrager WE-RJ45LAN 10/100/1000 BaseT + USB

description : LAN-Transformer WE-RJ45LAN 10/100/1000 BaseT + USB

DATUM / DATE : 2018-07-24

H Schaltbild / Schematics :

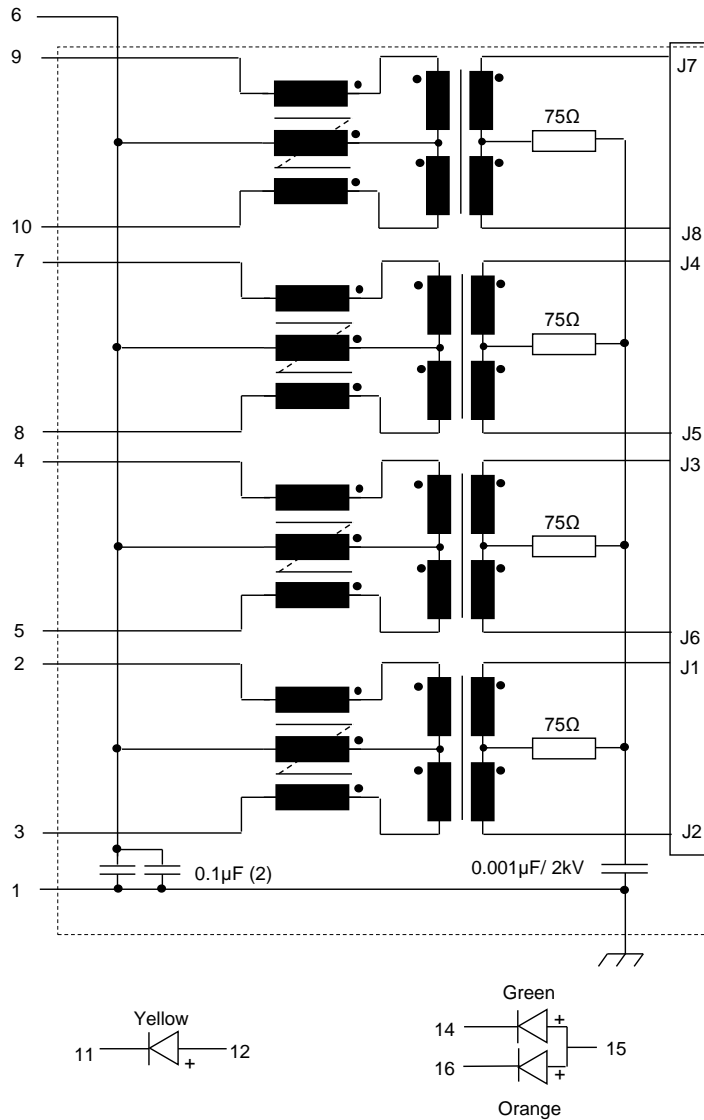

Freigabe erteilt / general release:	Kunde / customer			
.....			
Datum / date	Unterschrift / signature	Mle	Revision 03	2018-07-24
.....	Würth Elektronik	JaB	Revision 02	2015-09-18
.....	KSc	Revision 01	2010-10-27
Geprüft / checked	Kontrolliert / approved	KSC	Revision 00	2010-02-12
.....	Name	Änderung / modification	Datum / date

Würth Elektronik eiSos GmbH & Co.KG

D-74638 Waldenburg · Max-Eyth-Straße 1 - 3 · Germany · Telefon (+49) (0) 7942 - 945 - 0 · Telefax (+49) (0) 7942 - 945 - 400
<http://www.we-online.com>

Spezifikation für Freigabe / specification for release

Kunde / customer :
 Artikelnummer / part number : **7497111611A**
 Bezeichnung : **LAN-Übertrager WE-RJ45LAN 10/100/1000 BaseT + USB**
 description : **LAN-Transformer WE-RJ45LAN 10/100/1000 BaseT + USB**



DATUM / DATE : 2018-07-24

I Verpackungsspezifikation / package specification :

PACKAGING(Tube)

Tube

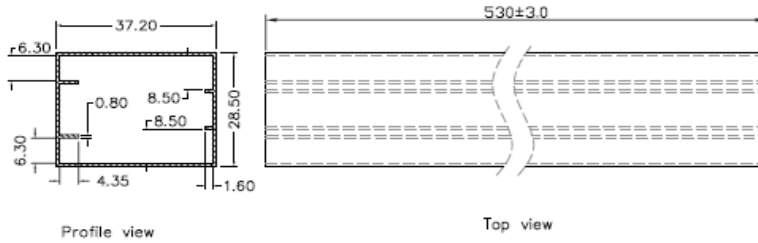

Carton

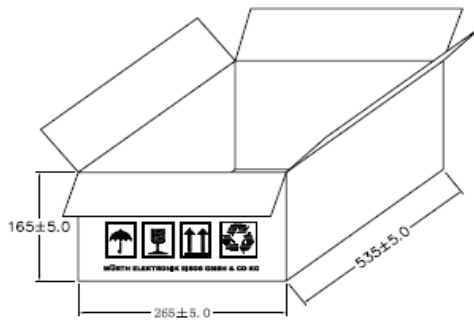

PACKING QUANTITY:

29pcs Finished Goods / Tube
 30pcs Tube (870pcs Finished Goods) / Carton

Freigabe erteilt / general release:	Kunde / customer			
.....			
Datum / date	Unterschrift / signature	Mle	Revision 03	2018-07-24
.....	Würth Elektronik	JaB	Revision 02	2015-09-18
.....	KSc	Revision 01	2010-10-27
Geprüft / checked	Kontrolliert / approved	KSC	Revision 00	2010-02-12
		Name	Änderung / modification	Datum / date



This electronic component has been designed and developed for usage in general electronic equipment. Before incorporating this component into any equipment where higher safety and reliability is especially required or if there is the possibility of direct damage or injury to human body, for example in the range of aerospace, aviation, nuclear control, submarine, transportation, (automotive control, train control, ship control), transportation signal, disaster prevention, medical, public information network etc, Würth Elektronik eiSos GmbH must be informed before the design-in stage. In addition, sufficient reliability evaluation checks for safety must be performed on every electronic component which is used in electrical circuits that require high safety and reliability functions or performance.

Würth Elektronik eiSos GmbH & Co.KG







D-74638 Waldenburg · Max-Eyth-Straße 1 - 3 · Germany · Telefon (+49) (0) 7942 - 945 - 0 · Telefax (+49) (0) 7942 - 945 - 400
<http://www.we-online.com>

Looking for pricing, stock, or lifecycle information?

Click below to explore more details on WIN SOURCE:

-  [View 7497111611A on WIN SOURCE](#)
-  [Wurth Electronics Inc Information](#)

Optimize Your Supply Chain with WIN SOURCE Solutions

-  Global Sourcing Solution
-  Obsolete Management
-  Cost Control Management
-  Shortage Management
-  Alternative Solution
-  Excess Inventory Management