



THE DATASHEET OF RAC20-48SK



Features

Regulated Converter

- Wide input range 85-264VAC / 85-305VAC
- Standby mode optimized PSU (ENER Lot 6)
- Operating Altitude up to 5000m
- Operating temperature range: -40°C to +85°C
- Class II installations (without FG)
- EMC compliant without external components
- No load power consumption 40mW typ.



RAC20-K

20 Watt
2" x 1"
Single and Dual Output

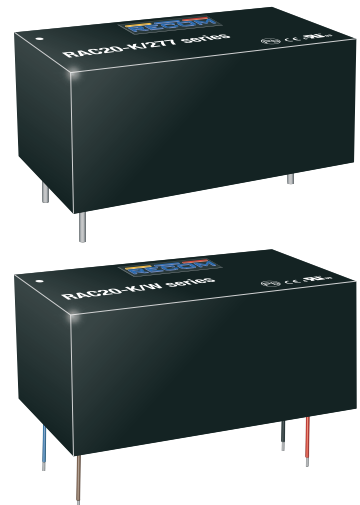

Description

The RAC20-K series are highly efficient PCB-mount power conversion modules with ultra-low energy losses especially in light load conditions, making them a benchmark for always-on and standby mode operations, which are typically coming along with IoT and smart applications. The power supply units cover worldwide mains input range of 85VAC up to 305VAC and come with international safety certifications for industrial, AV and ITE as well as household standards. These AC/DC modules operate in a temperature range of -40°C to +85°C with up to 5000m operating altitude and offer fully protected single or dual outputs as well as EMC class B compliance without the need of any external components in floating connections. Modified versions for OVC III requirements are available on request.

Selection Guide

| Part Number | Input Voltage Range [VAC] | Output Voltage [VDC] | Output Current [mA] | Efficiency typ ⁽¹⁾ [%] | Max. Capacitive Load ⁽²⁾ [µF] |
|-----------------------------|---------------------------|----------------------|---------------------|-----------------------------------|--|
| RAC20-05SK ^(3,4) | 85-264 / 85-305 | 5 | 4000 | 84 | 10000 |
| RAC20-07SK ⁽⁴⁾ | 85-264 | 7 | 2860 | 85 | 15000 |
| RAC20-12SK ^(3,4) | 85-264 / 85-305 | 12 | 1670 | 86 | 8000 |
| RAC20-15SK ^(3,4) | 85-264 / 85-305 | 15 | 1333 | 86 | 1500 |
| RAC20-24SK ^(3,4) | 85-264 / 85-305 | 24 | 830 | 85 | 1000 |
| RAC20-48SK ⁽³⁾ | 85-264 | 48 | 410 | 85 | 330 |
| RAC20-12DK ⁽³⁾ | 85-264 / 85-305 | ±12 | ±833 | 84 | ±1200 |
| RAC20-15DK ⁽³⁾ | 85-264 / 85-305 | ±15 | ±670 | 84 | ±1000 |

Notes:

- Note1: Efficiency is tested at 230VAC input and constant resistive load at +25°C ambient
 Note2: Max Cap Load is tested at nominal input and full resistive load

Model Numbering

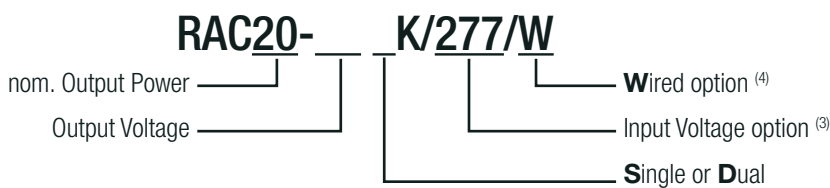

Notes:

- Note3: Add suffix "/277" for wider input voltage range (85-305VAC)
 For detail information refer to "Nominal Input Voltage ^(5,6)"
 without suffix= standard input range 85-264VAC
- Note4: Add suffix „W“ for wired version (single output only, "277/W" combination on request)
 without suffix= standard THT version
 refer to "Model Matrix"

| Model | /277 | /W | /277/W |
|-------|------|------------|------------|
| 5 | x | x | on request |
| 7 | N/A | on request | N/A |
| 12 | x | x | on request |
| 15 | x | x | on request |
| 24 | x | x | on request |
| 48 | N/A | x | on request |
| 12D | x | N/A | N/A |
| 15D | x | N/A | N/A |

x = standard portfolio / on request = MOQ may apply on project base / N/A= not available

YOU MAY ALSO LIKE
 Please consider this alternatives:

RACM30-K/277

RAC20E-K/277

- IEC/EN62368-1 certified
- UL62368-1 certified
- CAN/CSA-C22.2 No. 62368-1-14 certified
- IEC60335-1 5th Ed. certified
- IEC/EN60335-1 certified
- IEC/EN61558-1 certified
- IEC/EN61558-2-16 certified
- IEC/EN61204-3 compliant
- EN55032/14 compliant
- EN55024 compliant
- CB Report

Specifications (measured @ Ta= 25°C, nom. Vin, full load and after warm-up unless otherwise stated)

BASIC CHARACTERISTICS

| Parameter | Condition | | Min. | Typ. | Max. |
|--|--|------------------------------------|--------------------|----------------------|-------------------------|
| Internal Input Filter | | | Pi type | | |
| Nominal Input Voltage ^(5,6) | 50/60Hz | standard version "/277" version | 100VAC | | 240VAC 277VAC |
| Operating Range | standard | 47-63Hz DC | 85VAC 120VDC | | 264VAC 370VDC |
| | "/277" version | 47-63Hz DC | 85VAC 120VDC | | 305VAC 430VDC |
| Input Current | 115VAC 230VAC 277VAC | | | | 450mA 400mA 300mA |
| Inrush Current | cold start at +25°C | 115VAC 230VAC 277VAC | | | 20A 40A 50A |
| No Load Power Consumption | 230VAC | | | 40mW | |
| ErP Lot 6 Standby Mode Conformity (Output Load Capability) | Input Power = 0.5W 1.0W 2.0W | | | | 0.3W 0.7W 1.6W |
| Input Frequency Range | AC Input | | 47Hz | | 63Hz |
| Minimum Load ⁽⁹⁾ | single dual (required for regulation on both outputs) | | 0% | 10% | |
| Power Factor | 115VAC 230VAC 277VAC | | 0.6 0.5 0.45 | | |
| Start-up Time | | | | 150ms | |
| Rise Time | | | | 40ms | |
| Hold-up Time | 115VAC 230VAC 277VAC | | | 12ms 60ms 90ms | |
| Internal Operating Frequency | | | | | 100kHz |
| Output Ripple and Noise ⁽⁷⁾ | 20MHz BW | 5Vout others | | 100mVp-p | 1% of Vout |

Notes:

Note5: The products were submitted for safety files at AC-Input operation

Note6: Refer to "Derating Graph"

Note7: Measurements are made with a 1.0µF MLCC across output (low ESR)

Efficiency vs. Load

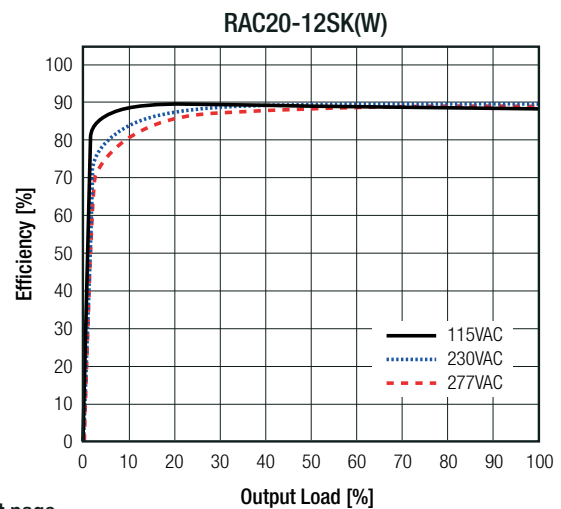
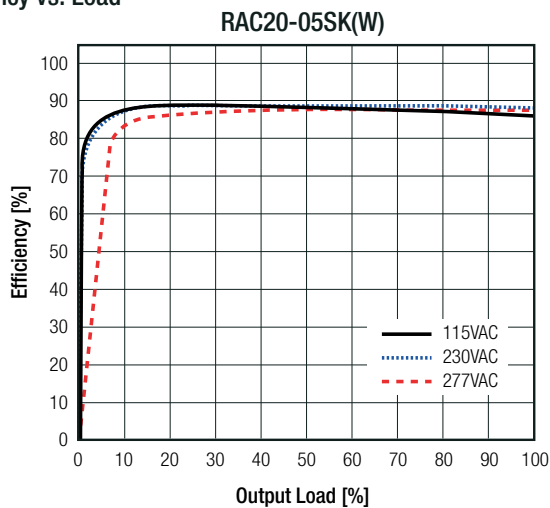

continued on next page

Specifications (measured @ Ta= 25°C, nom. Vin, full load and after warm-up unless otherwise stated)

Efficiency vs. Load

RAC20-15DK

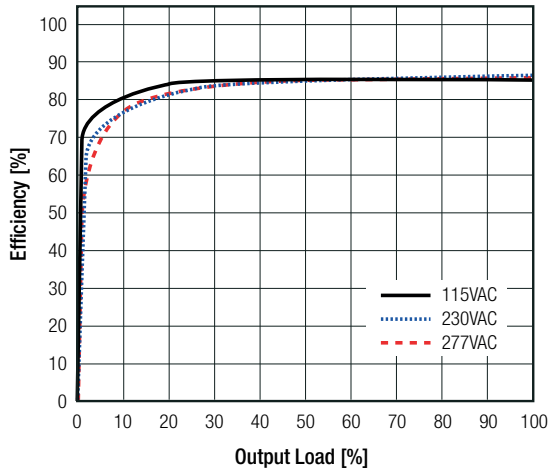

RAC20-24SK(W)

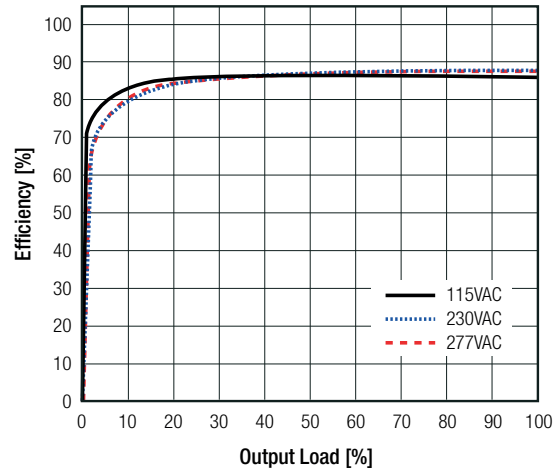

REGULATIONS

| Parameter | Condition | Value |
|--------------------------------|------------------------------------|-------------------------|
| Output Accuracy | | ±2.0% typ. |
| Line Regulation | low line to high line | ±0.5% typ. |
| Load Regulation ⁽⁸⁾ | 10% to 100% load | 2.0% typ. |
| Cross Regulation | dual output only | ±10.0% typ. |
| Transient Response | 25% load step change recovery time | 4.0% max. 500µs typ. |

Notes:

Note8: Operation below 10% load will not harm the converter, but specifications may not be met

Deviation vs. Load

RAC20-05SK(W)

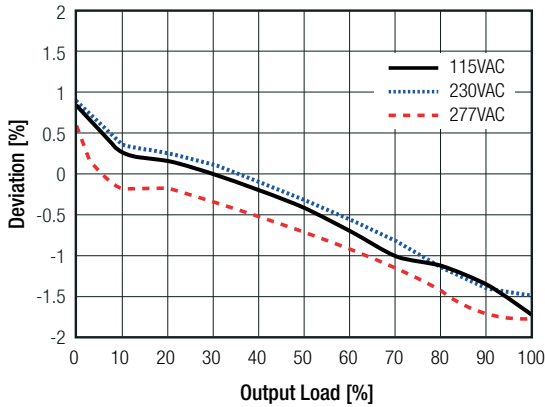

RAC20-12SK(W)

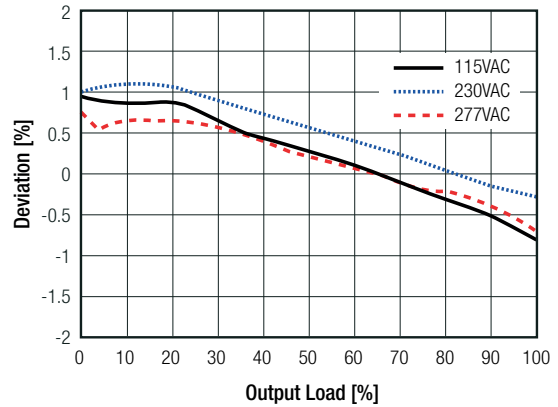

RAC20-15SK(W)

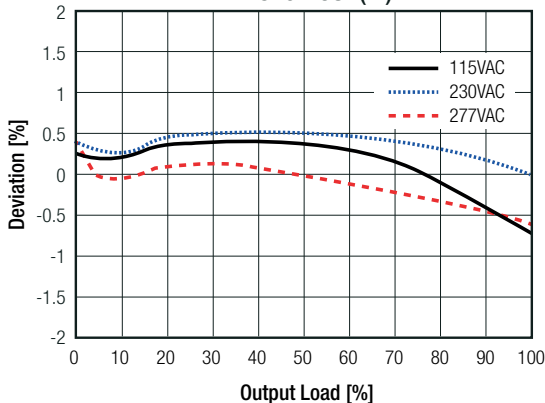

RAC20-24SK(W)

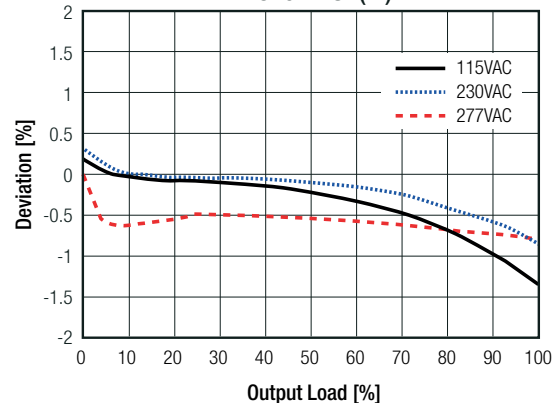

Specifications (measured @ Ta= 25°C, nom. Vin, full load and after warm-up unless otherwise stated)

| PROTECTIONS | | |
|---------------------------------------|-------------|-----------------------------|
| Parameter | Type | Value |
| Input Fuse ⁽⁹⁾ | internal | standard version |
| | | /277 versions |
| Short Circuit Protection (SCP) | below 100mΩ | hiccup, auto recovery |
| Over Voltage Protection (OVP) | | 150% - 195%, latch off mode |
| Over Current Protection (OCP) | | 110% - 130%, hiccup mode |
| Over Voltage Category ⁽¹⁰⁾ | | OVCII |
| Class of Equipment | | Class II |
| Isolation Voltage ⁽¹¹⁾ | I/P to O/P | tested for 1 minute |
| Isolation Resistance | | V _{iso} = 500VDC |
| Isolation Capacitance | | 100pF max. |
| Insulation Grade | | reinforced |
| Leakage Current | | 0.25mA max. |

Notes:

- Note9: Refer to local safety regulations if input over-current protection is also required
 /277 Versions have no fuse integrated, it is recommended to use an external fuse recognized by UL or evaluated by TUV, refer to below schematic
- Note10: For OVC III requirements please contact RECOM tech support for advice
- Note11: For repeat Hi-Pot testing, reduce the time and/or the test voltage

Protection Circuit for /277 Versions

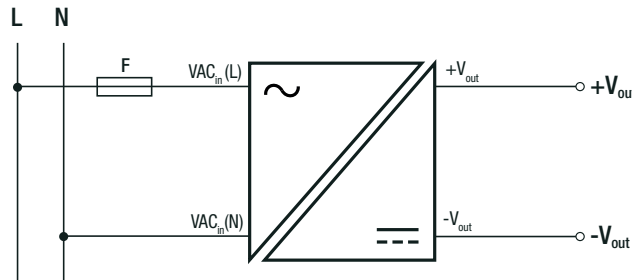

| ENVIRONMENTAL | | |
|------------------------------------|--|---|
| Parameter | Condition | Value |
| Operating Temperature Range | @ natural convection 0.1m/s | full load |
| | | refer to "Derating Graph" |
| Maximum Case Temperature | | +95°C |
| Temperature Coefficient | | 0.05%/K |
| Operating Altitude ⁽¹²⁾ | | 5000m |
| Operating Humidity | non-condensing | 20% - 90% RH max. |
| IP Rating | | IP20 |
| Pollution Degree | | PD2 |
| Vibration | according to MIL-STD-202G according to IEC 60068-2-27 according to IEC 60068-2-65 according to IEC 60068-2-64 | 10-500Hz, 2G 10min./1cycle, period 60min. along x,y,z axes 3 axis, 40 g half sine, 11 ms shock 5-500Hz, 20m/s ² , 1 Oct/min, 15min 10-500Hz; RMS 23,4m/s ² ; 15min |

Notes:

- Note12: Recognized by safety agency for safe operation up to 5000m. High altitude operation may impact the performance and lifetime. Please contact RECOM tech support for advice

continued on next page

Specifications (measured @ Ta= 25°C, nom. Vin, full load and after warm-up unless otherwise stated)

ENVIRONMENTAL

| Parameter | Condition | | Value |
|-----------------|----------------------------------|-------|-------------------------------|
| Design Lifetime | +25°C | | 130 x 10 ³ hours |
| | +55°C | | 16 x 10 ³ hours |
| MTBF | according to MIL-HDBK-217F, G.B. | +25°C | >1196 x 10 ³ hours |
| | | +40°C | >955 x 10 ³ hours |

Derating Graph

(@ Chamber and natural convection 0.1 m/s)

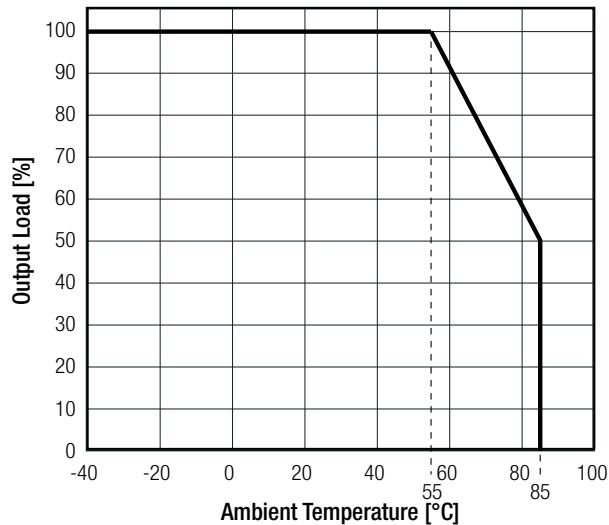

Notes:

Note13: Output power derating for Line-input of less than 90VAC (de-rate linearly from 100% at 90VAC to 90% at 85VAC)

SAFETY AND CERTIFICATIONS

| Certificate Type (Safety) | Report / File Number | Standard |
|--|--------------------------|---|
| Audio/Video, information and communication technology equipment - Safety requirements | E224736 | UL62368-1, 2nd Edition, 2014 CAN/CSA C22.2 Nr. 62368-1-14, 2nd Ed. 2014 |
| Audio/Video, information and communication technology equipment - Safety requirements (CB Scheme) | E491408-A6008-CB-1 | IEC62368-1:2014 2nd Edition |
| Audio/Video, information and communication technology equipment - Safety requirements (LVD) | | EN62368-1:2014 + A11:2017 |
| Household and similar electrical appliances – Safety – Part 1: General requirements (CB Scheme) | 4392216.50 4397422.50 | IEC60335-1:2010 5th Edition + AM1:2013 |
| Household and similar electrical appliances – Safety – Part 1: General requirements | LCS180508046AS | IEC60335-1:2010 + AMD2:2016 + COR1:2016 EN60335-1:2012 + A11:2014 + A13:2017 |
| Safety of power transformers, power supplies, reactors and similar products for supply voltages up to 1100 V (CB Scheme) | 50198090 001 | IEC61558-1:2005 2nd Edition + A1:2009 |
| Safety of power transformers, power supplies, reactors and similar products for supply voltages up to 1100 V | | EN61558-1:2005 + A1:2009 |
| Safety of power transformers, power supplies, reactors and similar products for supply voltages up to 1100 V Part 2: Particular requirements (CB Scheme) | 50198090 001 | IEC61558-2-16:2009 1st Edition + A1:2013 |
| Safety of power transformers, power supplies, reactors and similar products for supply voltages up to 1100 V Part 2: Particular requirements | | EN61558-2-16:2009 + A1:2013 |

continued on next page

Specifications (measured @ Ta= 25°C, nom. Vin, full load and after warm-up unless otherwise stated)

| Certificate Type (Safety) | Report / File Number | Standard |
|---|--|---|
| Safety requirements for power electronic converter systems and equipment - Part 1: General (CB Scheme) | CN21R4QC001 | IEC62477-1:2012 + A1:2016, 1st Edition |
| Safety requirements for power electronic converter systems and equipment - Part 1: General (LVD) | | EN62477-1:2012 + A11:2014 + A1:2017 |
| EAC | RU-AT.03.67361 | TP TC 004/2011 |
| RoHS2 | | RoHS-2011/65/EU + AM-2015/863 |
| EMC Compliance | Condition | Standard / Criterion |
| Low voltage power supplies, d.c. output Part 3: Electromagnetic compatibility (EMC) | | IEC/EN61204-3:2018, Class B |
| Electromagnetic compatibility of multimedia equipment - Emission requirements | without external filter | EN55032:2015, Class B |
| Electromagnetic compatibility of household appliances, electric tools and similar apparatus - Emission Requirements | | EN55014-1:2006 + A2:2011 |
| Information technology equipment - Immunity characters - Limits and methods of measurement | | EN55024:2010 + A1:2015 |
| Electromagnetic compatibility of household appliances, electric tools and similar apparatus - Immunity Requirements | | EN55014-2:2015 |
| ESD Electrostatic discharge immunity test | Air ±8kV, Contact ±4kV | EN61000-4-2:2009, Criteria B |
| Radiated, radio-frequency, electromagnetic field immunity test | 80MHz - 6GHz: 10V/m 1.4GHz - 2GHz: 3V/m 2.0GHz - 2.7GHz: 1V/m | EN61000-4-3:2006 + A1:2008, Criteria A |
| Fast Transient and Burst Immunity | AC Port: ±2.0kV DC Port: ±2.0kV | EN61000-4-4:2012, Criteria B |
| Surge Immunity | AC Port: L-N ±1.0kV DC Port: ±0.5kV | EN61000-4-5:2014 + A1:2017, Criteria B |
| Immunity to conducted disturbances, induced by radio-frequency fields | AC Port: 10V DC Port: 10V | EN61000-4-6:2014, Criteria A |
| Power Magnetic Field Immunity | 50Hz, 30A/m | EN61000-4-8:2010, Criteria A |
| Voltage Dips and Interruptions | Voltage Dips 20% Voltage Dips 30% Voltage Dips 60% Voltage Dips 100% Voltage Interruptions > 95% | EN61000-4-11:2004 + A1:2017, Criteria C EN61000-4-11:2004 + A1:2017, Criteria C EN61000-4-11:2004 + A1:2017, Criteria C EN61000-4-11:2004 + A1:2017, Criteria B EN61000-4-11:2004 + A1:2017, Criteria C |
| Limits of Voltage Fluctuations & Flicker | | EN61000-3-3:2013 |
| Limitations on the amount of electromagnetic interference allowed from digital and electronic devices | | FCC 47 CFR Part 15 Subpart B, Class B |
| American National Standard for Methods of Measurement of Radio-Noise Emissions from Low-Voltage Electrical and Electronic Equipment in the Range of 9 kHz to 40 GHz | | ANSI C63.4-2014, Class B |
| <p>Notes:</p> <p>Note14: If output is connected to GND, please contact RECOM tech support for advice</p> | | |

| DIMENSION AND PHYSICAL CHARACTERISTICS | | |
|--|-----------|--------------------------|
| Parameter | Type | Value |
| Material | case | black plastic, (UL94V-0) |
| | potting | silicone, (UL94V-0) |
| | PCB | FR4, (UL94V-0) |
| | baseplate | black plastic, (UL94V-0) |
| Dimension (LxWxH) | | 52.5 x 27.4 x 23.0mm |
| Weight | THT | 60g typ. |
| | wired | 65g typ. |
| continued on next page | | |

Specifications (measured @ Ta= 25°C, nom. Vin, full load and after warm-up unless otherwise stated)

Dimension Drawing (mm)

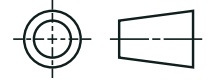
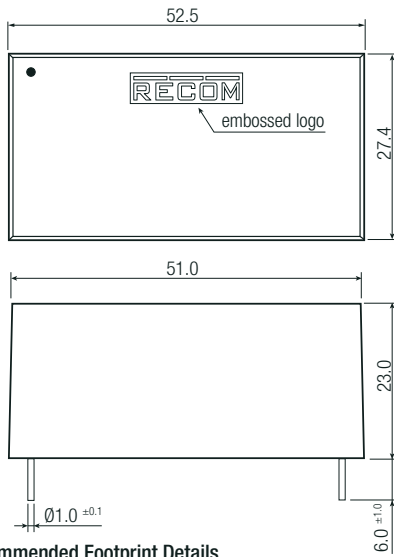

Pinning information

| Pin # | Single | Dual |
|-------|------------|------------|
| 1 | VAC in (N) | VAC in (N) |
| 2 | VAC in (L) | VAC in (L) |
| 3 | no pin | -Vout |
| 4 | -Vout | Com |
| 5 | +Vout | +Vout |

Tolerance: xx.x= ±0.5mm
xx.xx= ±0.25mm

Recommended Footprint Details

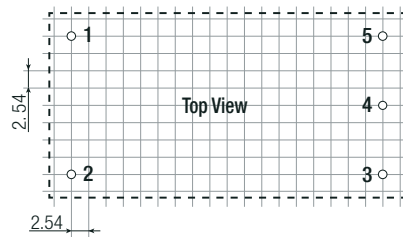
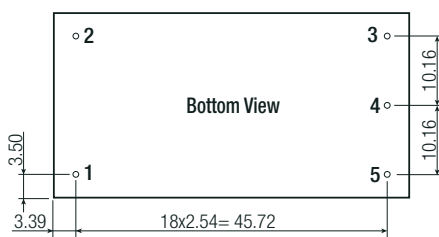

Dimension Drawing Single Wired (mm)

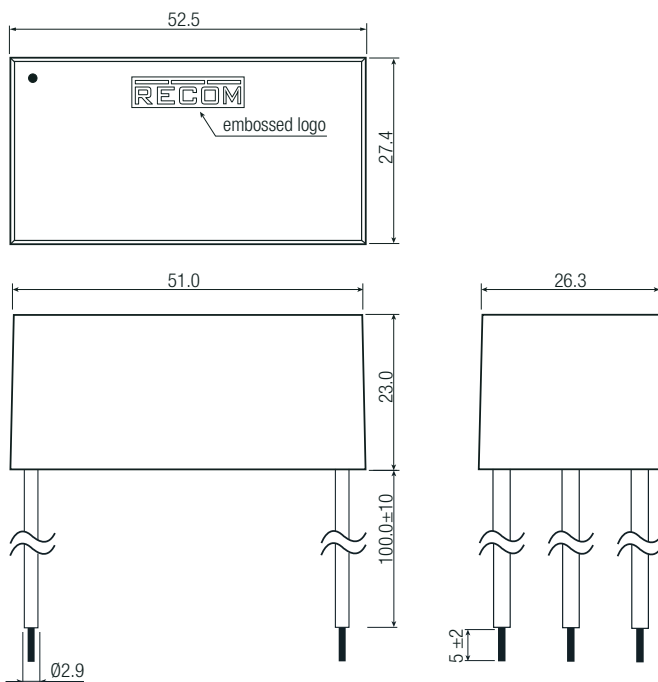

Wired information

| # | Function | Wire color | Type | AWG |
|---|------------|------------|---------|-----|
| 1 | VAC in (N) | blue | UL-1015 | 18 |
| 2 | VAC in (L) | brown | UL-1015 | 18 |
| 4 | -Vout | black | UL-1015 | 18 |
| 5 | +Vout | red | UL-1015 | 18 |

Tolerance: xx.x= ±0.5mm
xx.xx= ±0.25mm

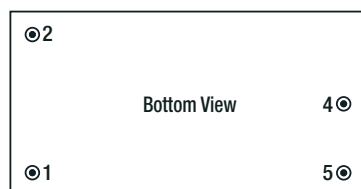



Specifications (measured @ Ta= 25°C, nom. Vin, full load and after warm-up unless otherwise stated)

| PACKAGING INFORMATION | | | |
|-----------------------------|----------------|--------------|------------------------|
| Parameter | Type | | Value |
| Packaging Dimension (LxWxH) | pin wired | tube tray | 490.0 x 56.0 x 40.0mm |
| | | | 488.0 x 202.0 x 47.0mm |
| Packaging Quantity | tube | | 15pcs |
| | tray | | 20pcs |
| Storage Temperature Range | | | -40°C to +85°C |
| Storage Humidity | non-condensing | | 20% to 90% RH max. |

The product information and specifications may be subject to changes even without prior written notice. The product has been designed for various applications; its suitability lies in the responsibility of each customer. The products are not authorized for use in safety-critical applications without RECOM's explicit written consent. A safety-critical application is an application where a failure may reasonably be expected to endanger or cause loss of life, inflict bodily harm or damage property. The applicant shall indemnify and hold harmless RECOM, its affiliated companies and its representatives against any damage claims in connection with the unauthorized use of RECOM products in such safety-critical applications.

Looking for pricing, stock, or lifecycle information?

Click below to explore more details on WIN SOURCE:

-  [View RAC20-48SK on WIN SOURCE](#)
-  [Recom Power Information](#)

Optimize Your Supply Chain with WIN SOURCE Solutions

-  Global Sourcing Solution
-  Obsolete Management
-  Cost Control Management
-  Shortage Management
-  Alternative Solution
-  Excess Inventory Management