



**THE DATASHEET OF
PKM4510EPI**



36-75 Vdc DC/DC converter

Output up to 20 A/50 W

Contents

Product Program	2
Quality Statement	2
Limitation of Liability	2
Mechanical Information	3
Mechanical Information HS-Option	4
Absolute Maximum Ratings	5
Input	5
Safety Specification	6
Product Qualification Specification	7
PKM 4218LE PI - 1.2 V Data	8
PKM 4318HE PI - 1.5 V Data	11
PKM 4318GE PI - 1.8 V Data	14
PKM 4319E PI - 2.5 V Data	17
PKM 4510E PI - 3.3 V Data	20
PKM 4511E PI - 5.0 V Data	23
PKM 4513E PI - 12 V Data	26
PKM 4515E PI - 15 V Data	29
EMC Specification	32
Operating Information	33
Thermal Consideration	35
Soldering Information	36
Delivery Package Information	36
Compatibility with RoHS requirements	36
Reliability	36

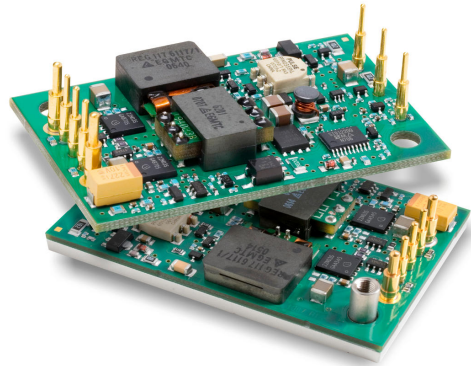

Key Features

- Industry standard Quarter-brick
57.9 x 36.8 x 8.5 mm (2.28 x 1.45 x 0.33 in)
- High efficiency, typ. 90 % at 3.3 Vout half load
- 1500 Vdc input to output isolation, meets isolation requirements equivalent to basic insulation according to IEC/EN/UL 60950
- More than 7.0 million hours predicted MTBF at +40 °C ambient temperature

The PKM 4000E series of high efficiency DC/DC converters are designed to provide high quality on-board power solutions in distributed power architectures used in Internetworking equipment in wireless and wired communications applications. The PKM 4000E series has industry standard quarter brick footprint and pin-out and is only 8.5 mm (0.33 in) high. This makes it extremely well suited for narrow board pitch applications with board spacing down to 15 mm (0.6 in). The PKM 4000E series uses patented synchronous rectification technology and achieves an efficiency up to 90% at full load. Flex's PKM 4000E series addresses both the industrial and the emerging telecom market for applications in the multi-

service network by specifying the input voltage range in accordance with ETSI specifications. Included as standard features are output over-voltage protection, input under-voltage protection, over temperature protection, soft-start, output short circuit protection, remote sense, remote control, and output voltage adjust function. These converters are designed to meet high reliability requirements and are manufactured in highly automated manufacturing lines and meet world-class quality levels.

Flex is an ISO 9001/14001 certified supplier.

Product Program

V _I	V _O /I _O max	P _O max	Ordering No.	Comment
	Output 1			
48/60	1.2 V/20 A	24W	PKM 4218LE PI	
48/60	1.5 V/20 A	30W	PKM 4318HE PI	
48/60	1.8 V/20 A	36W	PKM 4318GE PI	
48/60	2.5V/15 A	37.5W	PKM 4319E PI	
48/60	3.3 V/15 A	50W	PKM 4510E PI	
48/60	5.0 V/10 A	50W	PKM 4511E PI	
48/60	12 V/4.2 A	50W	PKM 4513E PI	
48/60	15 V/3.3 A	50W	PKM 4515E PI	
Option		Suffix	Example	
Positive Remote Control logic		P	PKM 4510E PIP	
Heatsink		HS	PKM 4510E PIHS	
Lead length 3.69 mm (0.145 in)		LA	PKM 4510E PILA	

Note: As an example a positive logic, heatsink, short pin product would be PKM 4510E PIPHSLA

Quality Statement

The PKM 4000E DC/DC converters are designed and manufactured in an industrial environment where quality systems and methods like ISO 9000, 6 σ (sigma), and SPC are intensively in use to boost the continuous improvements strategy. Infant mortality or early failures in the products are screened out and they are subjected to an ATE-based final test. Conservative design rules, design reviews and product qualifications, plus the high competence of an engaged work force, contribute to the high quality of our products.

Limitation of Liability

Flex does not make any other warranties, expressed or implied including any warranty of merchantability or fitness for a particular purpose (including, but not limited to, use in life support applications, where malfunctions of product can cause injury to a person's health or life).

Mechanical Information

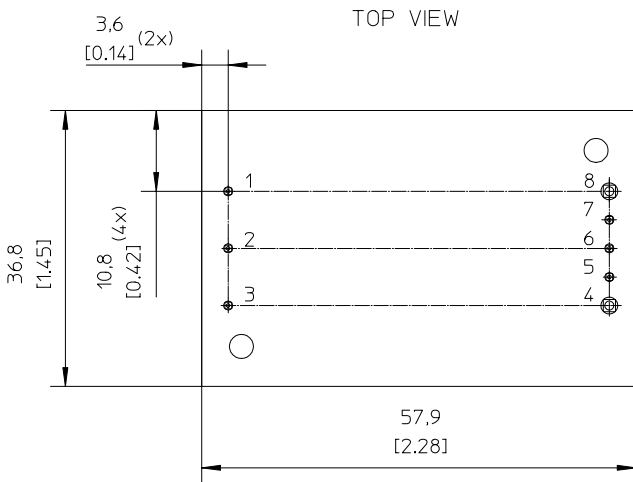
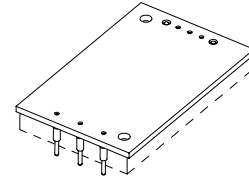
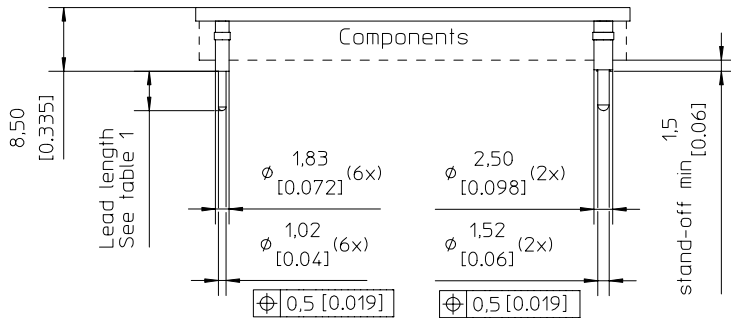

Connections

Pin	Designation	Function
1	+In	Positive input
2	RC	Remote control
3	-In	Negative input
4	-Out	Negative output
5	-Sen	Negative remote sense
6	Vadj	Output voltage adjust
7	+Sen	Positive remote sense
8	+Out	Positive output

Recommended footprint - TOP VIEW

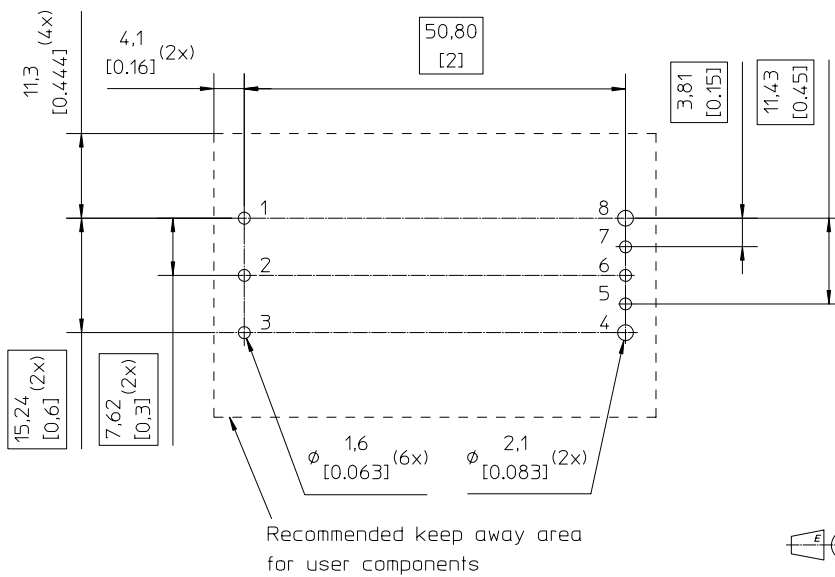

Table 1

Pin option	Lead Length
Standard	5,25 [0,207]
LA	3,69 [0,145]

Weight: Typical 20g

Pins:

Material: Brass

Plating: 0,1µm Gold over 2µm Nickel

All dimensions are in mm [inches]

Tolerances unless specified

x.x±0,5[0,02]

x.xx±0,25[0,01]

Not applied on the recommended footprint

Mechanical Information HS-Option

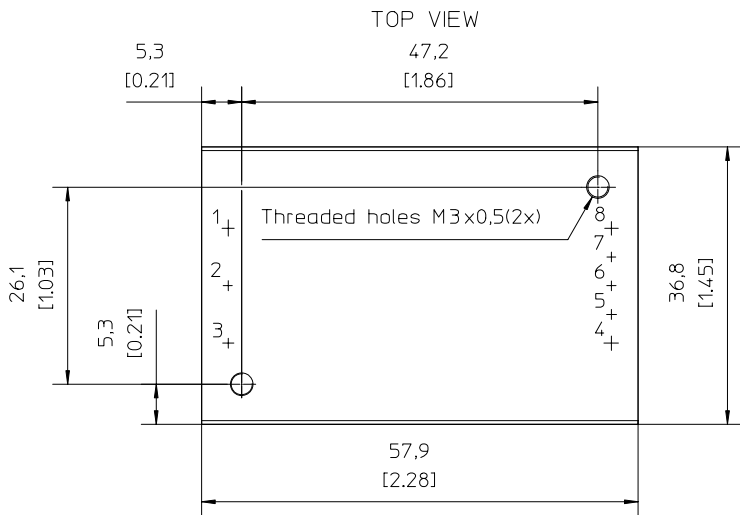
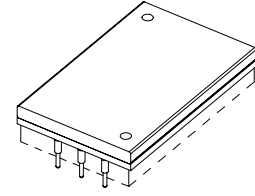
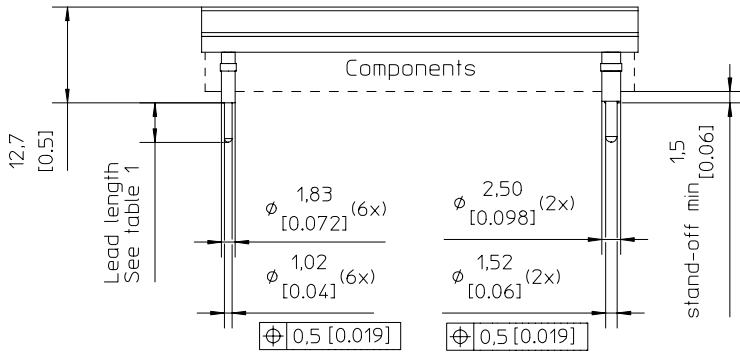

Connections

Pin	Designation	Function
1	+In	Positive input
2	RC	Remote control
3	-In	Negative input
4	-Out	Negative output
5	-Sen	Negative remote sense
6	Vadj	Output voltage adjust
7	+Sen	Positive remote sense
8	+Out	Positive output

Recommended footprint - TOP VIEW

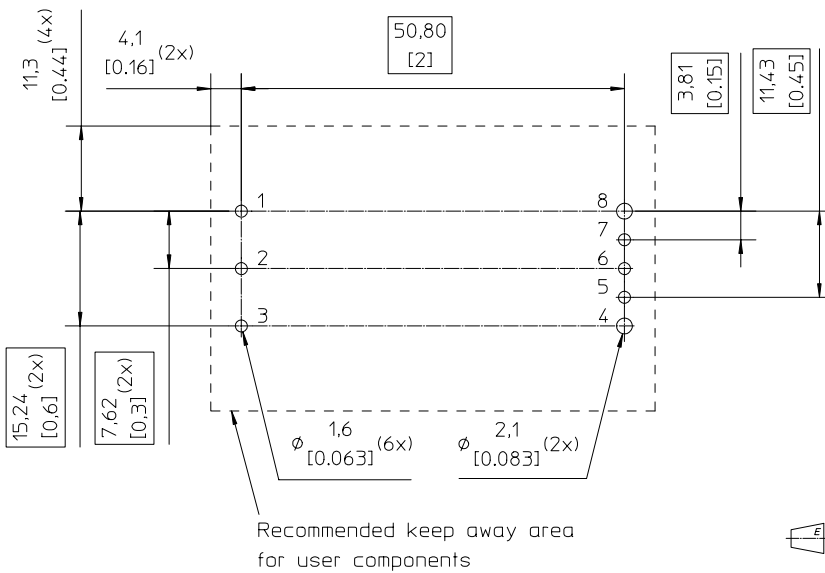

Table 1

Pin option	Lead Length
Standard	5,25 [0,207]
LA	3,69 [0,145]

Weight: Typical 43g

Case: Aluminium base plate.
For screw attachment, apply mounting torque of max 0.44 Nm [3.9 IN-LBS]

Pins:
Material: Brass
Plating: 0,1µm Gold over 2µm Nickel

All dimensions are in mm [inches]
Tolerances unless specified

x.x±0,5[0.02]

x.xx±0,25[0.01]

Not applied on the recommended footprint

Absolute Maximum Ratings

Characteristics		min	typ	max	Unit
T_C	Maximum Operating Baseplate Temperature (see Thermal Consideration section)	-40		+110	°C
T_S	Storage temperature	-55		+125	°C
V_I	Input voltage	-0.5		+80	Vdc
V_{ISO}	Isolation voltage (input to output test voltage)			1500	Vdc
V_{tr}	Input voltage transient (T_p 100 ms)			100	Vdc
V_{RC}	Negative logic (referenced to -In)			75	Vdc
	Positive logic (referenced to -In)			6	Vdc
V_{adj}	Maximum input	-0.5		$2 \times V_{oi}$	Vdc

Stress in excess of Absolute Maximum Ratings may cause permanent damage. Absolute Maximum Ratings, sometimes referred to as no destruction limits, are normally tested with one parameter at a time exceeding the limits of Output data or Electrical Characteristics. If exposed to stress above these limits, function and performance may degrade in an unspecified manner.

Input $T_{Pcb} < T_{Pcb\ max}$ unless otherwise specified

Characteristics		Conditions	min	typ	max	Unit
V_I	Input voltage range		35		75	Vdc
V_{loff}	Turn-off input voltage	Ramping from higher voltage		30		Vdc
V_{lon}	Turn-on input voltage	Ramping from lower voltage		33.5		Vdc
C_I	Input capacitance			1		μF
P_{li}	Input idling power	$I_o = 0, V_I = 53\ V$		2		W
P_{RC}	Input standby power (turned off with RC)	$V_I = 53\ V, RC$ activated		0.25		W

Fundamental Circuit Diagram

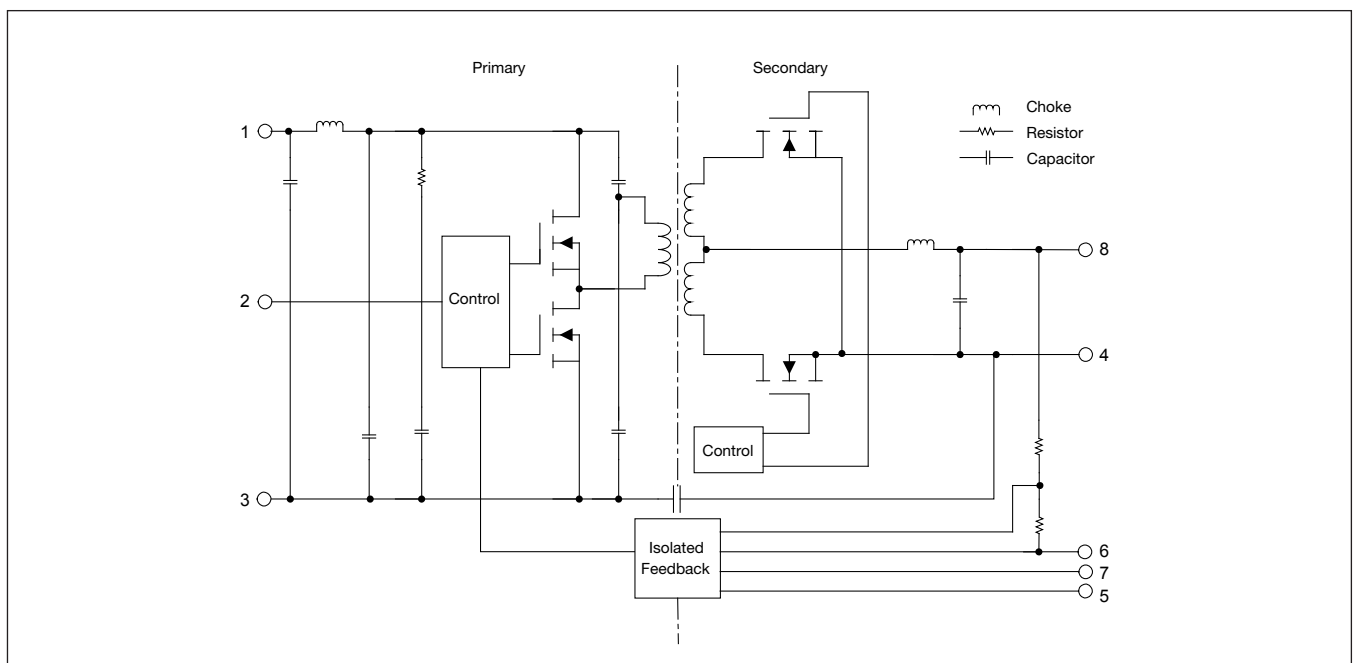

Safety Specification

General information.

Flex DC/DC converters and DC/DC regulators are designed in accordance with safety standards IEC/EN/UL 60 950, *Safety of Information Technology Equipment*.

IEC/EN/UL60950 contains requirements to prevent injury or damage due to the following hazards:

- *Electrical shock*
- *Energy hazards*
- *Fire*
- *Mechanical and heat hazards*
- *Radiation hazards*
- *Chemical hazards*

On-board DC-DC converters are defined as component power supplies. As components they cannot fully comply with the provisions of any Safety requirements without "Conditions of Acceptability". It is the responsibility of the installer to ensure that the final product housing these components complies with the requirements of all applicable Safety standards and Directives for the final product.

Component power supplies for general use should comply with the requirements in IEC60950, EN60950 and UL60950 "Safety of information technology equipment".

There are other more product related standards, e.g. IEC61204-7 "Safety standard for power supplies", IEEE802.3af "Ethernet LAN/MAN Data terminal equipment power", and ETS300132-2 "Power supply interface at the input to telecommunications equipment; part 2: DC", but all of these standards are based on IEC/EN/UL60950 with regards to safety.

Flex DC/DC converters and DC/DC regulators are UL 60 950 recognized and certified in accordance with EN 60 950.

The flammability rating for all construction parts of the products meets UL 94V-0.

The products should be installed in the end-use equipment, in accordance with the requirements of the ultimate application. Normally the output of the DC/DC converter is considered as SELV (Safety Extra Low Voltage) and the input source must be isolated by minimum Double or Reinforced Insulation from the primary circuit (AC mains) in accordance with IEC/EN/UL 60 950.

Isolated DC/DC converters.

It is recommended that a fast blow fuse with a rating twice the maximum input current per selected product be used at the input of each DC/DC converter. If an input filter is used in the circuit the fuse should be placed in front of the input filter.

In the rare event of a component problem in the input filter or in the DC/DC converter that imposes a short circuit on the input source, this fuse will provide the following functions:

- Isolate the faulty DC/DC converter from the input power source so as not to affect the operation of other parts of the system.
- Protect the distribution wiring from excessive current and power loss thus preventing hazardous overheating.

The galvanic isolation is verified in an electric strength test. The test voltage (V_{ISO}) between input and output is 1500 Vdc or 2250 Vdc for 60 seconds (refer to product specification). Leakage current is less than 1 μ A at nominal input voltage.

24 V dc systems.

The input voltage to the DC/DC converter is SELV (Safety Extra Low Voltage) and the output remains SELV under normal and abnormal operating conditions.

48 and 60 V dc systems.

If the input voltage to Flex DC/DC converter is 75 V dc or less, then the output remains SELV (Safety Extra Low Voltage) under normal and abnormal operating conditions.

Single fault testing in the input power supply circuit should be performed with the DC/DC converter connected to demonstrate that the input voltage does not exceed 75 V dc.

If the input power source circuit is a DC power system, the source may be treated as a TNV2 circuit and testing has demonstrated compliance with SELV limits and isolation requirements equivalent to Basic Insulation in accordance with IEC/EN/UL 60 950.

Non-isolated DC/DC regulators.

The input voltage to the DC/DC regulator is SELV (Safety Extra Low Voltage) and the output remains SELV under normal and abnormal operating conditions.

It is recommended that a slow blow fuse with a rating twice the maximum input current per selected product be used at the input of each DC/DC regulator.

Product Qualification Specification

Characteristics			
Random Vibration	IEC 68-2-64 F _h	Frequency Spectral density Duration	10 ... 500 Hz 0.07 g ² /Hz 10 min each direction
Sinusoidal Vibration	IEC 68-2-6 F _c	Frequency Amplitude Acceleration Number of cycles	10 ... 500 Hz 0.75 mm 10 g 10 in each axis
Mechanical shock (half sinus)	IEC 68-2-27 E _a	Peak acceleration Duration Pulse shape	100 g 6 ms half sine
Temperature cycling	IEC 68-2-14 N _a	Temperature Number of cycles	-40 ... +100 °C 300
Heat/Humidity	IEC 68-2-3 C _a	Temperature Humidity Duration	+85 °C 85 % RH 1000 hours
Solder heat stability	IEC 68-2-20 T _b 1A	Temperature, solder Duration	260 °C 10 ...13 s
Resistance to cleaning agents	IEC 68-2-45 XA Method 2	Water Isopropyl alcohol Glycol ether Method	+55 ±5 °C +35 ±5 °C +35 ±5 °C with rubbing
Storage test	IEC 68-2-2 B _a	Temperature Duration	125 °C 1000 h
Cold (in operation)	IEC 68-2-1 A _d	Temperature, T _A Duration	-45 °C 2 h
Operational life test		Duration	1000 h

PKM 4218LE PI Output

$T_{Pcb} = -40...+90\text{ °C}$ and $V_I = 36...75\text{V}$, sense pins connected to output pins unless otherwise specified.

Characteristics		Conditions	Output			Unit
			min	typ	max	
V_{O1}	Output voltage initial setting and accuracy	$I_{Omax}, V_I = 53\text{ V}, T_{Pcb} = 25\text{ °C}$	1.175	1.2	1.225	V
	Output adjust range	$I_{Omax}, V_I = 53\text{ V}, T_{Pcb} = 25\text{ °C}$	1.08		1.32	V
V_O	Output voltage tolerance band	$I_O = (0.1...1.0) \times I_{Omax}$	1.165		1.235	V
	Idling voltage	$I_O = 0$	1.175		1.225	V
	Line regulation	I_{Omax}			5	mV
	Load regulation	$I_O = (0.01...1.0) \times I_{Omax}, V_I = 53\text{ V}$			5	mV
V_{tr}	Load transient voltage deviation	$I_O = (0.1...1.0) \times I_{Omax}, V_I = 53\text{ V},$ load step = $0.5 \times I_{Omax}$		± 100		mV
t_{tr}	Load transient recovery time	$I_O = (0.1...1.0) \times I_{Omax}, V_I = 53\text{ V},$ load step = $0.5 \times I_{Omax}$		100		μs
t_r	Ramp-up time	$I_O = (0.1...1.0) \times I_{Omax}, V_I = 53\text{ V}$ $(0.1...0.9) \times V_{Onom}$		6	10	ms
t_s	Start-up time	$I_O = (0.1...1.0) \times I_{Omax}, V_I = 53\text{ V}$ V_I connection to $0.9 \times V_{Onom}$		9	15	ms
I_O	Output current		0		20	A
P_{Omax}	Max output power	At $V_O = V_{Onom}$	24			W
I_{lim}	Current limit threshold	$T_{Pcb} < T_{Pcbmax}$		26		A
I_{sc}	Short circuit current	$T_{Pcb} = 25\text{ °C}, V_O < 0.5\text{V}$		30		A
V_{Oac}	Output ripple & noise	See ripple and noise, $I_{Omax}, V_{Onom},$		35	60	mV_{p-p}
SVR	Supply voltage rejection (ac)	$T_{Pcb} = 25\text{ °C}, f = 100\text{ Hz}$ sinewave, $1\text{ V}_{pp},$ $V_I = 53\text{ V}$		67		dB
OVP	Over voltage protection	$V_I = 53\text{ V}, I_O = (0.1...1.0) \times I_{Omax}$	1.5		2.5	V

Miscellaneous

Characteristics		Conditions	min	typ	max	Unit
η	Efficiency - 50% load	$T_{Pcb} = +25\text{ °C}, V_I = 48\text{ V}, I_O = 0.5 \times I_{Omax}$		84.5		%
η	Efficiency - 100% load	$T_{Pcb} = +25\text{ °C}, V_I = 48\text{ V}, I_O = I_{Omax}$		83		%
η	Efficiency - 50% load	$T_{Pcb} = +25\text{ °C}, V_I = 53\text{ V}, I_O = 0.5 \times I_{Omax}$		84		%
η	Efficiency - 100% load	$T_{Pcb} = +25\text{ °C}, V_I = 53\text{ V}, I_O = I_{Omax}$	81	84		%
P_d	Power Dissipation	$I_{Omax}, V_I = 53\text{ V}, T_{Pcb} = 25\text{ °C}$		5		W
f_s	Switching frequency			180		kHz

PKM 4218LE PI Typical Characteristics

Efficiency

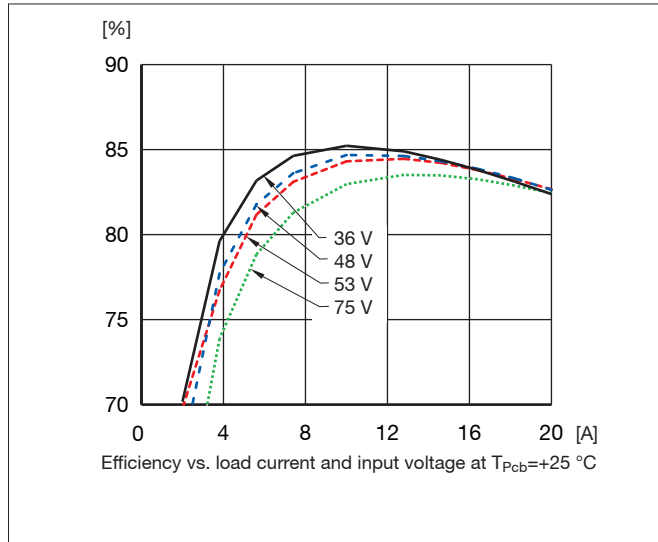

Output Current Derating

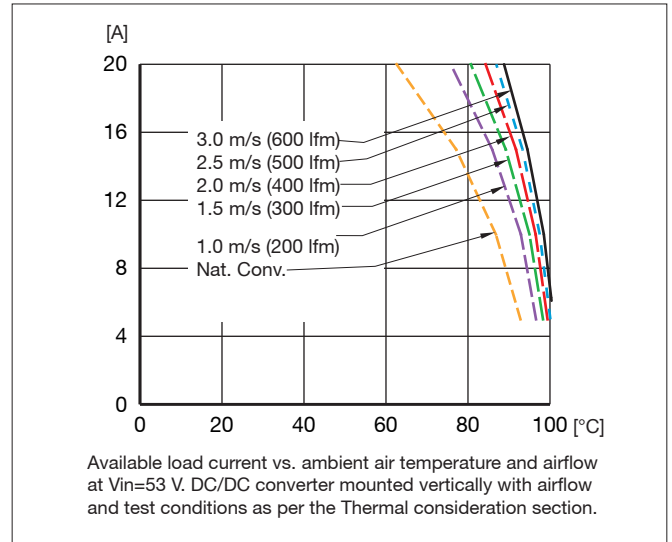

Power Dissipation

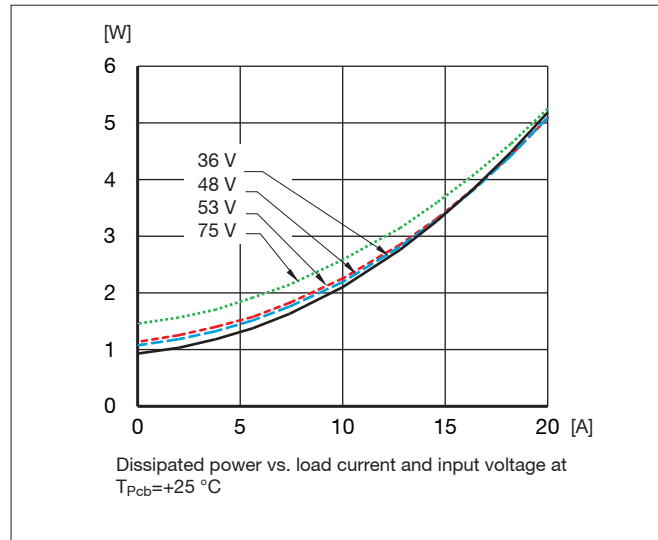

Thermal resistance

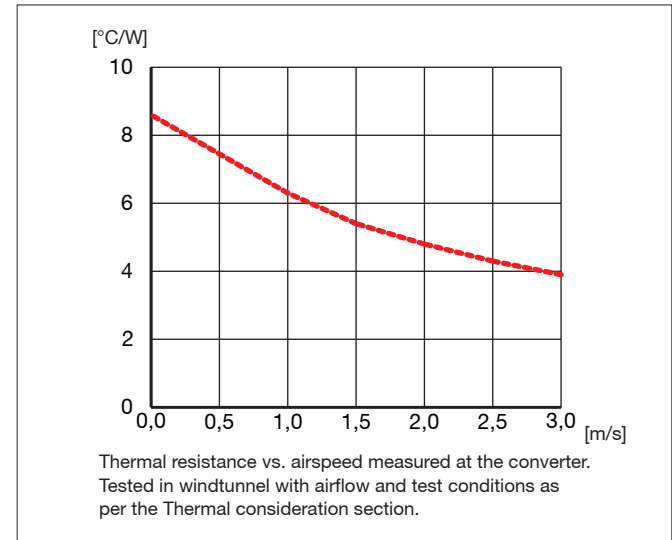

Output Characteristic

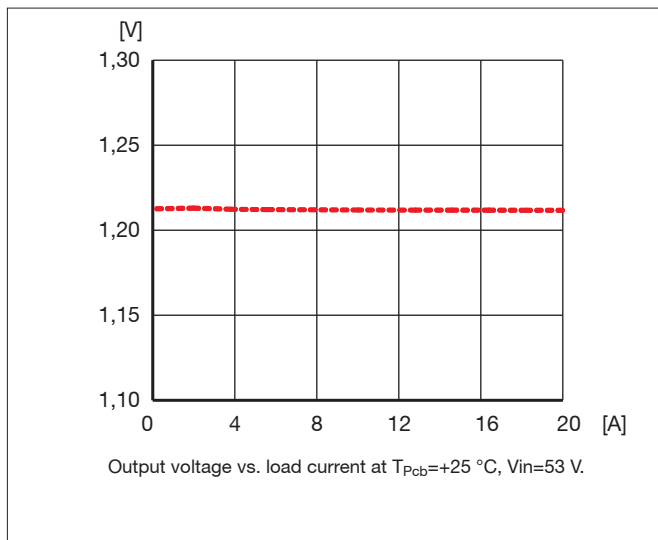

Heatsink (HS) option

The PKM4000E series DC/DC converters can be ordered with a heatsink (HS) option. The heatsink option have approximately 5 °C improved derating compared with the PKM4000E without heatsink. The HS option is intended to be mounted on a cold wall to transfer heat away from the converter.

PKM 4218LE PI Typical Characteristics

Start-Up

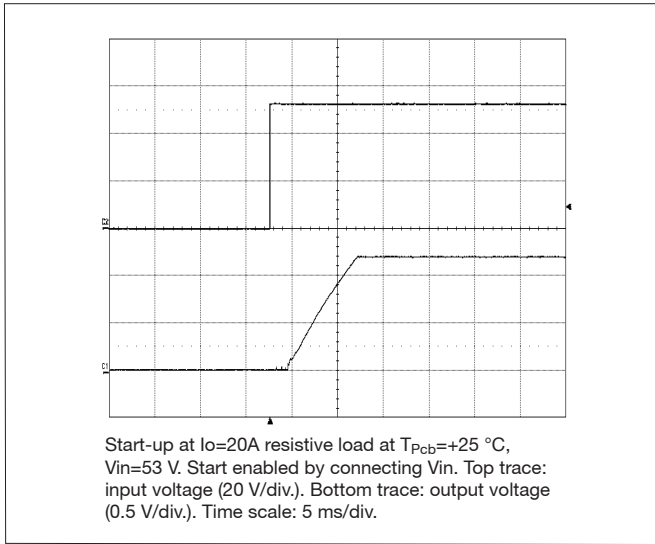

Turn-Off

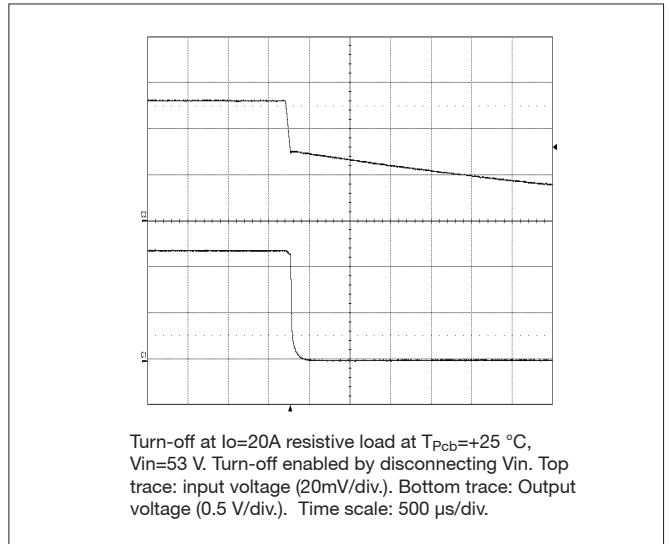

Output Ripple

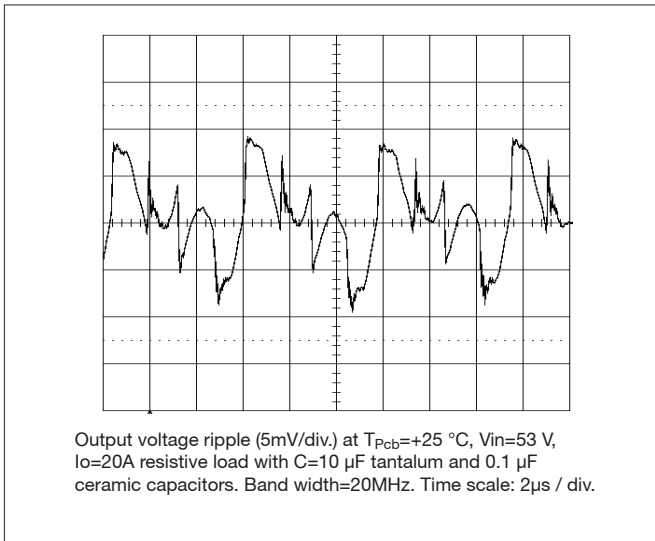

Transient

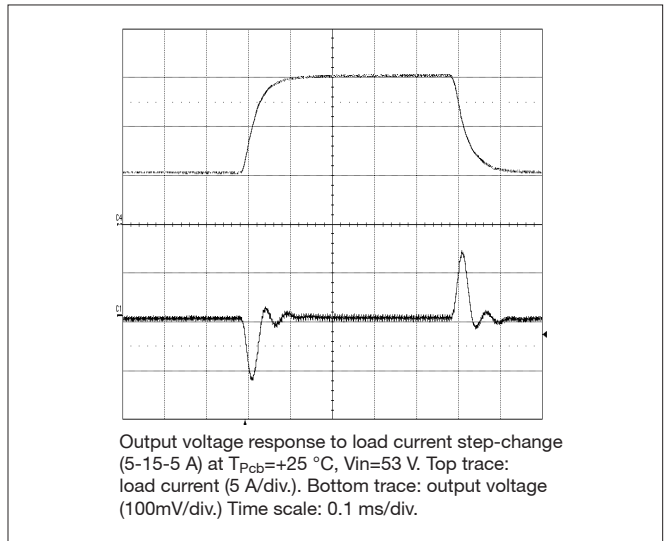

Output Voltage Adjust (see operating information)

The resistor value for an adjusted output voltage is calculated by using the following equations:

Output Voltage Adjust Upwards, Increase:

$$R_{adj} = \frac{8.85 \times (100 + \Delta\%) \times 9.1 \times 1.2}{21.1 \times \Delta\% \times 1.225} - 5.11 \text{ k}\Omega$$

Eg Increase 4% => $V_{out} = 1.248 V_{dc}$

$$R_{adj} = \frac{8.85 \times (100 + 4) \times 9.1 \times 1.2}{21.1 \times 4 \times 1.225} - 5.11 \text{ k}\Omega = 92 \text{ k}\Omega$$

Output Voltage Adjust Downwards, Decrease:

$$R_{adj} = \frac{1}{\left(\frac{1}{12} + \frac{1}{9.1}\right) \left(\frac{100}{100 - \Delta\%} - 1\right)} - 5.11 \text{ k}\Omega$$

Eg Decrease 4% => $V_{out} = 1.152 V_{dc}$

$$R_{adj} = \frac{1}{\left(\frac{1}{12} + \frac{1}{9.1}\right) \left(\frac{100}{100 - 4} - 1\right)} - 5.11 \text{ k}\Omega = 119.1 \text{ k}\Omega$$

PKM 4318HE PI Output

$T_{Pcb} = -40...+90\text{ °C}$ and $V_I = 36...75\text{V}$, sense pins connected to output pins unless otherwise specified.

Characteristics		Conditions	Output			Unit
			min	typ	max	
V_{O1}	Output voltage initial setting and accuracy	$I_{Omax}, V_I = 53\text{ V}, T_{Pcb} = 25\text{ °C}$	1.468	1.5	1.532	V
	Output adjust range	$I_{Omax}, V_I = 53\text{ V}, T_{Pcb} = 25\text{ °C}$	1.35		1.65	V
V_O	Output voltage tolerance band	$I_O = (0.1...1.0) \times I_{Omax}$	1.455		1.545	V
	Idling voltage	$I_O = 0$	1.455		1.545	V
	Line regulation	I_{Omax}			5	mV
	Load regulation	$I_O = (0.01...1.0) \times I_{Omax}, V_I = 53\text{ V}$			5	mV
V_{tr}	Load transient voltage deviation	$I_O = (0.1...1.0) \times I_{Omax}, V_I = 53\text{ V},$ load step = $0.5 \times I_{Omax}$		± 100		mV
t_{tr}	Load transient recovery time	$I_O = (0.1...1.0) \times I_{Omax}, V_I = 53\text{ V},$ load step = $0.5 \times I_{Omax}$		100		μs
t_r	Ramp-up time	$I_O = (0.1...1.0) \times I_{Omax}, V_I = 53\text{ V}$ $(0.1...0.9) \times V_{Onom}$		5	10	ms
t_s	Start-up time	$I_O = (0.1...1.0) \times I_{Omax}, V_I = 53\text{ V}$ V_I connection to $0.9 \times V_{Onom}$		7.5	15	ms
I_O	Output current		0		20	A
P_{Omax}	Max output power	At $V_O = V_{Onom}$	30			W
I_{lim}	Current limit threshold	$T_{Pcb} < T_{Pcbmax}$		25		A
I_{sc}	Short circuit current	$T_{Pcb} = 25\text{ °C}, V_O < 0.5\text{V}$		28.5		A
V_{Oac}	Output ripple & noise	See ripple and noise, $I_{Omax}, V_{Onom},$		35	60	mV_{p-p}
SVR	Supply voltage rejection (ac)	$T_{Pcb} = 25\text{ °C}, f = 100\text{ Hz}$ sinewave, $1\text{ V}_{pp},$ $V_I = 53\text{ V}$		67		dB
OVP	Over voltage protection	$V_I = 53\text{ V } I_O = (0.1...1.0) \times I_{Omax}$	1.8		2.5	V

Miscellaneous

Characteristics		Conditions	min	typ	max	Unit
η	Efficiency - 50% load	$T_{Pcb} = +25\text{ °C}, V_I = 48\text{ V}, I_O = 0.5 \times I_{Omax}$		86		%
η	Efficiency - 100% load	$T_{Pcb} = +25\text{ °C}, V_I = 48\text{ V}, I_O = I_{Omax}$		85.5		%
η	Efficiency - 50% load	$T_{Pcb} = +25\text{ °C}, V_I = 53\text{ V}, I_O = 0.5 \times I_{Omax}$		86		%
η	Efficiency - 100% load	$T_{Pcb} = +25\text{ °C}, V_I = 53\text{ V}, I_O = I_{Omax}$	83.5	85.5		%
P_d	Power Dissipation	$I_{Omax}, V_I = 53\text{ V}, T_{Pcb} = 25\text{ °C}$		5.2		W
f_s	Switching frequency			180		kHz

PKM 4318HE PI Typical Characteristics

Efficiency

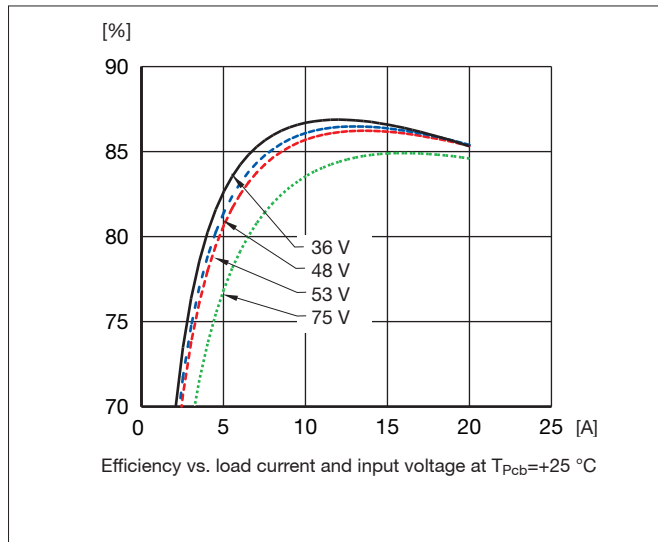

Output Current Derating

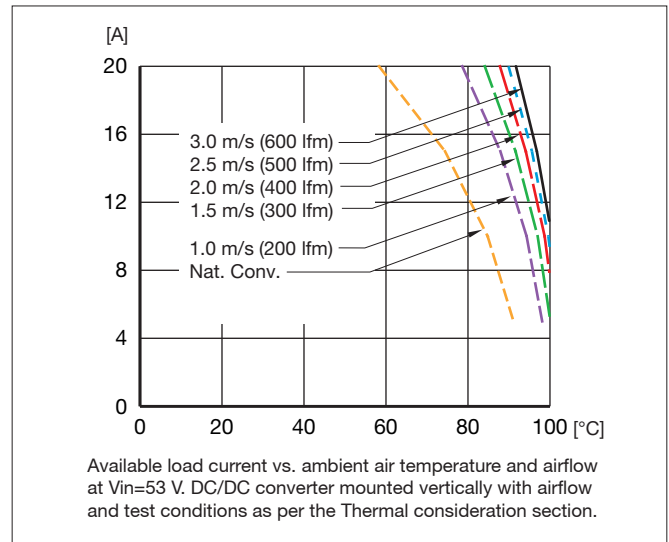

Power Dissipation

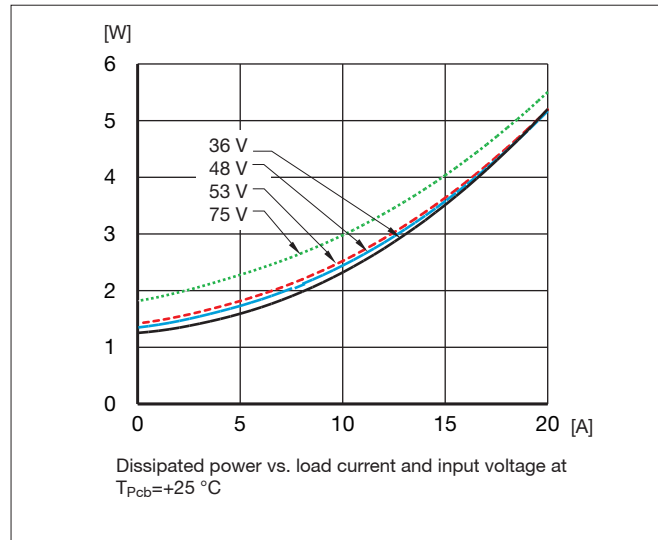

Thermal resistance

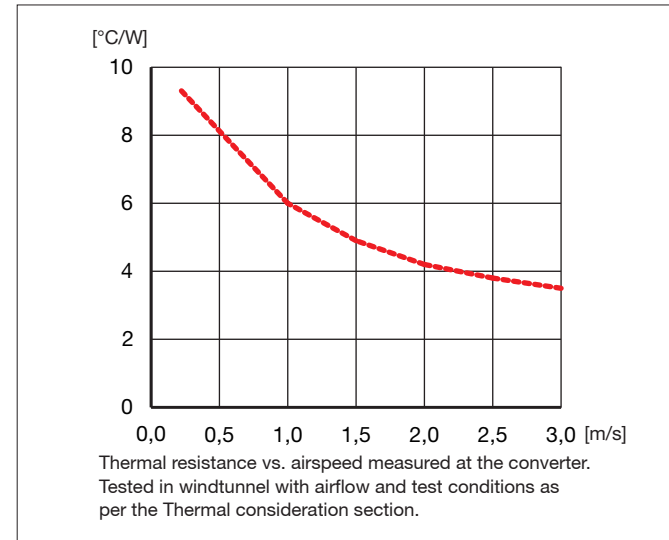

Output Characteristic

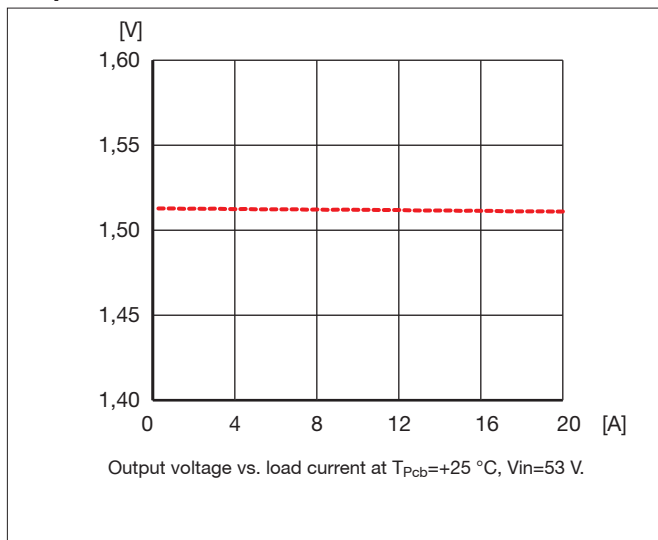

Heatsink (HS) option

The PKM4000E series DC/DC converters can be ordered with a heatsink (HS) option. The heatsink option have approximately 5 °C improved derating compared with the PKM4000E without heatsink. The HS option is intended to be mounted on a cold wall to transfer heat away from the converter.

PKM 4318HE PI Typical Characteristics

Start-Up

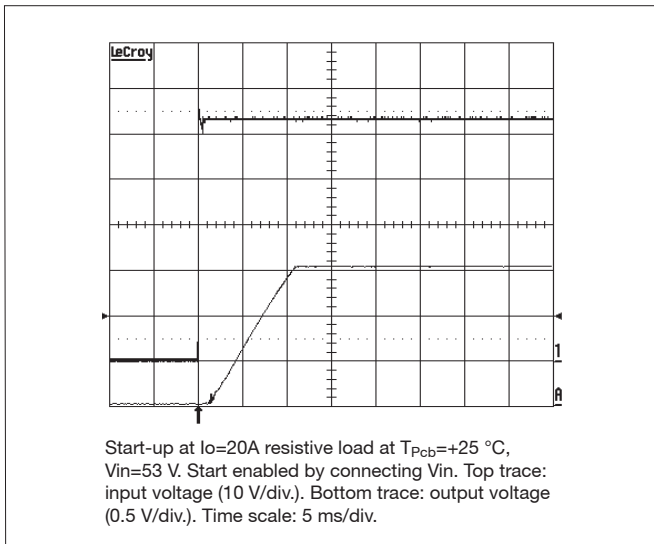

Turn-Off

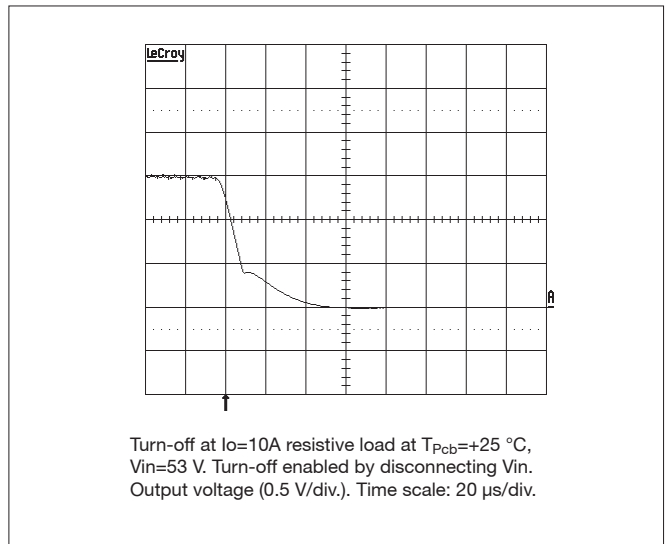

Output Ripple

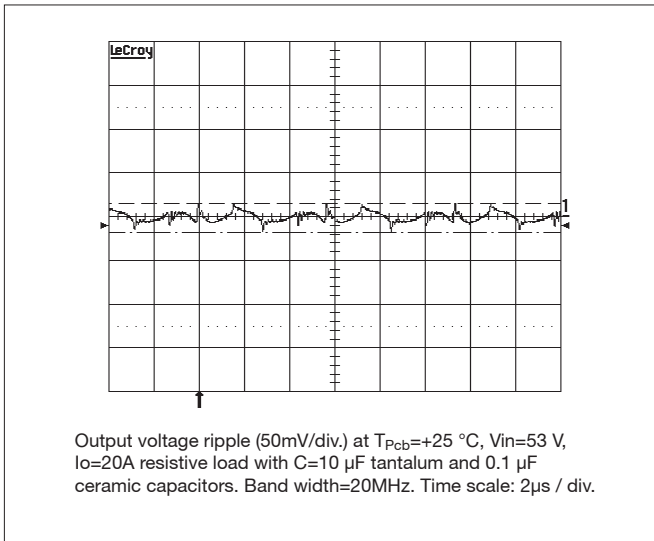

Transient

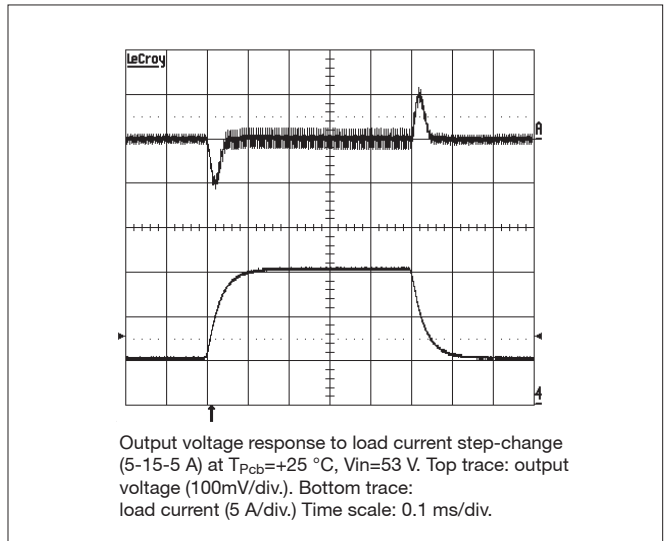

Output Voltage Adjust

The resistor value for an adjusted output voltage is calculated by using the following equations:

Output Voltage Adjust Upwards, Increase:

$$R_{adj} = 5.11 [1.5(100+\Delta\%)/1.225\Delta\% - (100+2\Delta\%)/\Delta\%] \text{ kOhm}$$

Output Voltage Adjust Downwards, Decrease:

$$R_{adj} = 5.11 [(100/\Delta\%-2)] \text{ kOhm}$$

Eg Increase 4% $\Rightarrow V_{out} = 1.56\text{ V}_{dc}$

$$5.11 [1.5(100+4)/(1.225 \times 4) - (100+2 \times 4)/4] = 24.7 \text{ kOhm}$$

Eg Decrease 2% $\Rightarrow V_{out} = 1.47\text{ V}_{dc}$

$$5.11 \times (100/2 - 2) = 245.3 \text{ kOhm}$$

Output Voltage Adjust

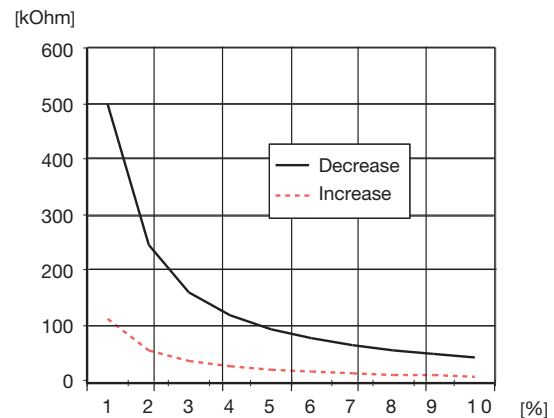

Output voltage adjust resistor value vs. percentage change in output voltage.

PKM 4318GE PI Output

$T_{Pcb} = -40...+90\text{ °C}$ and $V_I = 36...75\text{V}$, sense pins connected to output pins unless otherwise specified.

Characteristics		Conditions	Output			Unit
			min	typ	max	
V_{O1}	Output voltage initial setting and accuracy	$I_{Omax}, V_I = 53\text{ V}, T_{Pcb} = 25\text{ °C}$	1.77	1.80	1.83	V
	Output adjust range	$I_{Omax}, V_I = 53\text{ V}, T_{Pcb} = 25\text{ °C}$	1.62		1.98	V
V_O	Output voltage tolerance band	$I_O = (0.1...1.0) \times I_{Omax}$	1.75		1.85	V
	Idling voltage	$I_O = 0$	1.75		1.85	V
	Line regulation	I_{Omax}			5	mV
	Load regulation	$I_O = (0.01...1.0) \times I_{Omax}, V_I = 53\text{ V}$			5	mV
V_{tr}	Load transient voltage deviation	$I_O = (0.1...1.0) \times I_{Omax}, V_I = 53\text{ V},$ load step = $0.5 \times I_{Omax}$		± 150		mV
t_{tr}	Load transient recovery time	$I_O = (0.1...1.0) \times I_{Omax}, V_I = 53\text{ V},$ load step = $0.5 \times I_{Omax}$		100		μs
t_r	Ramp-up time	$I_O = (0.1...1.0) \times I_{Omax}, V_I = 53\text{ V}$ $(0.1...0.9) \times V_{Onom}$		5	10	ms
t_s	Start-up time	$I_O = (0.1...1.0) \times I_{Omax}, V_I = 53\text{ V}$ V_I connection to $0.9 \times V_{Onom}$		7.5	15	ms
I_O	Output current		0		20	A
P_{Omax}	Max output power	At $V_O = V_{Onom}$	36			W
I_{lim}	Current limit threshold	$T_{Pcb} < T_{Pcbmax}$		25		A
I_{sc}	Short circuit current	$T_{Pcb} = 25\text{ °C}, V_O < 0.5\text{V}$		30		A
V_{Oac}	Output ripple & noise	See ripple and noise, $I_{Omax}, V_{Onom},$		35	50	mV_{p-p}
SVR	Supply voltage rejection (ac)	$T_{Pcb} = 25\text{ °C}, f = 100\text{ Hz}$ sinewave , 1 Vpp, $V_I = 53\text{ V}$		67		dB
OVP	Over voltage protection	$V_I = 53\text{ V } I_O = (0.1...1.0) \times I_{Omax}$	2.1		2.9	V

Miscellaneous

Characteristics		Conditions	min	typ	max	Unit
η	Efficiency - 50% load	$T_{Pcb} = +25\text{ °C}, V_I = 48\text{ V}, I_O = 0.5 \times I_{Omax}$		86.5		%
η	Efficiency - 100% load	$T_{Pcb} = +25\text{ °C}, V_I = 48\text{ V}, I_O = I_{Omax}$		85		%
η	Efficiency - 50% load	$T_{Pcb} = +25\text{ °C}, V_I = 53\text{ V}, I_O = 0.5 \times I_{Omax}$		86.5		%
η	Efficiency - 100% load	$T_{Pcb} = +25\text{ °C}, V_I = 53\text{ V}, I_O = I_{Omax}$	84	85.5		%
P_d	Power Dissipation	$I_{Omax}, V_I = 53\text{ V}, T_{Pcb} = 25\text{ °C}$		6		W
f_s	Switching frequency			180		kHz

PKM 4318GE PI Typical Characteristics

Efficiency

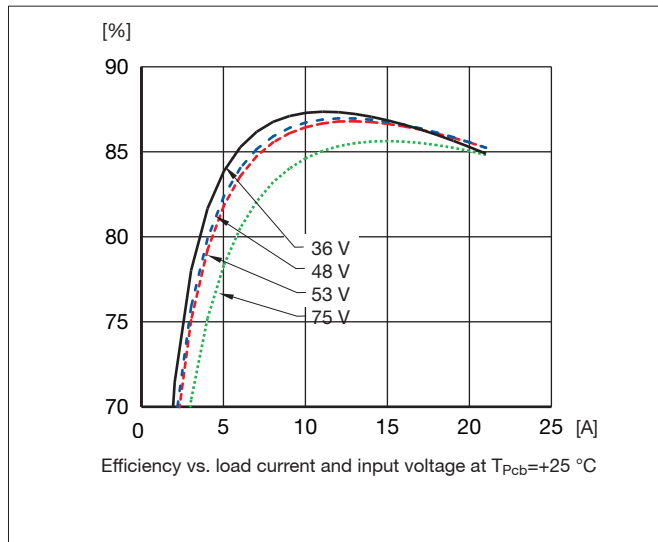

Output Current Derating

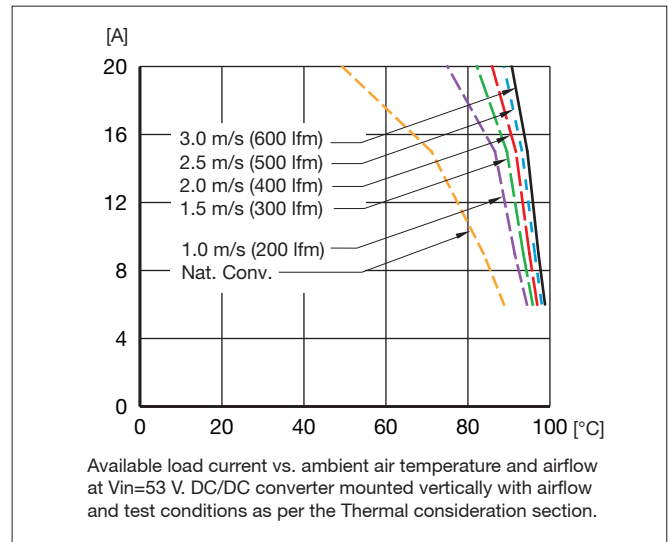

Power Dissipation

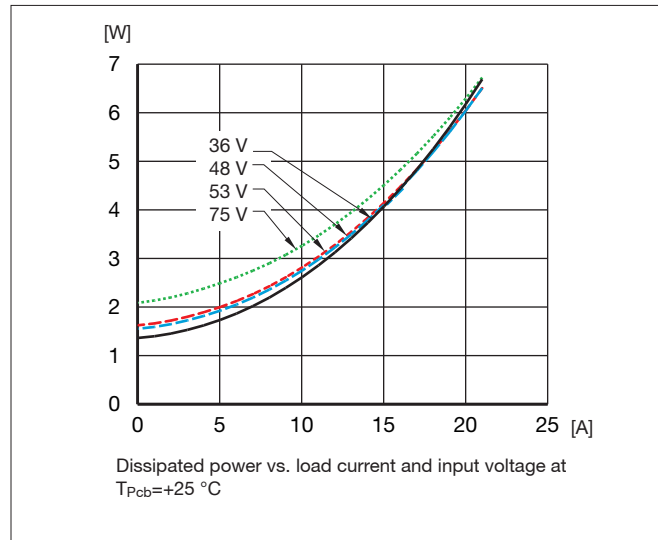

Thermal resistance

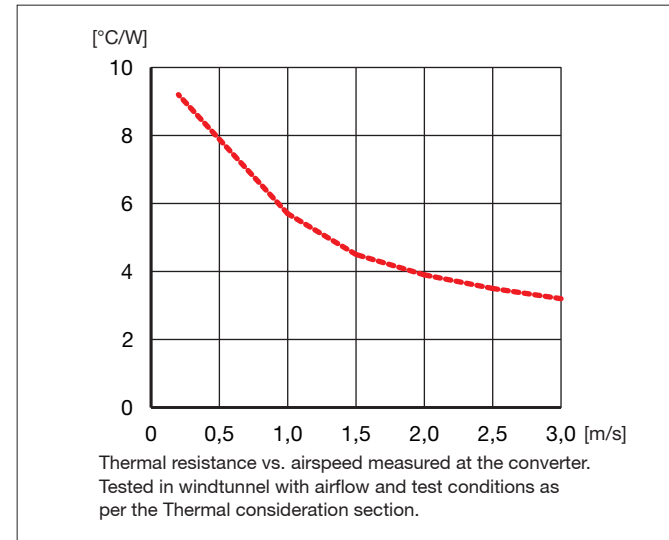

Output Characteristic

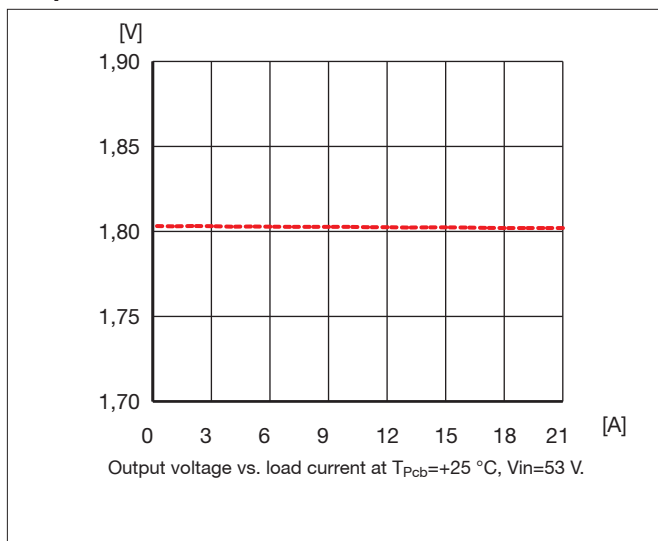

Heatsink (HS) option

The PKM4000E series DC/DC converters can be ordered with a heatsink (HS) option. The heatsink option have approximately 5 °C improved derating compared with the PKM4000E without heatsink. The HS option is intended to be mounted on a cold wall to transfer heat away from the converter.

PKM 4318GE PI Typical Characteristics

Start-Up

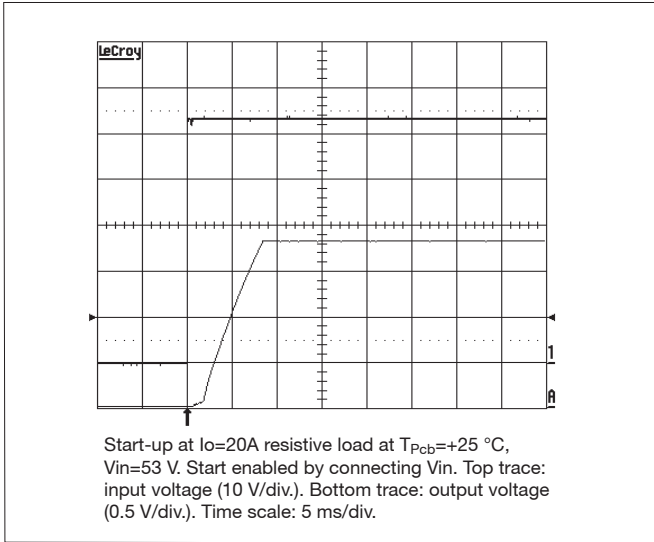

Turn-Off

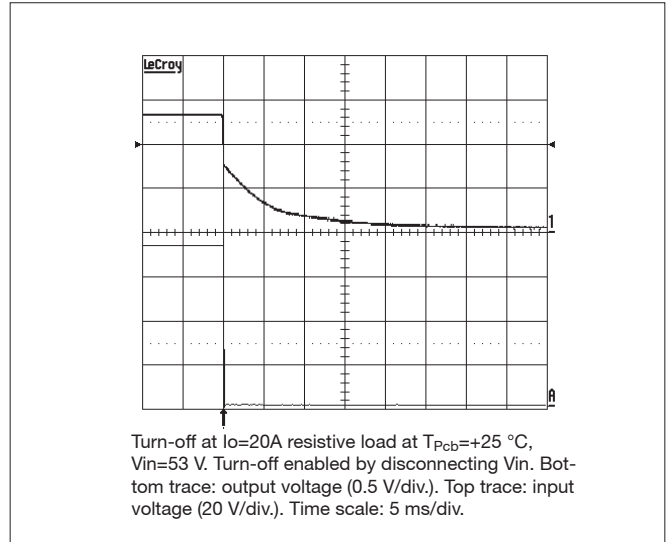

Output Ripple

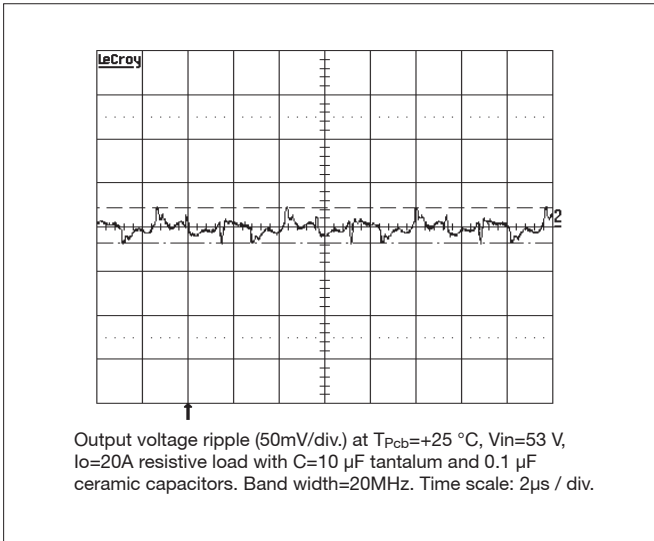

Transient

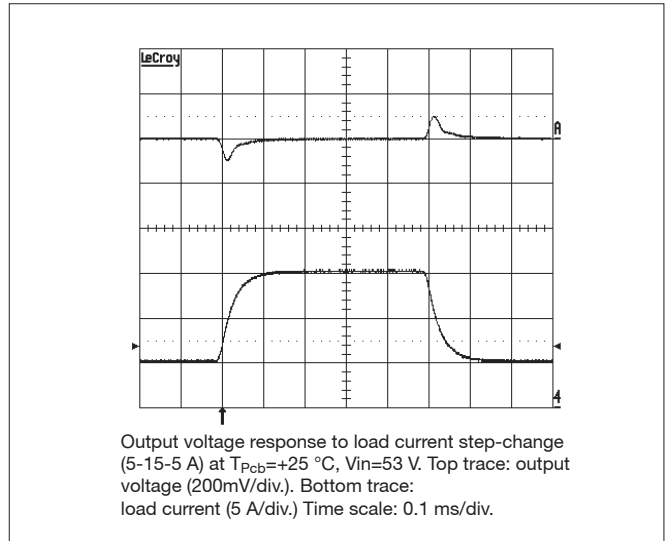

Output Voltage Adjust

The resistor value for an adjusted output voltage is calculated by using the following equations:

Output Voltage Adjust Upwards, Increase:

$$R_{adj} = 5.11 [1.5(100+\Delta\%)/1.225\Delta\% - (100+2\Delta\%)/\Delta\%] \text{ kOhm}$$

Output Voltage Adjust Downwards, Decrease:

$$R_{adj} = 5.11 [(100/\Delta\%-2)] \text{ kOhm}$$

Eg Increase 4% $\Rightarrow V_{out} = 1.56\text{ V}_{dc}$

$$5.11 [1.5(100+4)/(1.225 \times 4) - (100+2 \times 4)/4] = 24.7 \text{ kOhm}$$

Eg Decrease 2% $\Rightarrow V_{out} = 1.47\text{ V}_{dc}$

$$5.11 \times (100/2-2) = 245.3 \text{ kOhm}$$

Output Voltage Adjust

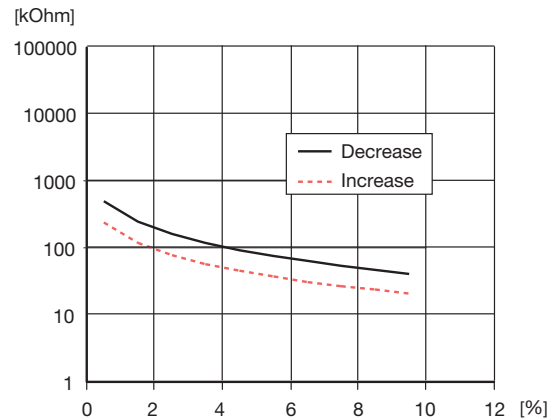

Output voltage adjust resistor value vs. percentage change in output voltage.

PKM 4319E PI Output

$T_{Pcb} = -40...+90\text{ °C}$ and $V_I = 36...75\text{V}$, sense pins connected to output pins unless otherwise specified.

Characteristics		Conditions	Output			Unit
			min	typ	max	
V_{O_i}	Output voltage initial setting and accuracy	I_{Omax} , $V_I = 53\text{ V}$, $T_{Pcb} = 25\text{ °C}$	2.45	2.50	2.55	V
	Output adjust range	I_{Omax} , $V_I = 53\text{ V}$, $T_{Pcb} = 25\text{ °C}$	2.25		2.75	V
V_O	Output voltage tolerance band	$I_O = (0.1...1.0) \times I_{Omax}$	2.42		2.58	V
	Idling voltage	$I_O = 0$	2.42		2.58	V
	Line regulation	I_{Omax}			5	mV
	Load regulation	$I_O = (0.01...1.0) \times I_{Omax}$, $V_I = 53\text{ V}$			5	mV
V_{tr}	Load transient voltage deviation	$I_O = (0.1...1.0) \times I_{Omax}$, $V_I = 53\text{ V}$, load step = $0.5 \times I_{Omax}$		± 100		mV
t_{tr}	Load transient recovery time	$I_O = (0.1...1.0) \times I_{Omax}$, $V_I = 53\text{ V}$, load step = $0.5 \times I_{Omax}$		100		μs
t_r	Ramp-up time	$I_O = (0.1...1.0) \times I_{Omax}$, $V_I = 53\text{ V}$ ($0.1...0.9$) $\times V_{Onom}$		5	10	ms
t_s	Start-up time	$I_O = (0.1...1.0) \times I_{Omax}$, $V_I = 53\text{ V}$ V_I connection to $0.9 \times V_{Onom}$		7.5	15	ms
I_O	Output current		0		15	A
P_{Omax}	Max output power	At $V_O = V_{Onom}$	37.5			W
I_{lim}	Current limit threshold	$T_{Pcb} < T_{Pcbmax}$		18		A
I_{sc}	Short circuit current	$T_{Pcb} = 25\text{ °C}$, $V_O < 0.5\text{V}$		23		A
V_{Oac}	Output ripple & noise	See ripple and noise, I_{Omax} , V_{Onom} ,		60	90	mV_{p-p}
SVR	Supply voltage rejection (ac)	$T_{Pcb} = 25\text{ °C}$, $f = 100\text{ Hz}$ sinewave, 1 V_{pp} , $V_I = 53\text{ V}$		68		dB
OVP	Over voltage protection	$V_I = 53\text{ V}$ $I_O = (0.1...1.0) \times I_{Omax}$	3.5		5	V

Miscellaneous

Characteristics		Conditions	min	typ	max	Unit
η	Efficiency - 50% load	$T_{Pcb} = +25\text{ °C}$, $V_I = 48\text{ V}$, $I_O = 0.5 \times I_{Omax}$		90		%
η	Efficiency - 100% load	$T_{Pcb} = +25\text{ °C}$, $V_I = 48\text{ V}$, $I_O = I_{Omax}$		89		%
η	Efficiency - 50% load	$T_{Pcb} = +25\text{ °C}$, $V_I = 53\text{ V}$, $I_O = 0.5 \times I_{Omax}$		90		%
η	Efficiency - 100% load	$T_{Pcb} = +25\text{ °C}$, $V_I = 53\text{ V}$, $I_O = I_{Omax}$	87	89		%
P_d	Power Dissipation	I_{Omax} , $V_I = 53\text{ V}$, $T_{Pcb} = 25\text{ °C}$		5.5		W
f_s	Switching frequency			180		kHz

PKM 4319E PI Typical Characteristics

Efficiency

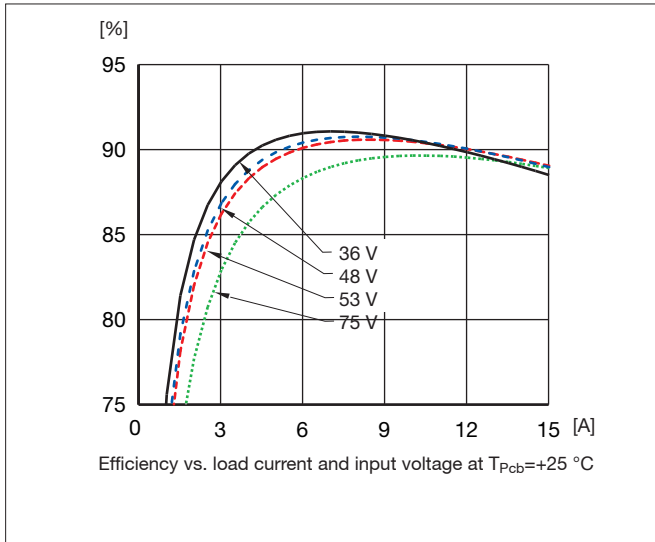

Output Current Derating

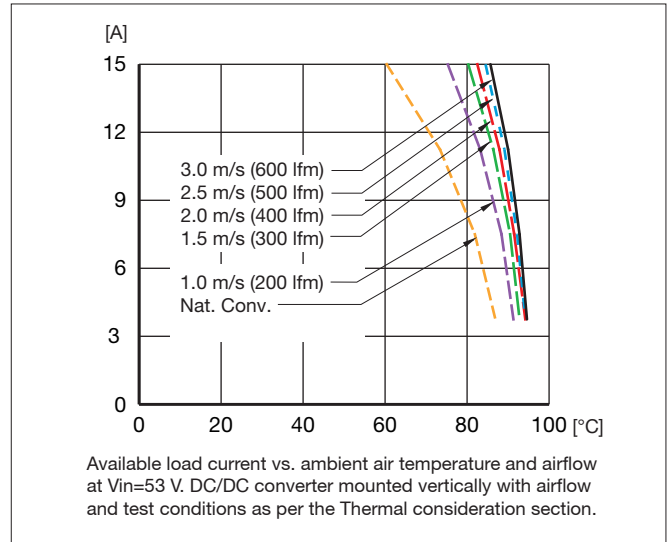

Power Dissipation

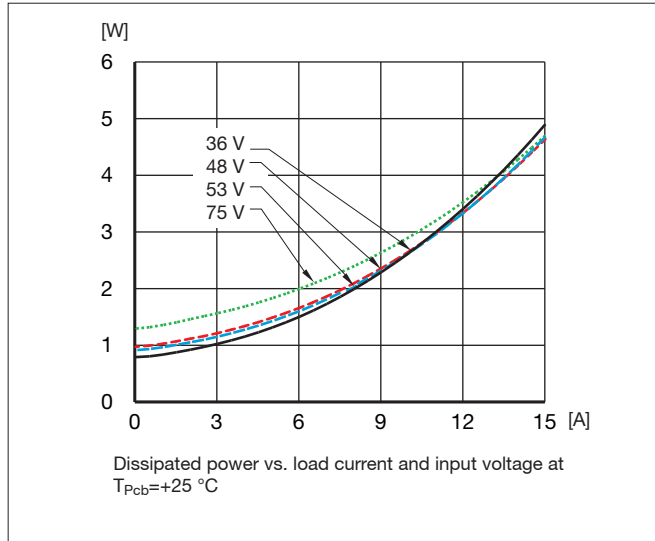

Thermal resistance

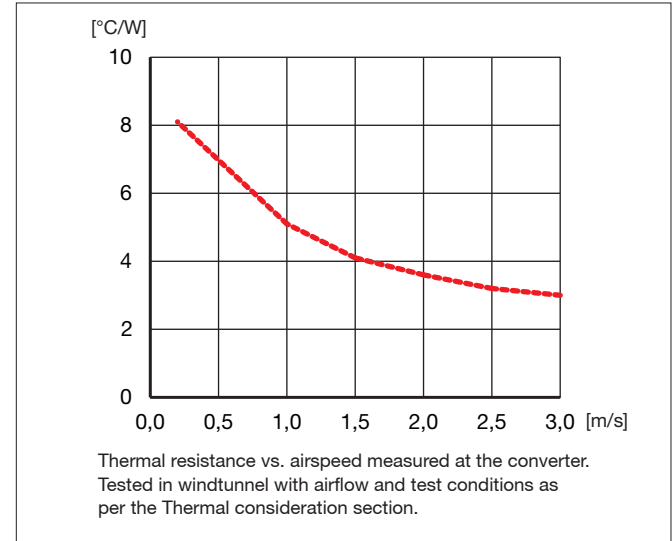

Output Characteristic

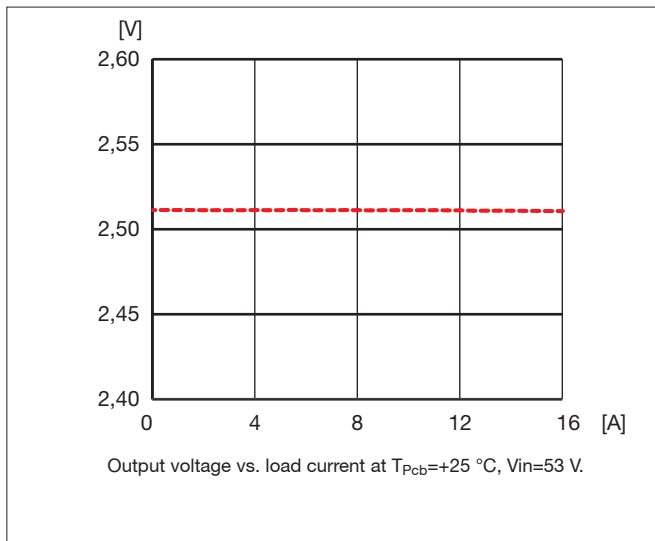

Heatsink (HS) option

The PKM4000E series DC/DC converters can be ordered with a heatsink (HS) option. The heatsink option have approximately 5 °C improved derating compared with the PKM4000E without heatsink. The HS option is intended to be mounted on a cold wall to transfer heat away from the converter.

PKM 4319E PI Typical Characteristics

Start-Up

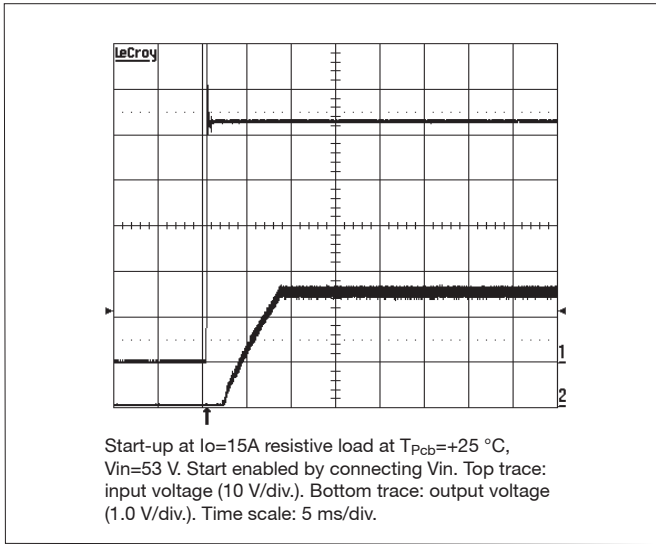

Turn-Off

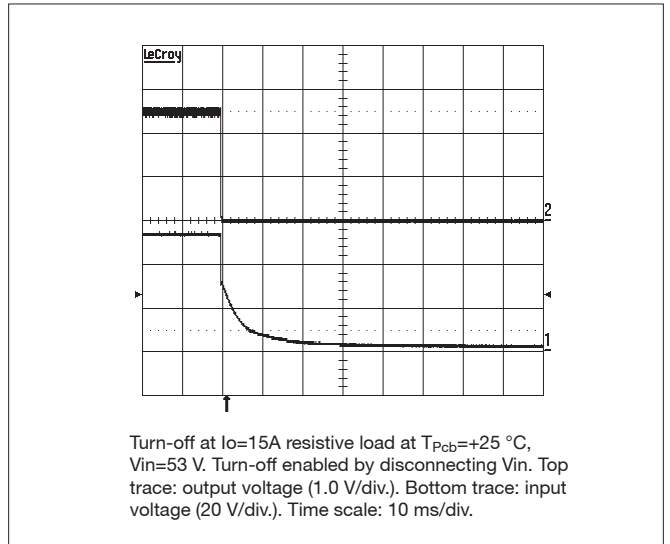

Output Ripple

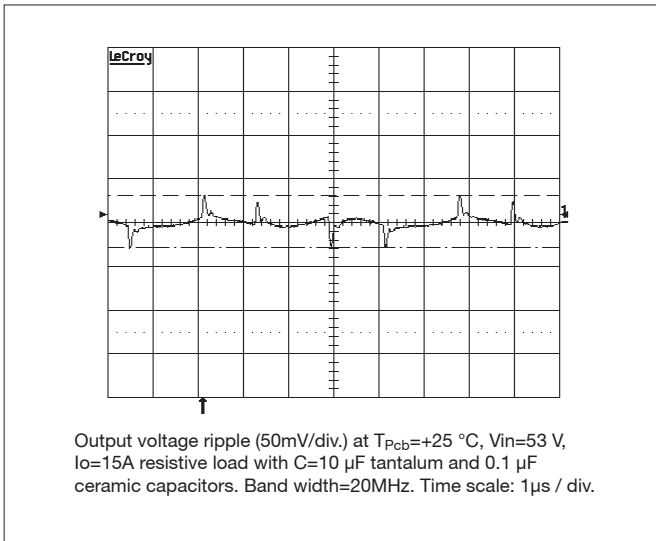

Transient

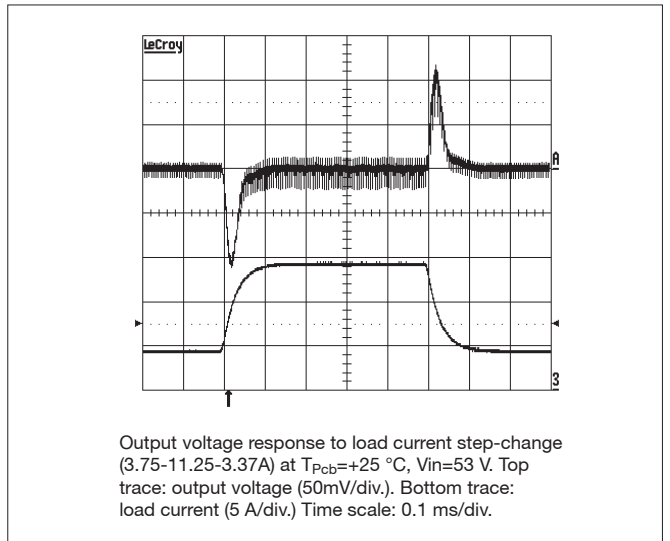

Output Voltage Adjust

The resistor value for an adjusted output voltage is calculated by using the following equations:

Output Voltage Adjust Upwards, Increase:

$$R_{adj} = 5.11 [2.5(100+\Delta\%)/1.225\Delta\% - (100+2\Delta\%)/\Delta\%] \text{ kOhm}$$

Output Voltage Adjust Downwards, Decrease:

$$R_{adj} = 5.11 [(100/\Delta\%)-2] \text{ kOhm}$$

Eg Increase 4% => $V_{out} = 2.6\text{ V}_{dc}$

$$5.11 [2.5(100+4)/(1.225 \times 4) - (100+2 \times 4)/4] = 133 \text{ kOhm}$$

Eg Decrease 2% => $V_{out} = 2.45\text{ V}_{dc}$

$$5.11 \times (100/2 - 2) = 245.3 \text{ kOhm}$$

Output Voltage Adjust

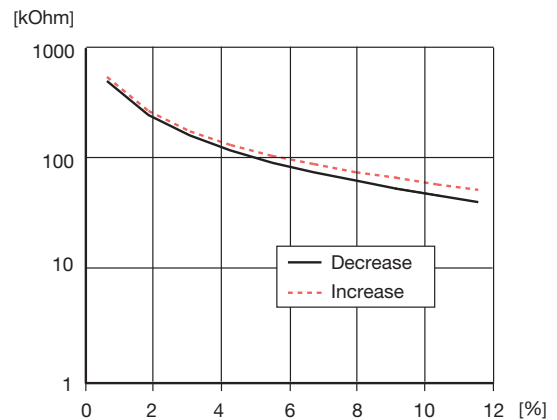

Output voltage adjust resistor value vs. percentage change in output voltage.

PKM 4510E PI Output

$T_{Pcb} = -40...+90\text{ }^{\circ}\text{C}$ and $V_I = 36...75\text{V}$, sense pins connected to output pins unless otherwise specified.

Characteristics		Conditions	Output			Unit
			min	typ	max	
V_{O_i}	Output voltage initial setting and accuracy	$I_{Omax}, V_I = 53\text{ V}, T_{Pcb} = 25\text{ }^{\circ}\text{C}$	3.23	3.3	3.37	V
	Output adjust range	$I_{Omax}, V_I = 53\text{ V}, T_{Pcb} = 25\text{ }^{\circ}\text{C}$	2.97		3.63	V
V_O	Output voltage tolerance band	$I_O = (0.1...1.0) \times I_{Omax}$	3.2		3.4	V
	Idling voltage	$I_O = 0$	3.2		3.4	V
	Line regulation	I_{Omax}			5	mV
	Load regulation	$I_O = (0.01...1.0) \times I_{Omax}, V_I = 53\text{ V}$			5	mV
V_{tr}	Load transient voltage deviation	$I_O = (0.1...1.0) \times I_{Omax}, V_I = 53\text{ V},$ load step = $0.5 \times I_{Omax}$		± 250		mV
t_{tr}	Load transient recovery time	$I_O = (0.1...1.0) \times I_{Omax}, V_I = 53\text{ V},$ load step = $0.5 \times I_{Omax}$		100		μs
t_r	Ramp-up time	$I_O = (0.1...1.0) \times I_{Omax}, V_I = 53\text{ V}$ $(0.1...0.9) \times V_{Onom}$		5	10	ms
t_s	Start-up time	$I_O = (0.1...1.0) \times I_{Omax}, V_I = 53\text{ V}$ V_I connection to $0.9 \times V_{Onom}$		7.5	15	ms
I_O	Output current		0		15	A
P_{Omax}	Max output power	At $V_O = V_{Onom}$	50			W
I_{lim}	Current limit threshold	$T_{Pcb} < T_{Pcbmax}$		20		A
I_{sc}	Short circuit current	$T_{Pcb} = 25\text{ }^{\circ}\text{C}, V_O < 0.5\text{ V}$		25		A
V_{Oac}	Output ripple & noise	See ripple and noise, $I_{Omax}, V_{Onom},$		25	50	mV _{p-p}
SVR	Supply voltage rejection (ac)	$T_{Pcb} = 25\text{ }^{\circ}\text{C}, f = 100\text{ Hz}$ sinewave, 1 Vpp, $V_I = 53\text{ V}$		70		dB
OVP	Over voltage protection	$V_I = 53\text{ V } I_O = (0.1...1.0) \times I_{Omax}$	3.9		5.0	V

Miscellaneous

Characteristics		Conditions	min	typ	max	Unit
η	Efficiency - 50% load	$T_{Pcb} = +25\text{ }^{\circ}\text{C}, V_I = 48\text{ V}, I_O = 0.5 \times I_{Omax}$		90.5		%
η	Efficiency - 100% load	$T_{Pcb} = +25\text{ }^{\circ}\text{C}, V_I = 48\text{ V}, I_O = I_{Omax}$		89		%
η	Efficiency - 50% load	$T_{Pcb} = +25\text{ }^{\circ}\text{C}, V_I = 53\text{ V}, I_O = 0.5 \times I_{Omax}$		90		%
η	Efficiency - 100% load	$T_{Pcb} = +25\text{ }^{\circ}\text{C}, V_I = 53\text{ V}, I_O = I_{Omax}$	87	89		%
P_d	Power Dissipation	$I_{Omax}, V_I = 53\text{ V}, T_{Pcb} = 25\text{ }^{\circ}\text{C}$		6		W
f_s	Switching frequency			180		kHz

PKM 4510E PI Typical Characteristics

Efficiency

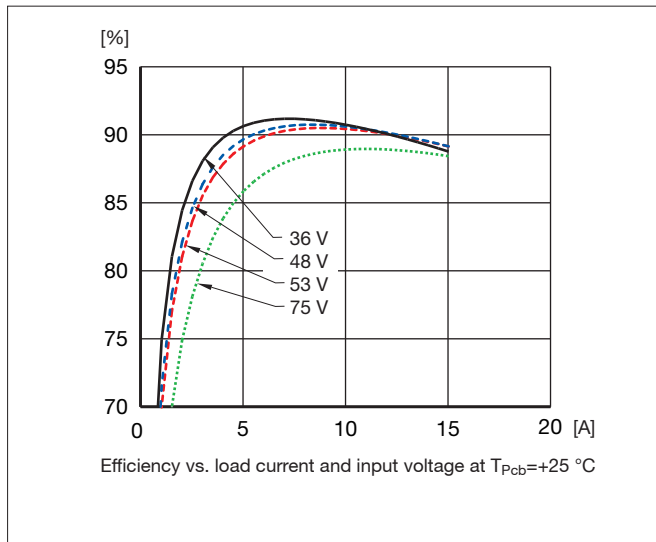

Output Current Derating

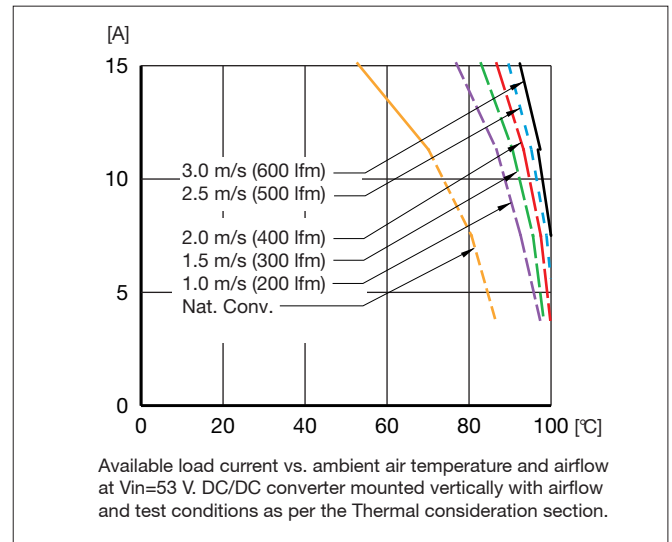

Power Dissipation

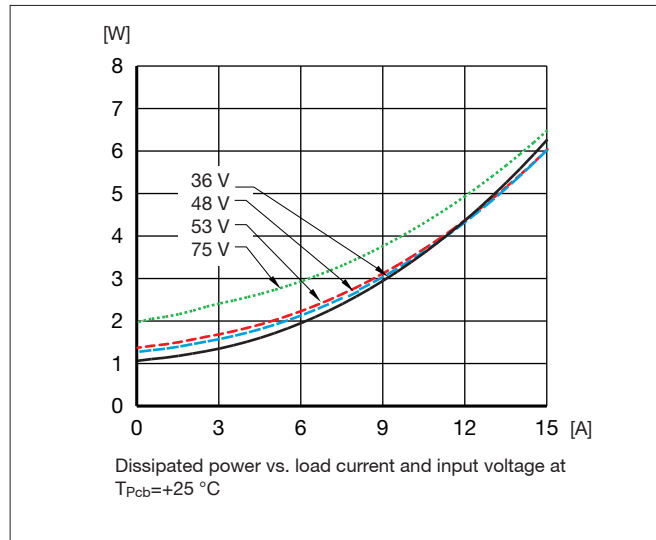

Thermal resistance

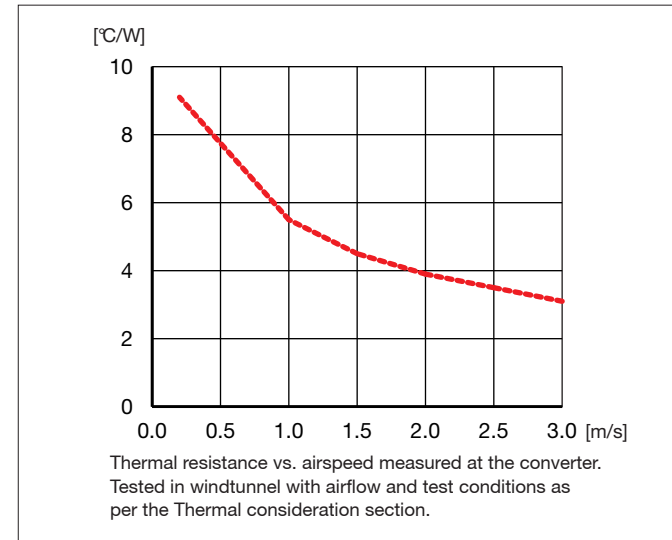

Output Characteristic

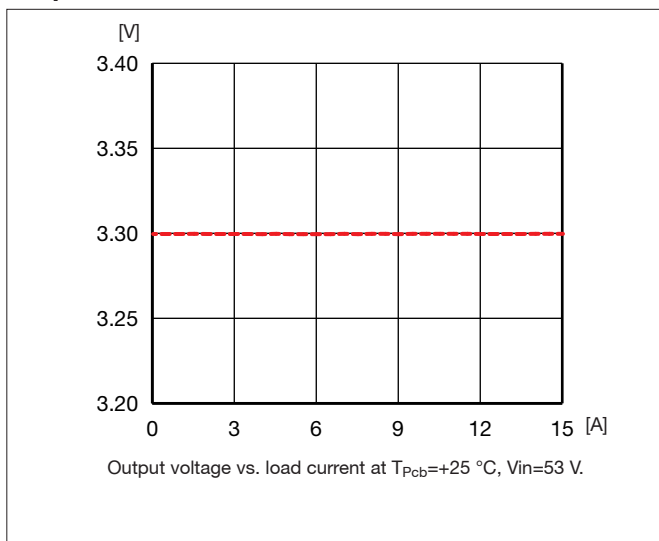

Heatsink (HS) option

The PKM4000E series DC/DC converters can be ordered with a heatsink (HS) option. The heatsink option have approximately 5 °C improved derating compared with the PKM4000E without heatsink. The HS option is intended to be mounted on a cold wall to transfer heat away from the converter.

PKM 4510E PI Typical Characteristics

Start-Up

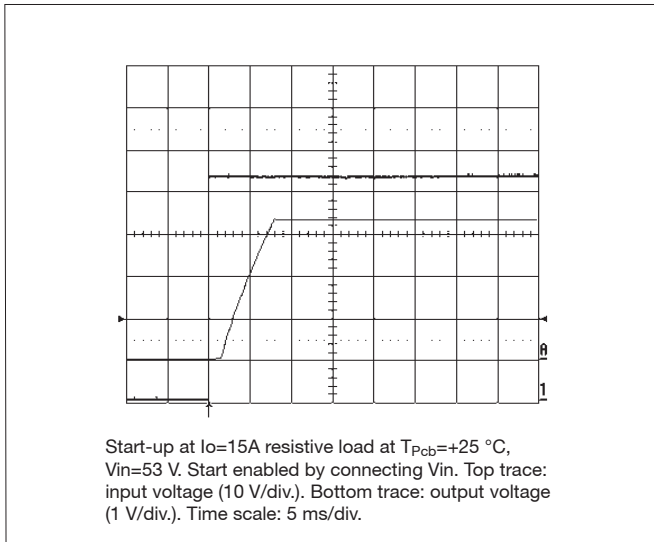

Turn-Off

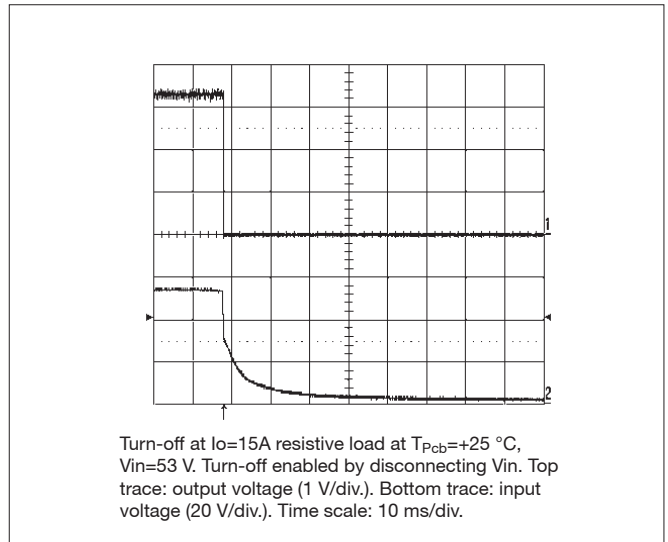

Output Ripple

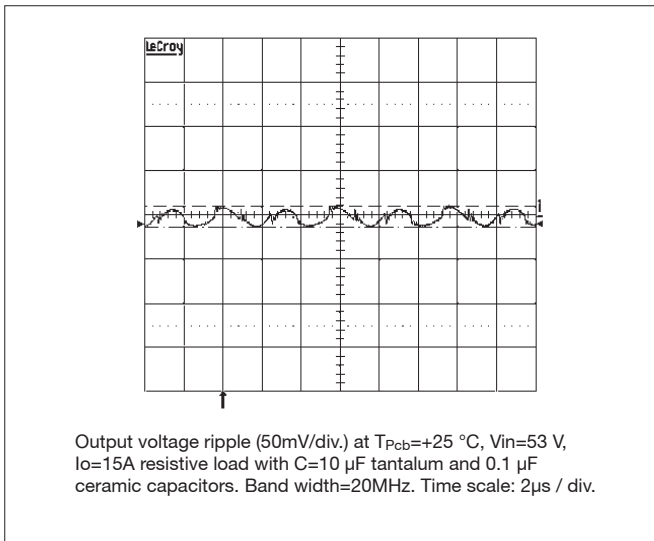

Transient

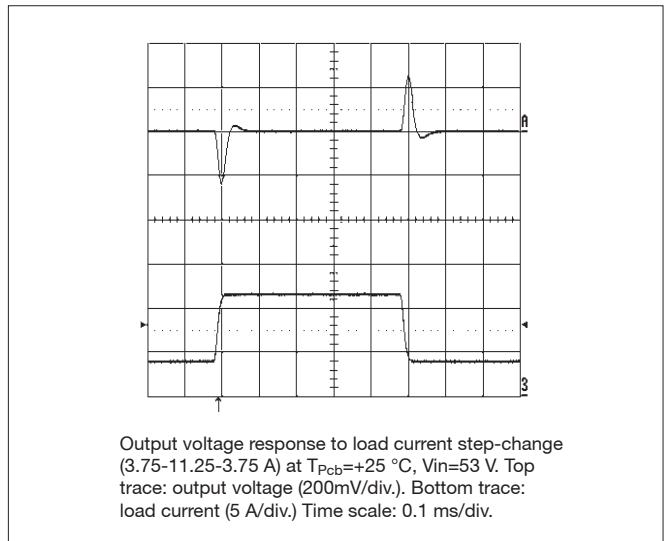

Output Voltage Adjust

The resistor value for an adjusted output voltage is calculated by using the following equations:

Output Voltage Adjust Upwards, Increase:

$$R_{adj} = 5.11 \left[\frac{3.3(100+\Delta\%)}{1.225\Delta\%} - \frac{100+2\Delta\%}{\Delta\%} \right] \text{ kOhm}$$

Output Voltage Adjust Downwards, Decrease:

$$R_{adj} = 5.11 \left[\frac{100}{\Delta\%} - 2 \right] \text{ kOhm}$$

Eg Increase 4% $\Rightarrow V_{out} = 3.43\text{ V}_{dc}$

$$5.11 \left[\frac{3.3(100+4)}{1.225 \times 4} - \frac{100+2 \times 4}{4} \right] = 219.9\text{ kOhm}$$

Eg Decrease 2% $\Rightarrow V_{out} = 3.23\text{ V}_{dc}$

$$5.11 \times \left(\frac{100}{2} - 2 \right) = 245.3\text{ kOhm}$$

Output Voltage Adjust

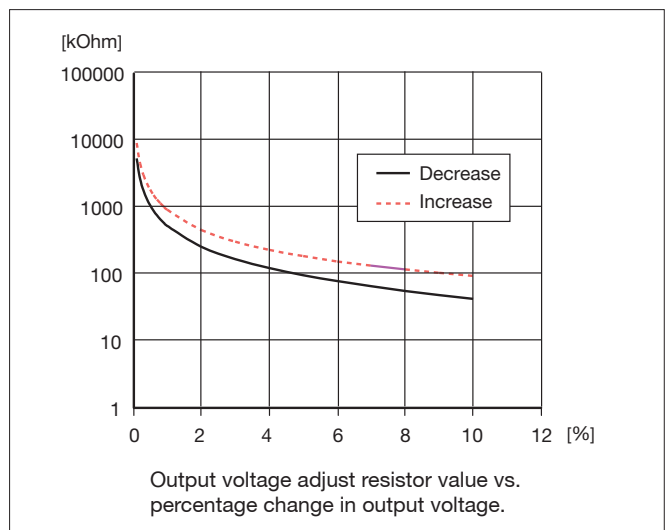

PKM 4511E PI Output

$T_{Pcb} = -40...+90\text{ °C}$ and $V_I = 36...75\text{V}$, sense pins connected to output pins unless otherwise specified.

Characteristics		Conditions	Output			Unit
			min	typ	max	
V_{O_i}	Output voltage initial setting and accuracy	$I_{Omax}, V_I = 53\text{ V}, T_{Pcb} = 25\text{ °C}$	4.89	5.0	5.11	V
	Output adjust range	$I_{Omax}, V_I = 53\text{ V}, T_{Pcb} = 25\text{ °C}$	4.5		5.5	V
V_O	Output voltage tolerance band	$I_O = (0.1...1.0) \times I_{Omax}$	4.85		5.15	V
	Idling voltage	$I_O = 0$	4.85		5.15	V
	Line regulation	I_{Omax}			5	mV
	Load regulation	$I_O = (0.01...1.0) \times I_{Omax}, V_I = 53\text{ V}$			5	mV
V_{tr}	Load transient voltage deviation	$I_O = (0.1...1.0) \times I_{Omax}, V_I = 53\text{ V},$ load step = $0.5 \times I_{Omax}$		± 250		mV
t_{tr}	Load transient recovery time	$I_O = (0.1...1.0) \times I_{Omax}, V_I = 53\text{ V},$ load step = $0.5 \times I_{Omax}$		100		μs
t_r	Ramp-up time	$I_O = (0.1...1.0) \times I_{Omax}, V_I = 53\text{ V}$ $(0.1...0.9) \times V_{Onom}$		5	10	ms
t_s	Start-up time	$I_O = (0.1...1.0) \times I_{Omax}, V_I = 53\text{ V}$ V_I connection to $0.9 \times V_{Onom}$		7.5	15	ms
I_O	Output current		0		10	A
P_{Omax}	Max output power	At $V_O = V_{Onom}$	50			W
I_{lim}	Current limit threshold	$T_{Pcb} < T_{Pcbmax}$		15		A
I_{sc}	Short circuit current	$T_{Pcb} = 25\text{ °C}, V_O < 0.5\text{V}$		25		A
V_{Oac}	Output ripple & noise	See ripple and noise, $I_{Omax}, V_{Onom},$		30	50	mV_{p-p}
SVR	Supply voltage rejection (ac)	$T_{Pcb} = 25\text{ °C}, f = 100\text{ Hz}$ sinewave , $1\text{ V}_{pp},$ $V_I = 53\text{ V}$		75		dB
OVP	Over voltage protection	$V_I = 53\text{ V } I_O = (0.1...1.0) \times I_{Omax}$	5.6		7.6	V

Miscellaneous

Characteristics		Conditions	min	typ	max	Unit
η	Efficiency - 50% load	$T_{Pcb} = +25\text{ °C}, V_I = 48\text{ V}, I_O = 0.5 \times I_{Omax}$		90.5		%
η	Efficiency - 100% load	$T_{Pcb} = +25\text{ °C}, V_I = 48\text{ V}, I_O = I_{Omax}$		90		%
η	Efficiency - 50% load	$T_{Pcb} = +25\text{ °C}, V_I = 53\text{ V}, I_O = 0.5 \times I_{Omax}$		90		%
η	Efficiency - 100% load	$T_{Pcb} = +25\text{ °C}, V_I = 53\text{ V}, I_O = I_{Omax}$	88	90		%
P_d	Power Dissipation	$I_{Omax}, V_I = 53\text{ V}, T_{Pcb} = 25\text{ °C}$		5.5		W
f_s	Switching frequency			180		kHz

PKM 4511E PI Typical Characteristics

Efficiency

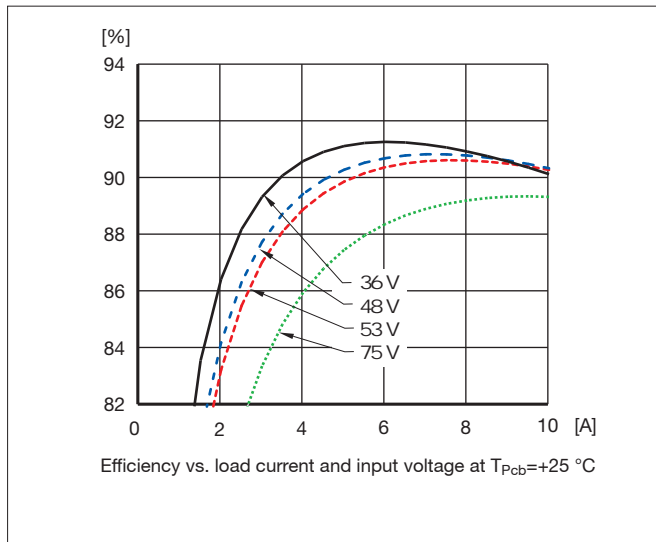

Output Current Derating

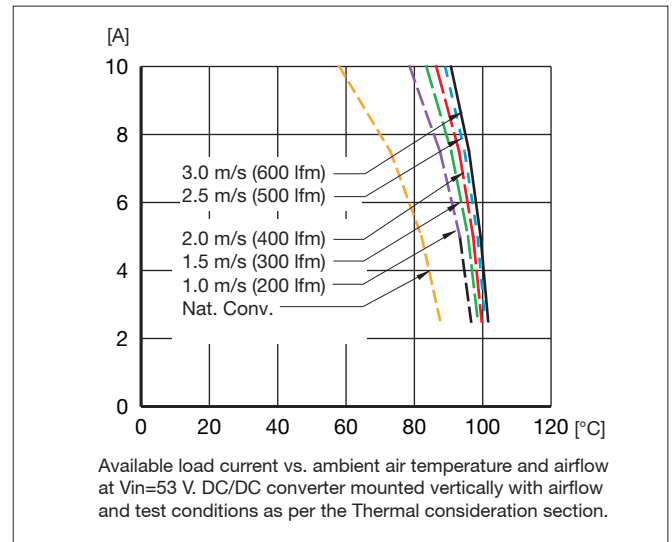

Power Dissipation

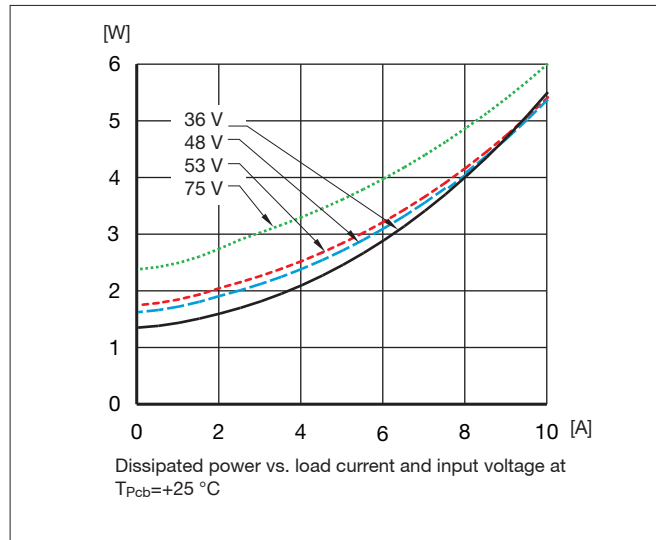

Thermal resistance

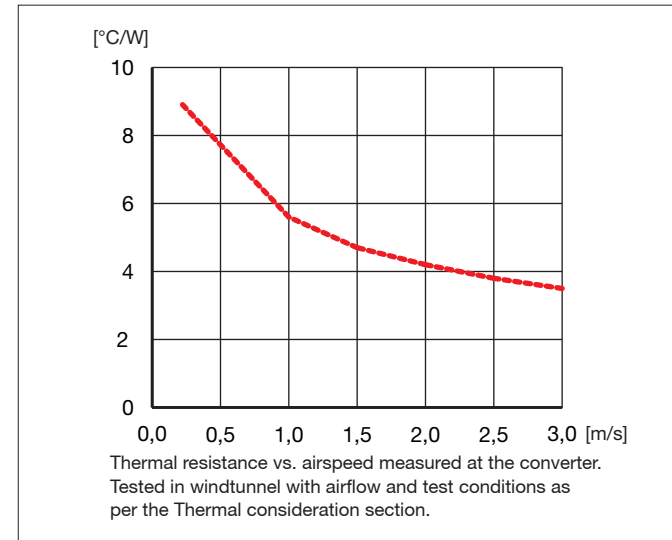

Output Characteristic

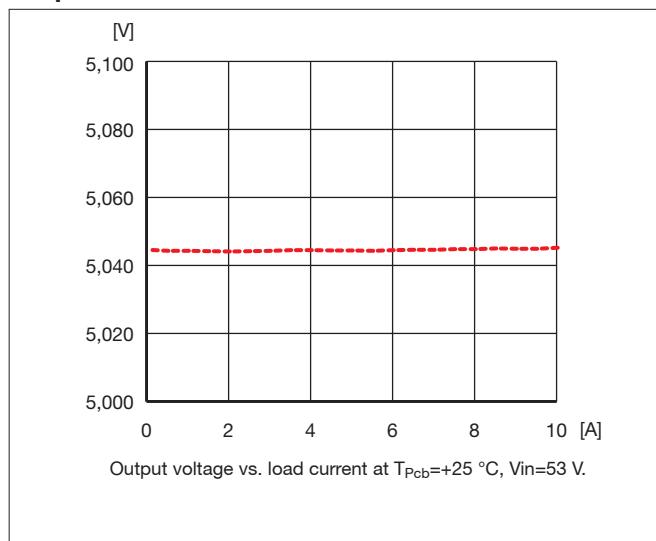

Heatsink (HS) option

The PKM4000E series DC/DC converters can be ordered with a heatsink (HS) option. The heatsink option have approximately 5 °C improved derating compared with the PKM4000E without heatsink. The HS option is intended to be mounted on a cold wall to transfer heat away from the converter.

PKM 4511E PI Typical Characteristics

Start-Up

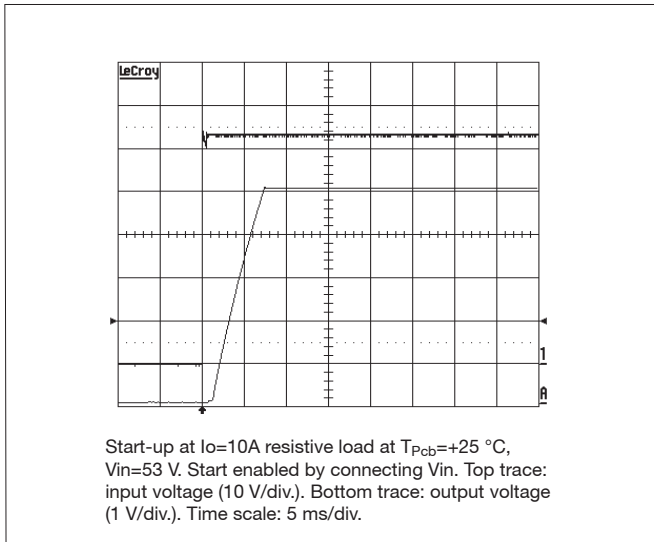

Turn-Off

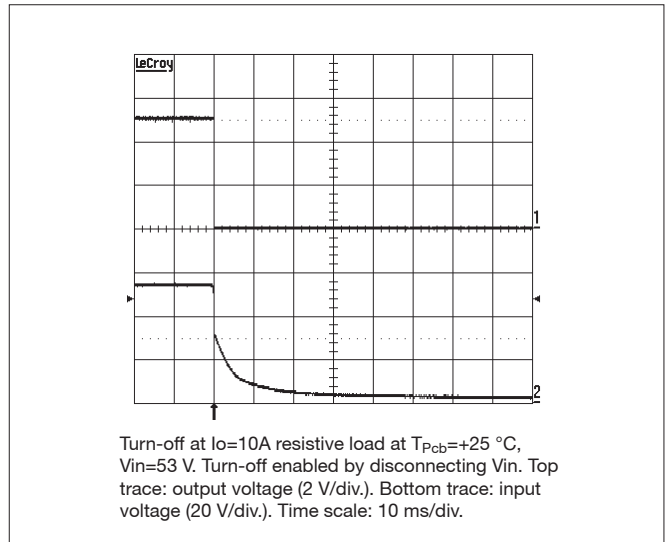

Output Ripple

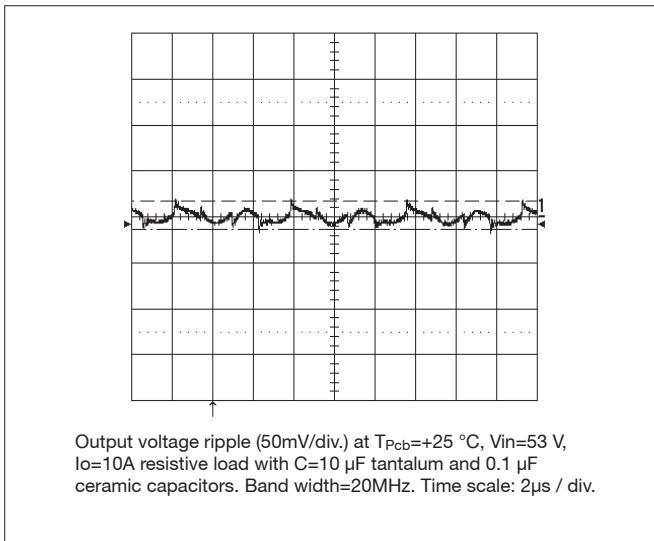

Transient

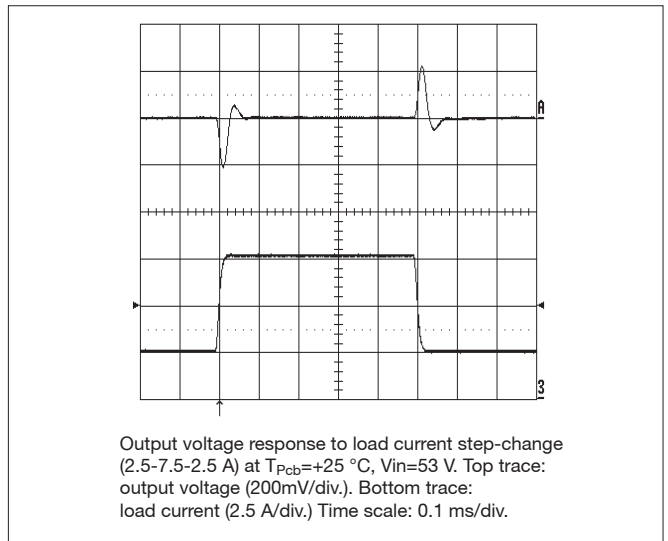

Output Voltage Adjust

The resistor value for an adjusted output voltage is calculated by using the following equations:

Output Voltage Adjust Upwards, Increase:

$$R_{adj} = 5.11 \left[\frac{5(100+\Delta\%)}{1.225\Delta\%} - (100+2\Delta\%)/\Delta\% \right] \text{ k}\Omega$$

Output Voltage Adjust Downwards, Decrease:

$$R_{adj} = 5.11 \left[\frac{100}{\Delta\%} - 2 \right] \text{ k}\Omega$$

Eg Increase 4% $\Rightarrow V_{out} = 5.2\text{ V}_{dc}$

$$5.11 \left[\frac{5(100+4)}{1.225 \times 4} - (100+2 \times 4)/4 \right] = 404.3 \text{ k}\Omega$$

Eg Decrease 2% $\Rightarrow V_{out} = 4.9\text{ V}_{dc}$

$$5.11 \times (100/2 - 2) = 245.3 \text{ k}\Omega$$

Output Voltage Adjust

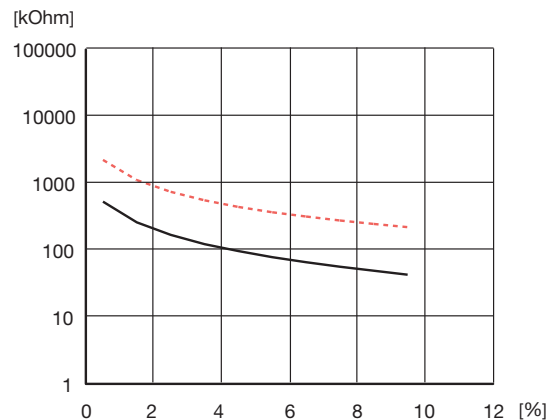

Output voltage adjust resistor value vs. percentage change in output voltage.

PKM 4513E PI Output

$T_{Pcb} = -40...+90\text{ °C}$ and $V_I = 36...75\text{V}$, sense pins connected to output pins unless otherwise specified.

Characteristics		Conditions	Output			Unit
			min	typ	max	
V_{O_i}	Output voltage initial setting and accuracy	$I_{Omax}, V_I = 53\text{ V}, T_{Pcb} = 25\text{ °C}$	11.8	12.0	12.2	V
	Output adjust range	$I_{Omax}, V_I = 53\text{ V}, T_{Pcb} = 25\text{ °C}$	10.8		13.2	V
V_O	Output voltage tolerance band	$I_O = (0.1...1.0) \times I_{Omax}$	11.74		12.26	V
	Idling voltage	$I_O = 0$	11.74		12.26	V
	Line regulation	I_{Omax}			10	mV
	Load regulation	$I_O = (0.01...1.0) \times I_{Omax}, V_I = 53\text{ V}$			10	mV
V_{tr}	Load transient voltage deviation	$I_O = (0.1...1.0) \times I_{Omax}, V_I = 53\text{ V},$ load step = $0.5 \times I_{Omax}$		± 300		mV
t_{tr}	Load transient recovery time	$I_O = (0.1...1.0) \times I_{Omax}, V_I = 53\text{ V},$ load step = $0.5 \times I_{Omax}$		100		μs
t_r	Ramp-up time	$I_O = (0.1...1.0) \times I_{Omax}, V_I = 53\text{ V}$ $(0.1...0.9) \times V_{Onom}$		5	10	ms
t_s	Start-up time	$I_O = (0.1...1.0) \times I_{Omax}, V_I = 53\text{ V}$ V_I connection to $0.9 \times V_{Onom}$		7.5	15	ms
I_O	Output current		0		4.2	A
P_{Omax}	Max output power	At $V_O = V_{Onom}$	50			W
I_{lim}	Current limit threshold	$T_{Pcb} < T_{Pcbmax}$		6.0		A
I_{sc}	Short circuit current	$T_{Pcb} = 25\text{ °C}, V_O < 0.5\text{V}$		9		A
V_{Oac}	Output ripple & noise	See ripple and noise, $I_{Omax}, V_{Onom},$		100	150	mV_{p-p}
SVR	Supply voltage rejection (ac)	$T_{Pcb} = 25\text{ °C}, f = 100\text{ Hz}$ sinewave , $1\text{ V}_{pp},$ $V_I = 53\text{ V}$		75		dB
OVP	Over voltage protection	$V_I = 53\text{ V } I_O = (0.1...1.0) \times I_{Omax}$	14		16	V

Miscellaneous

Characteristics		Conditions	min	typ	max	Unit
η	Efficiency - 50% load	$T_{Pcb} = +25\text{ °C}, V_I = 48\text{ V}, I_O = 0.5 \times I_{Omax}$		87.5		%
η	Efficiency - 100% load	$T_{Pcb} = +25\text{ °C}, V_I = 48\text{ V}, I_O = I_{Omax}$		89		%
η	Efficiency - 50% load	$T_{Pcb} = +25\text{ °C}, V_I = 53\text{ V}, I_O = 0.5 \times I_{Omax}$		87		%
η	Efficiency - 100% load	$T_{Pcb} = +25\text{ °C}, V_I = 53\text{ V}, I_O = I_{Omax}$	87	89		%
P_d	Power Dissipation	$I_{Omax}, V_I = 53\text{ V}, T_{Pcb} = 25\text{ °C}$		6.5		W
f_s	Switching frequency			200		kHz

PKM 4513E PI Typical Characteristics

Efficiency

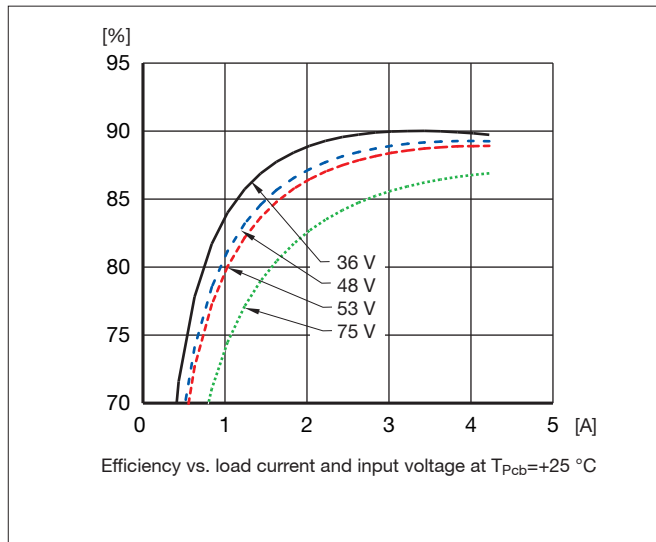

Output Current Derating

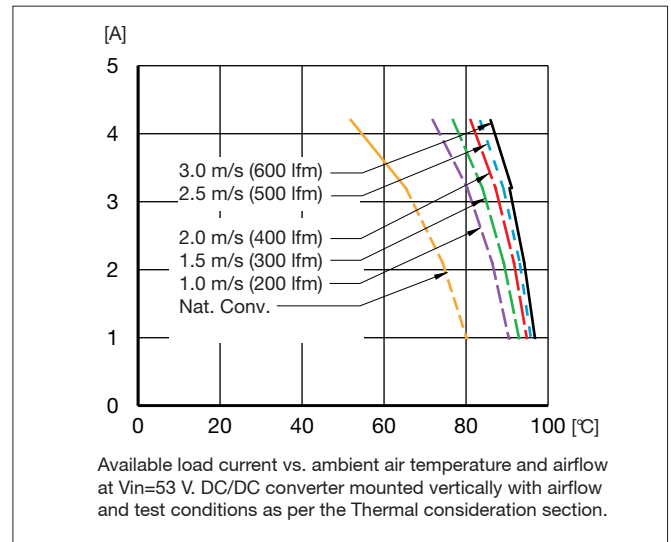

Power Dissipation

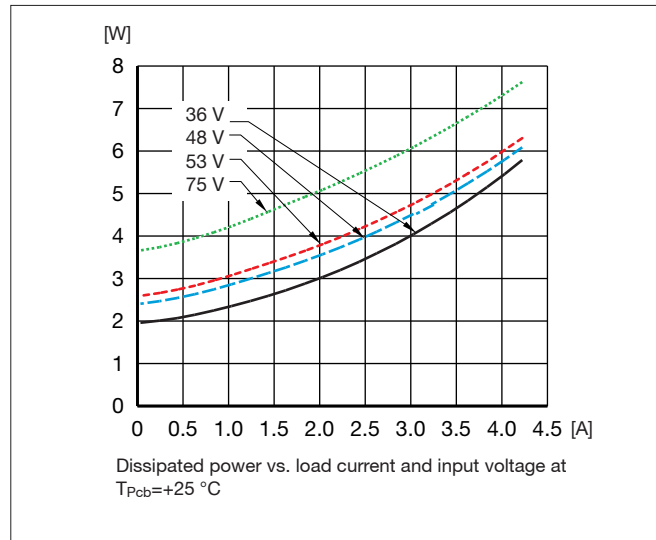

Thermal resistance

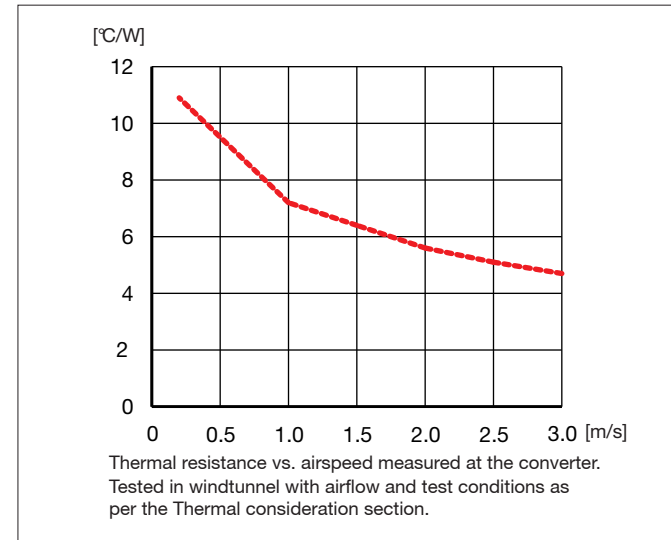

Output Characteristic

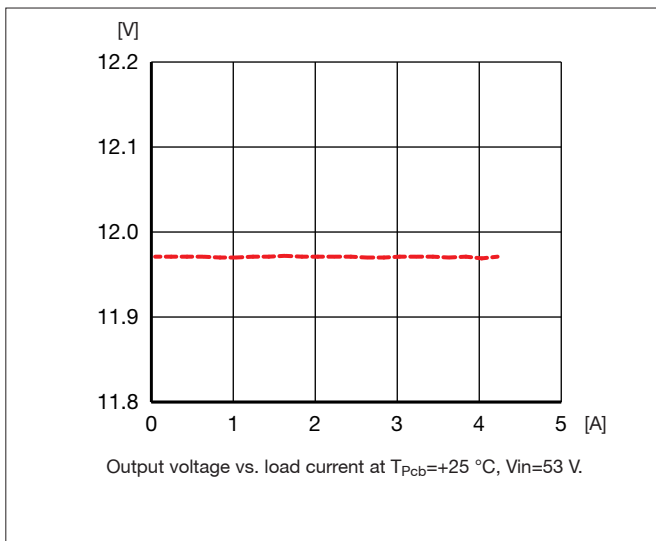

Heatsink (HS) option

The PKM4000E series DC/DC converters can be ordered with a heatsink (HS) option. The heatsink option have approximately 5 $^{\circ}\text{C}$ improved derating compared with the PKM4000E without heatsink. The HS option is intended to be mounted on a cold wall to transfer heat away from the converter.

PKM 4513E PI Typical Characteristics

Start-Up

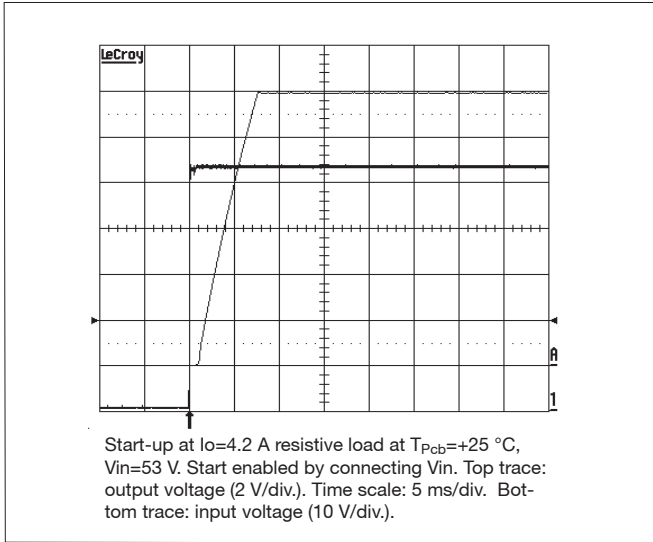

Turn-Off

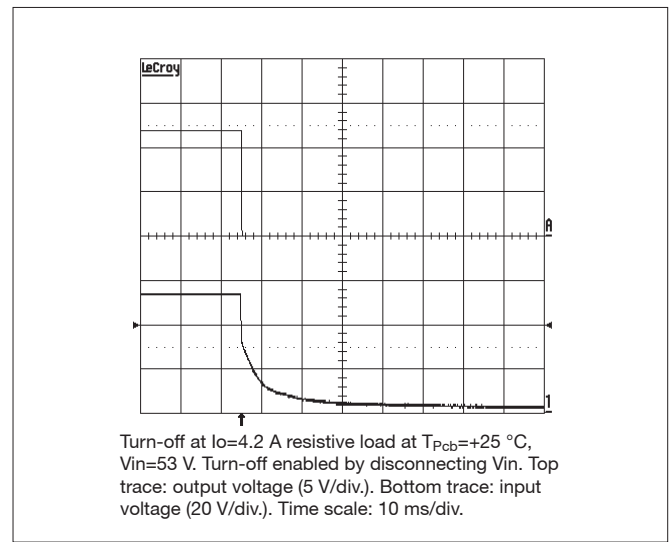

Output Ripple

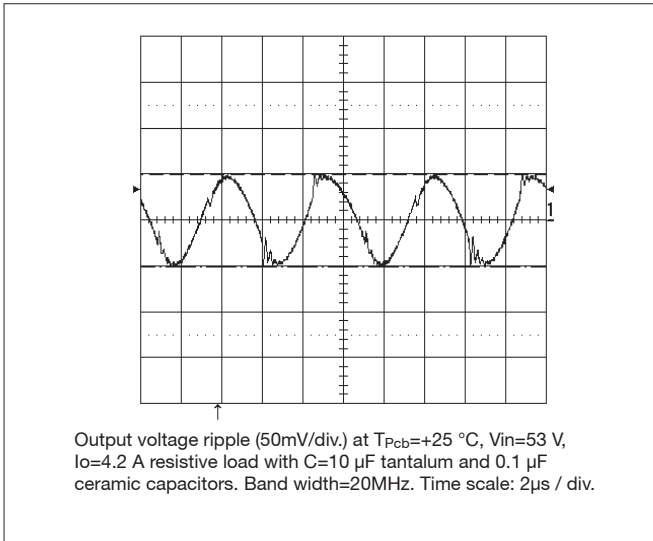

Transient

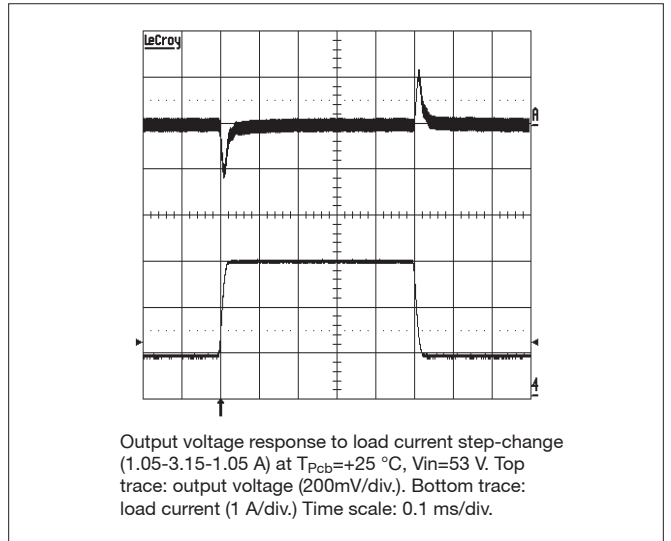

Output Voltage Adjust

The resistor value for an adjusted output voltage is calculated by using the following equations:

Output Voltage Adjust Upwards, Increase:

$$R_{adj} = 5.11 \left[\frac{12(100+\Delta\%)}{1.225\Delta\%} - \frac{(100+2\Delta\%)}{\Delta\%} \right] \text{ kOhm}$$

Output Voltage Adjust Downwards, Decrease:

$$R_{adj} = 5.11 \left[\frac{100}{\Delta\%} - 2 \right] \text{ kOhm}$$

Eg Increase 4% $\Rightarrow V_{out} = 12.48 V_{dc}$

$$5.11 \left[\frac{12(100+4)}{1.225 \times 4} - \frac{(100+2 \times 4)}{4} \right] = 1163.5 \text{ kOhm}$$

Eg Decrease 2% $\Rightarrow V_{out} = 11.76 V_{dc}$

$$5.11 \times \left(\frac{100}{2} - 2 \right) = 245.3 \text{ kOhm}$$

Output Voltage Adjust

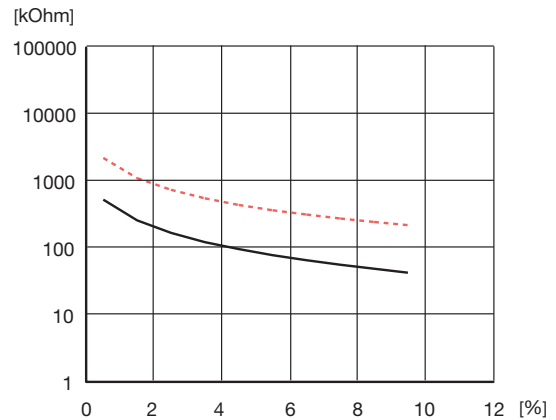

Output voltage adjust resistor value vs. percentage change in output voltage.

PKM 4515E PI Output

$T_{Pcb} = -40...+90\text{ °C}$ and $V_I = 36...75\text{V}$, sense pins connected to output pins unless otherwise specified.

Characteristics		Conditions	Output			Unit
			min	typ	max	
V_{O_i}	Output voltage initial setting and accuracy	I_{Omax} , $V_I = 53\text{ V}$, $T_{Pcb} = 25\text{ °C}$	14.75	15.0	15.25	V
	Output adjust range	I_{Omax} , $V_I = 53\text{ V}$, $T_{Pcb} = 25\text{ °C}$	13.5		16.5	V
V_O	Output voltage tolerance band	$I_O = (0.1...1.0) \times I_{Omax}$	14.70		15.30	V
	Idling voltage	$I_O = 0$	14.70		15.30	V
	Line regulation	I_{Omax}			10	mV
	Load regulation	$I_O = (0.01...1.0) \times I_{Omax}$, $V_I = 53\text{ V}$			10	mV
V_{tr}	Load transient voltage deviation	$I_O = (0.1...1.0) \times I_{Omax}$, $V_I = 53\text{ V}$, load step = $0.5 \times I_{Omax}$		± 300		mV
t_{tr}	Load transient recovery time	$I_O = (0.1...1.0) \times I_{Omax}$, $V_I = 53\text{ V}$, load step = $0.5 \times I_{Omax}$		100		μs
t_r	Ramp-up time	$I_O = (0.1...1.0) \times I_{Omax}$, $V_I = 53\text{ V}$ ($0.1...0.9$) $\times V_{Onom}$		5	10	ms
t_s	Start-up time	$I_O = (0.1...1.0) \times I_{Omax}$, $V_I = 53\text{ V}$ V_I connection to $0.9 \times V_{Onom}$		7.5	15	ms
I_O	Output current		0		3.33	A
P_{Omax}	Max output power	At $V_O = V_{Onom}$	50			W
I_{lim}	Current limit threshold	$T_{Pcb} < T_{Pcbmax}$		4.5		A
I_{sc}	Short circuit current	$T_{Pcb} = 25\text{ °C}$, $V_O < 0.5\text{V}$		7.5		A
V_{Oac}	Output ripple & noise	See ripple and noise, I_{Omax} , V_{Onom} ,		100	150	mV_{p-p}
SVR	Supply voltage rejection (ac)	$T_{Pcb} = 25\text{ °C}$, $f = 100\text{ Hz}$ sinewave, 1 Vpp , $V_I = 53\text{ V}$		70		dB
OVP	Over voltage protection	$V_I = 53\text{ V}$ $I_O = (0.1...1.0) \times I_{Omax}$	TBD		TBD	V

Miscellaneous

Characteristics		Conditions	min	typ	max	Unit
η	Efficiency - 50% load	$T_{Pcb} = +25\text{ °C}$, $V_I = 48\text{ V}$, $I_O = 0.5 \times I_{Omax}$		86.5		%
η	Efficiency - 100% load	$T_{Pcb} = +25\text{ °C}$, $V_I = 48\text{ V}$, $I_O = I_{Omax}$		90		%
η	Efficiency - 50% load	$T_{Pcb} = +25\text{ °C}$, $V_I = 53\text{ V}$, $I_O = 0.5 \times I_{Omax}$		86		%
η	Efficiency - 100% load	$T_{Pcb} = +25\text{ °C}$, $V_I = 53\text{ V}$, $I_O = I_{Omax}$	88	89.5		%
P_d	Power Dissipation	I_{Omax} , $V_I = 53\text{ V}$, $T_{Pcb} = 25\text{ °C}$		6		W
f_s	Switching frequency			200		kHz

PKM 4515E PI Typical Characteristics

Efficiency

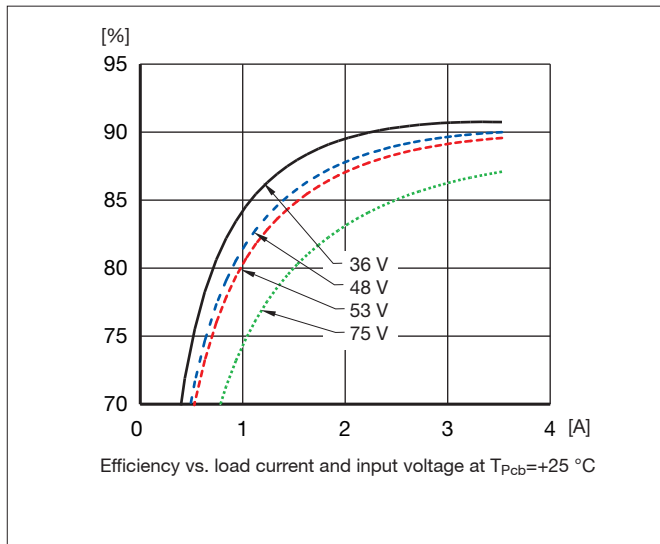

Output Current Derating

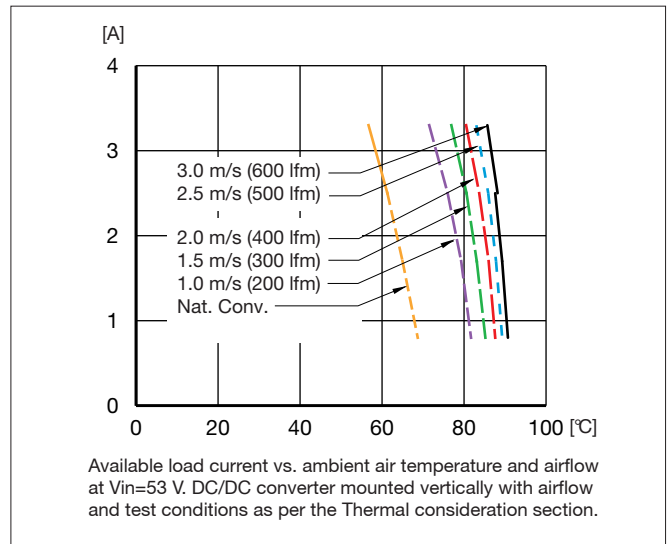

Power Dissipation

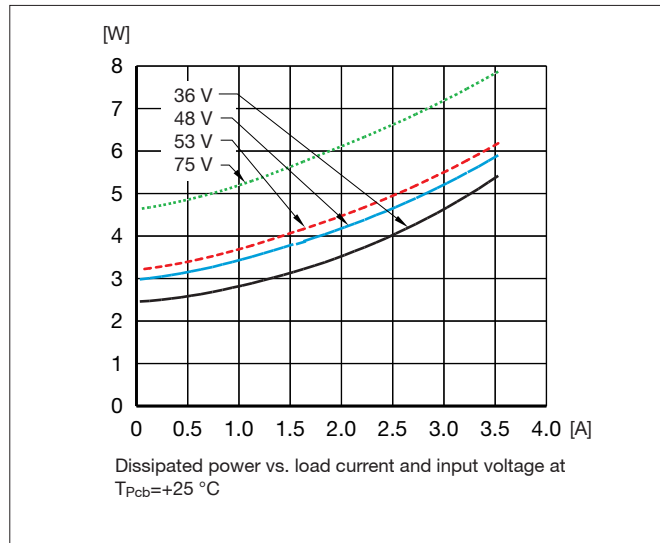

Thermal resistance

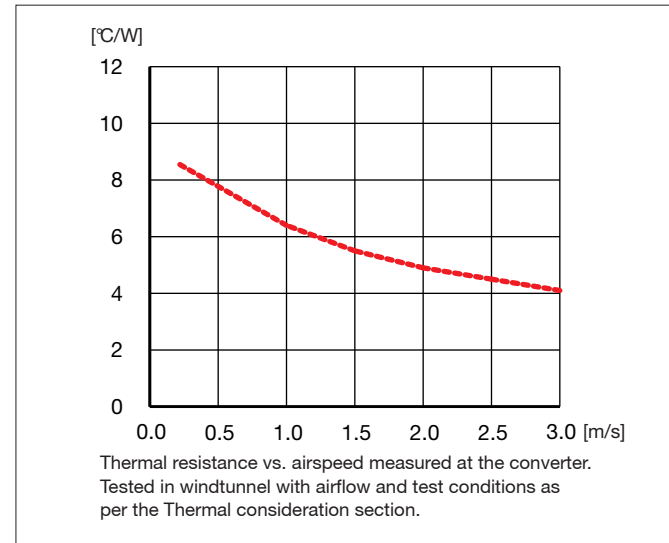

Output Characteristic

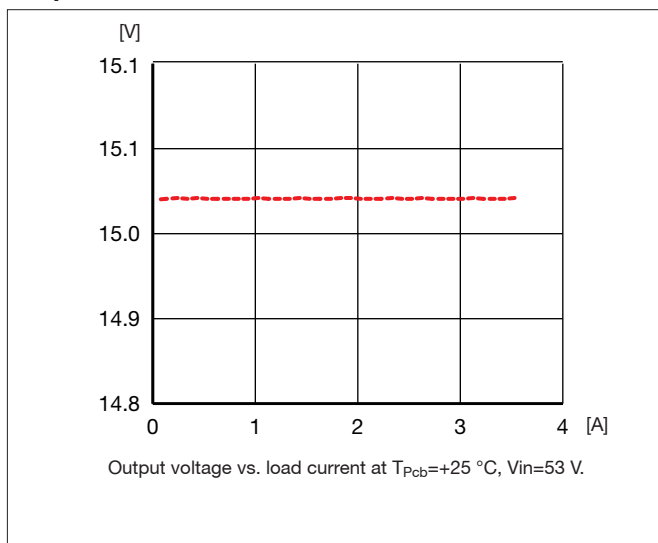

Heatsink (HS) option

The PKM4000E series DC/DC converters can be ordered with a heatsink (HS) option. The heatsink option have approximately 5 °C improved derating compared with the PKM4000E without heatsink. The HS option is intended to be mounted on a cold wall to transfer heat away from the converter.

PKM 4515E PI Typical Characteristics

Start-Up

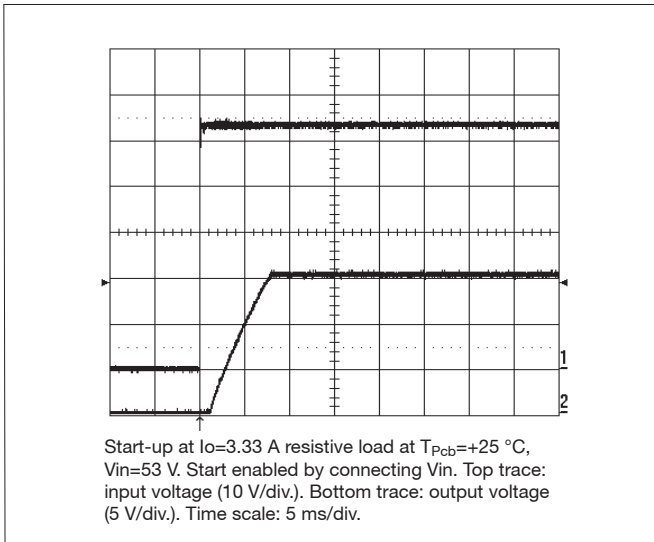

Turn-Off

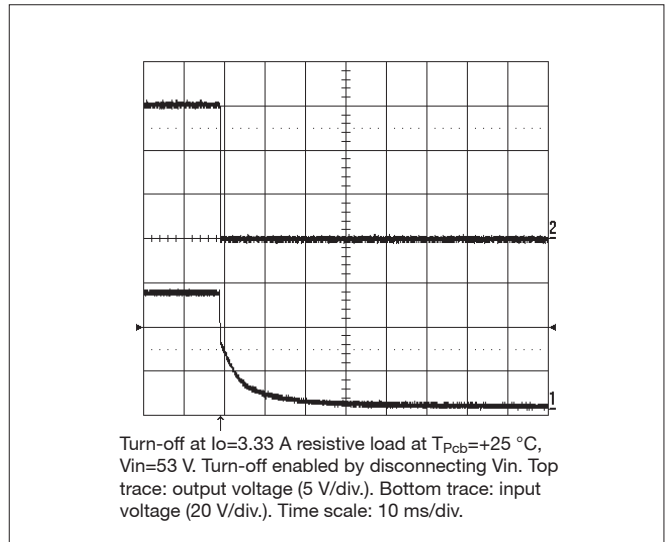

Output Ripple

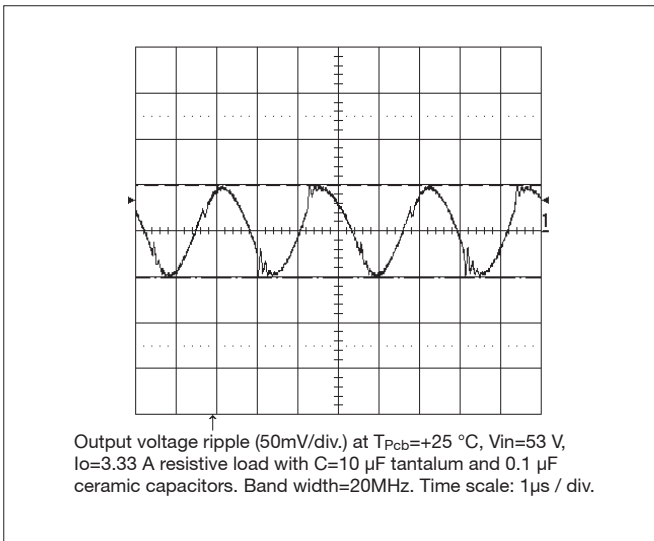

Transient

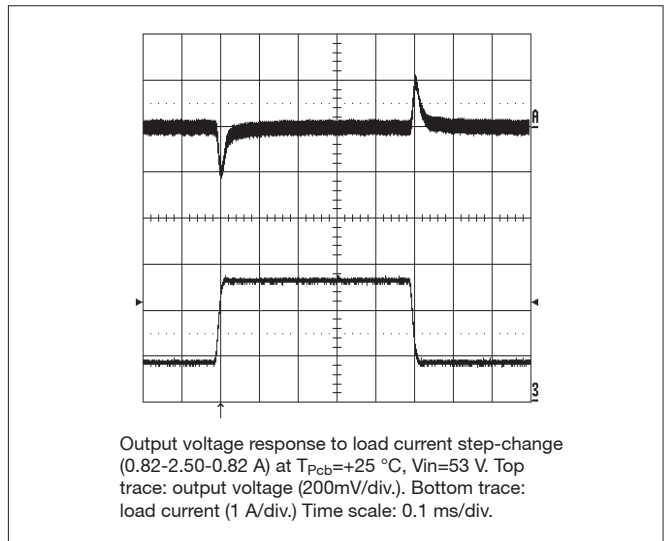

Output Voltage Adjust

The resistor value for an adjusted output voltage is calculated by using the following equations:

Output Voltage Adjust Upwards, Increase:

$$R_{adj} = 5.11 \left[\frac{15(100+\Delta\%)}{1.225\Delta\%} - \frac{(100+2\Delta\%)}{\Delta\%} \right] \text{ kOhm}$$

Output Voltage Adjust Downwards, Decrease:

$$R_{adj} = 5.11 \left[\frac{100}{\Delta\%} - 2 \right] \text{ kOhm}$$

Eg Increase 4% $\Rightarrow V_{out} = 15.6$ V_{dc}

$$5.11 \left[\frac{15(100+4)}{1.225 \times 4} - \frac{(100+2 \times 4)}{4} \right] = 1488.9 \text{ kOhm}$$

Eg Decrease 2% $\Rightarrow V_{out} = 14.7$ V_{dc}

$$5.11 \times \left(\frac{100}{2} - 2 \right) = 245.3 \text{ kOhm}$$

Output Voltage Adjust

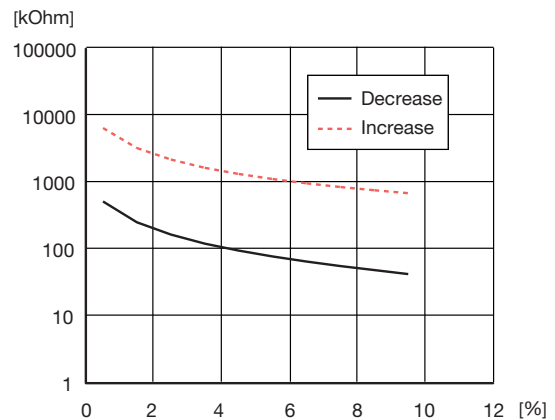

Output voltage adjust resistor value vs. percentage change in output voltage.

EMC Specification

The conducted EMI measurement was performed using a module placed directly on the test bench.
The fundamental switching frequency is 180 kHz for PKM4510E PI @ $V_I = 53V$, $I_O = (0.1...1.0) \times I_{Omax}$.

Conducted EMI Input terminal value (typ)

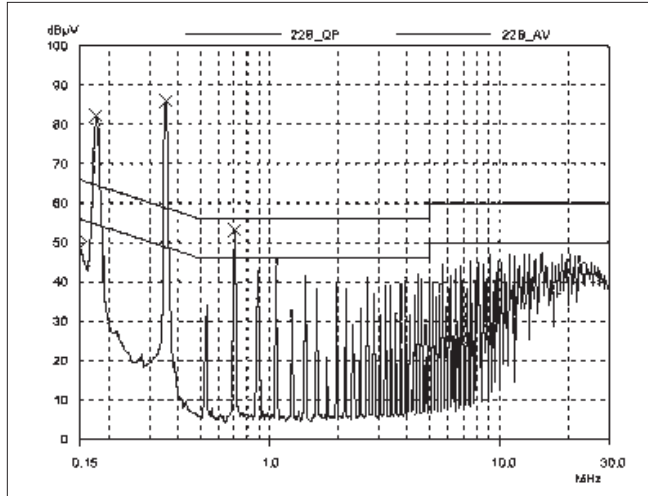

PKM 4510 E PI without filter

External filter (class B)

Required external input filter in order to meet class B in EN 55022, CISPR 22 and FCC part 15J.

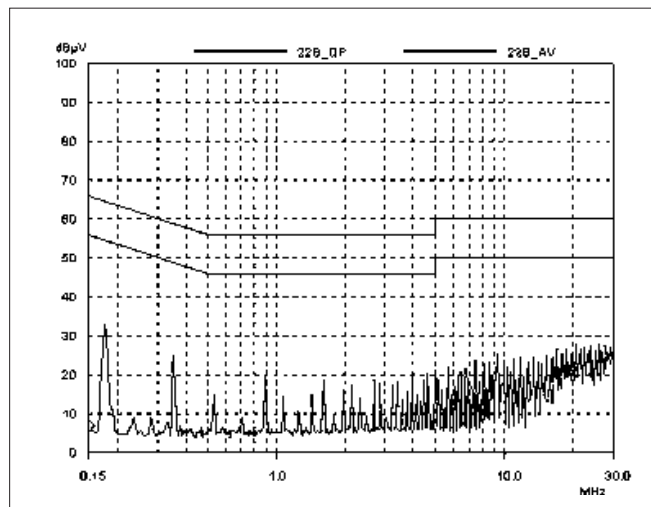
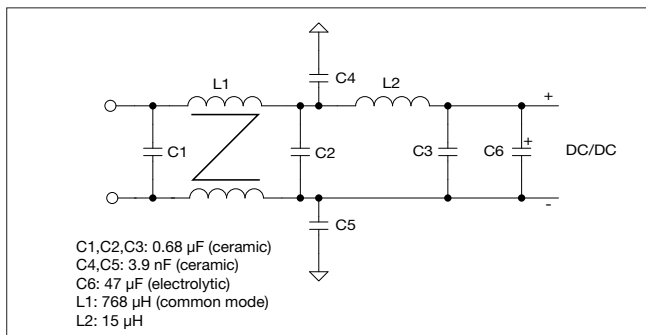

PKM 4510 E PI with filter

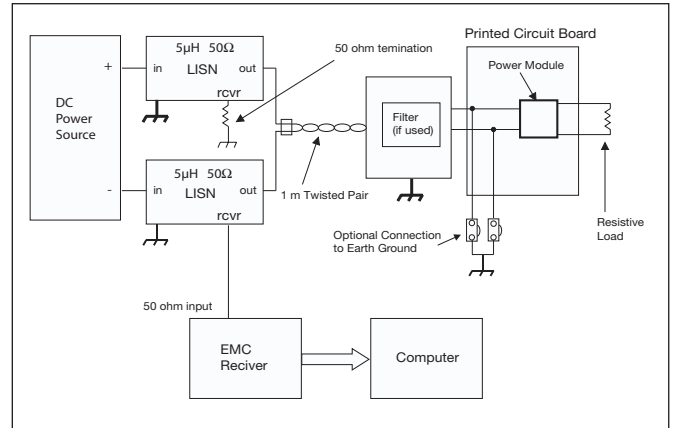

Test set-up.

Layout Recommendation

The radiated EMI performance of the DC/DC converter will be optimised by including a ground plane in the PCB area under the DC/DC converter. This approach will return switching noise to ground as directly as possible, with improvements to both emissions and susceptibility. It is also important to consider the stand-off of the PKM 4000E series DC/DC converter. If one ground trace is used, it should be connected to the input return. Alternatively, two ground traces may be used, with the trace under the input side of the DC/DC converter connected to the input return and the trace under the output side of the DC/DC converter connected to the output return. Make sure to use appropriate safety isolation spacing between these two return traces. The use of two traces as described will provide the capability of routing the input noise and output noise back to their respective returns.

Output ripple and noise

The circuit below has been used for the ripple and noise measurements on the PKM 4000E Series DC/DC converters.

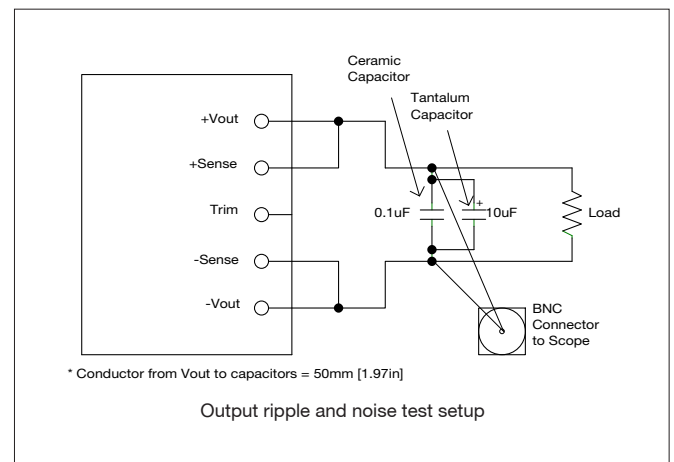

Operating Information

Input Voltage

The input voltage range 36...75Vdc meets the requirements of the European Telecom Standard ETS 300 132-2 for normal input voltage range in -48V and -60V DC systems, -40.5...-57.0V and -50.0...-72V respectively. At input voltages exceeding 75V, the power loss will be higher than at normal input voltage and T_{Pcb} must be limited to absolute max +110°C. The absolute maximum continuous input voltage is 80Vdc.

Turn-Off Input Voltage

The PKM 4000E Series DC/DC converters monitor the input voltage and will turn on and turn off at predetermined levels. The minimum hysteresis between turn on and turn off input voltage is 2V where the turn on input voltage is the highest.

Remote Control (RC)

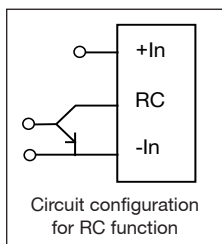

The PKM 4000E Series DC/DC converters have a remote control function referenced to the primary side (- In), with negative and positive logic options available. The RC function allows the converter to be turned on/off by an external device like a semiconductor or mechanical switch. The RC pin has an internal

pull up resistor to + In. The needed maximum sink current is 1mA. When the RC pin is left open, the voltage generated on the RC pin is 3.5 - 6 V. The maximum allowable leakage current of the switch is 50 μ A.

The standard converter is provided with “negative logic” remote control and the converter will be off until the RC pin is connected to the - In. To turn on the converter the voltage between RC pin and - In should be less than 1V. To turn off the converter the RC pin should be left open, or connected to a voltage higher than 4 V referenced to - In. In situations where it is desired to have the converter to power up automatically without the need for control signals or a switch, the RC pin can be wired directly to - In.

The second option is “positive logic” remote control, which can be ordered by adding the suffix “P” to the end of the part number. The converter will turn on when the input voltage is applied with the RC pin open. Turn off is achieved by connecting the RC pin to the - In. To ensure safe turn off the voltage difference between RC pin and the - In pin shall be less than 1V. The converter will restart automatically when this connection is opened.

Remote Sense

All PKM 4000E Series DC/DC converters have remote sense that can be used to compensate for moderate amounts of resistance in the distribution system and allow for voltage regulation at the load or other selected point. The remote sense lines will carry very little current and do not need a large cross sectional area. However, the sense lines on the PCB should be located close to a ground trace or ground plane. In a discrete wiring situation, the use of twisted pair wires or other technique to reduce noise susceptibility is highly recommended. The remote sense circuitry will compensate for up to 10% voltage drop between the sense voltage and the voltage at the output pins. The output voltage and the remote sense voltage offset must be less than the minimum over voltage trip point. If the remote sense is not needed the -Sense should be connected to -Out and +Sense should be connected to +Out.

Output Voltage Adjust (V_{adj})

All PKM 4000E Series DC/DC converters have an Output Voltage adjust pin (V_{adj}). This pin can be used to adjust the output voltage above or below Output voltage initial setting. When increasing the output voltage, the voltage at the output pins (including any remote sense offset) must be kept below the overvoltage trip point, to prevent the converter from shut down. Also note that at increased output voltages the maximum power rating of the converter remains the same, and the output current capability will decrease correspondingly. To decrease the output voltage the resistor should be connected between V_{adj} pin and -Sense pin. To increase the voltage the resistor should be connected between V_{adj} pin and +Sense pin. The resistor value of the Output voltage adjust function is according to information given under the output section.

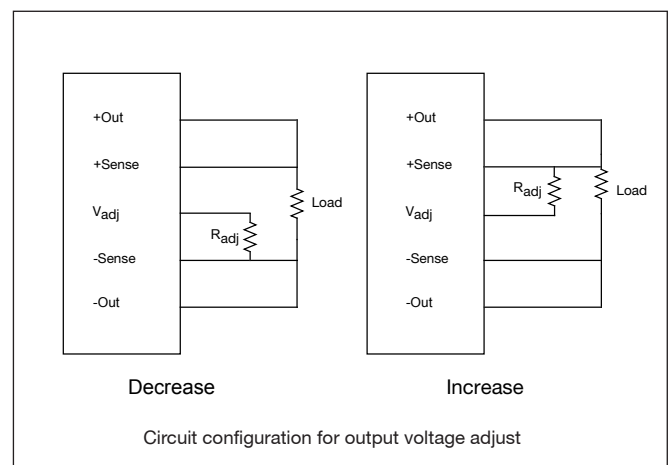

Operating Information

Current Limit Protection

The PKM 4000E Series DC/DC converters include current limiting circuitry that allows them to withstand continuous overloads or short circuit conditions on the output. The output voltage will decrease towards zero for output currents in excess of max output current (I_{omax}).

The converter will resume normal operation after removal of the overload. The load distribution system should be designed to carry the maximum output short circuit current specified.

Over Voltage Protection (OVP)

The PKM 4000E Series DC/DC converters have output over-voltage protection. In the event of an overvoltage condition, the converter will shut down immediately. The converter will make continuous attempts to start up (non-latching mode) and resume normal operation automatically.

Over Temperature Protection (OTP)

The PKM 4000E Series DC/DC converters are protected from thermal overload by an internal over temperature shutdown circuit. When the PCB temperature adjacent to the PWM control circuit exceeds 120 °C the converter will shut down immediately. The converter will make continuous attempts to start up (non-latching mode) and resume normal operation automatically when the temperature has dropped >10°C below the temperature threshold.

Input And Output Impedance

The impedance of both the power source and the load will interact with the impedance of the DC/DC converter. It is most important to have a ratio between L and C as low as possible, i.e. a low characteristic impedance, both at the input and output, as the converters have a low energy storage capability. The PKM 4000E Series DC/DC converters have been designed to be completely stable without the need for external capacitors on the input or the output circuits. The performance in some applications can be enhanced by addition of external capacitance as described under maximum capacitive load. If the distribution of the input voltage source to the converter contains significant inductance, the addition of a 100µF capacitor across the input of the converter will help insure stability. This capacitor is not required when powering the DC/DC converter from a low impedance source with short, low inductance, input power leads.

Maximum Capacitive Load

When powering loads with significant dynamic current requirements, the voltage regulation at the load can be improved by addition of decoupling capacitance at the load. The most affective technique is to locate low ESR ceramic capacitors as close to the load as possible, using several capacitors to lower the effective ESR. These ceramic capacitors will handle short duration high-frequency components of dynamic load changes. In addition, higher values of electrolytic capacitors should be used to handle the mid-frequency components. It is equally important to use good design practise when configuring the DC distribution system. Low resistance and low inductance PCB (printed circuit board) layouts and cabling should be used. Remember that when using remote sensing, all resistance, inductance and capacitance of the distribution system is within the feedback loop of the converter. This can affect on the converters compensation and the resulting stability and dynamic response performance. As a "rule of thumb", 100µF/A of output current can be used without any additional analysis. For example with a 25A converter, values of decoupling capacitance up to 2500 µF can be used without regard to stability. With larger values of capacitance, the load transient recovery time can exceed the specified value. As much of the capacitance as possible should be outside the remote sensing loop and close to the load. The absolute maximum value of output capacitance is 10 000 µF. For values larger than this, please contact your local Flex representative.

Parallel Operation

The PKM 4000E Series DC/DC converters can be paralleled for redundancy if external o-ring diodes are used in series with the outputs. It is not recommended to parallel the PKM 4000E Series DC/DC converters for increased power without using external current sharing circuits.

Thermal Consideration

General

The PKM 4000E Series DC/DC converters are designed to operate in a variety of thermal environments, however sufficient cooling should be provided to help ensure reliable operation. Heat is removed by conduction, convection and radiation to the surrounding environment. Increased airflow enhances the heat transfer via convection. The available load current vs. ambient air temperature and airflow at $V_{in}=53\text{ V}$ for each model is according to the information given under the output section. The test is done in a wind tunnel with a cross section of 305x305mm, the DC/DC converter vertically mounted on a 8 layer PCB with a size of 254x254mm. Proper cooling can be verified by measuring the temperature of selected devices. Peak temperature can occur at position P1 and P2. The temperature at these positions should not exceed the recommended max values.

Position	Device	T _{critical}	Max Value
P1	Transformer	T _{core}	110°C
P2	Mosfet	T _{surface}	110°C

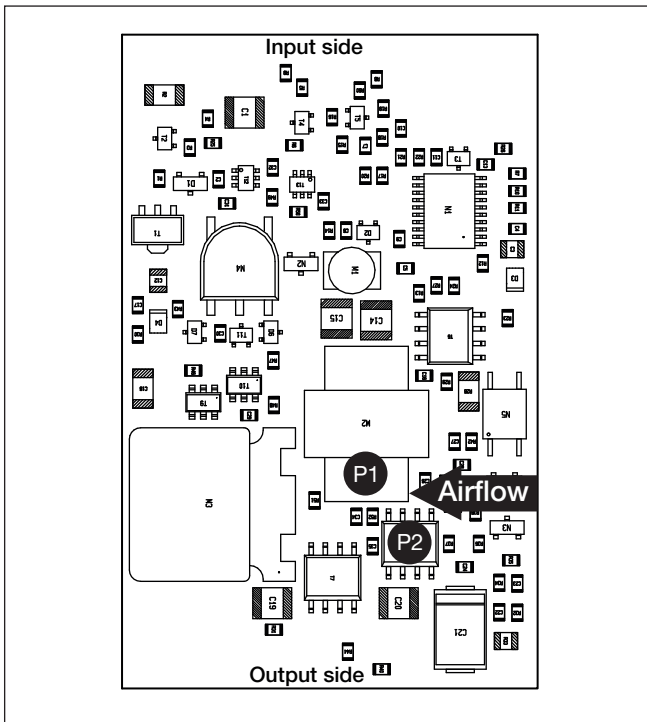

Calculation of ambient temperature

By using the thermal resistance the maximum allowed ambient temperature can be calculated.

- The powerloss is calculated by using the formula $((1/\eta) - 1) \times \text{output power} = \text{power losses}$.
 η = efficiency of converter. E.g 89% = 0.89
- Find the value of the thermal resistance for each product in the diagram by using the airflow speed at the output section of the converter. Take the thermal resistance x powerloss to get the temperature increase.
- Max allowed calculated ambient temperature is: Max T_{PCB} of DC/DC converter – temperature increase.
 E.g PKM 4510E PI at 1m/s:
 A. $((\frac{1}{0.89}) - 1) \times 49.5\text{W} = 6.1\text{W}$
 B. $6.1\text{W} \times 5.5^\circ\text{C/W} = 33.6^\circ\text{C}$
 C. $110^\circ\text{C} - 33.6^\circ\text{C} = \text{max ambient temperature is } 76.4^\circ\text{C}$

The real temperature will be dependent on several factors, like PCB size and type, direction of airflow, air turbulence etc. It is recommended to verify the temperature by testing.

Soldering Information

The PKM4000E Series DC/DC converters are intended for through hole mounting on a PCB. When wave soldering is used max temperature on the pins is specified to 260°C for 10 seconds. Maximum preheat rate of 4°C/s and temperature of max 130°C is suggested. When hand soldering, care should be taken to avoid direct contact between the hot soldering iron tip and the pins for more than a few seconds in order to prevent overheating.

No-clean flux is recommended to avoid entrapment of cleaning fluids in cavities inside of the DC/DC power module. The residues may affect long time reliability and isolation voltage.

Delivery Package Information

PKM 4000E series standard delivery packages are 100 or 20 pcs boxes (One box contains 5 or 1 full tray(s) and 1 empty hold down tray).

Tray Specification

Material:	Polystyrene (PS)
Max surface resistance:	10 MOhm/sq
Color:	Black
Capacity:	20 pcs/tray
Loaded tray stacking pitch:	16.2 mm (0.64 In)
Weight:	133 g

Compatibility with RoHS requirements

The products are compatible with the relevant clauses and requirements of the RoHS directive 2002/95/EC and have a maximum concentration value of 0.1% by weight in homogeneous materials for lead, mercury, hexavalent chromium, PBB and PBDE and of 0.01% by weight in homogeneous materials for cadmium.

Exemptions in the RoHS directive utilized in Flex products include:

- Lead in high melting temperature type solder (used to solder the die in semiconductor packages)
- Lead in glass of electronics components and in electronic ceramic parts (e.g. fill material in chip resistors)
- Lead as an alloying element in copper alloy containing up to 4% lead by weight (used in connection pins made of Brass)

Reliability

The Mean Time Between Failure (MTBF) of the PKM4000E Series DC/DC converter is calculated at full output power and an operating ambient temperature (TA) of +40°C. Different methods could be used to calculate the predicted MTBF and failure rate which may give different results. Flex currently uses two different methods, Ericsson failure rate data system DependTool and Telcordia SR332.



Predicted MTBF for the PKM4000E Series products is:

- 7.0 million hours according to DependTool.
- 1.6 million hours according to Telcordia SR332, issue 1, Black box technique.







The Flex failure rate data system is based on field tracking data. The data corresponds to actual failure rates of components used in Information Technology and Telecom (IT&T) equipment in temperature controlled environments (TA = -5...+65°C). Telcordia SR332 is a commonly used standard method intended for reliability calculations in IT&T equipment. The parts count procedure used in this method was originally modeled on the methods from MIL-HDBK-217F, Reliability Predictions of Electronic Equipment. It assumes that no reliability data is available on the actual units and devices for which the predictions are to be made, i.e. all predictions are based on generic reliability parameters.equipment. For more information please refer to Design Note 002.

Looking for pricing, stock, or lifecycle information?

Click below to explore more details on WIN SOURCE:

-  [View PKM4510EPI on WIN SOURCE](#)
-  [Flex Power Modules Information](#)

Optimize Your Supply Chain with WIN SOURCE Solutions

-  Global Sourcing Solution
-  Obsolete Management
-  Cost Control Management
-  Shortage Management
-  Alternative Solution
-  Excess Inventory Management