



# THE DATASHEET OF HMC752LC4





## GaAs HEMT MMIC LOW NOISE AMPLIFIER, 24 - 28 GHz

### Typical Applications

This HMC752LC4 is ideal for:

- Point-to-Point Radios
- Point-to-Multi-Point Radios
- Military & Space
- Test Instrumentation

### Features

- Noise Figure: 2.5 dB
- Gain: 25 dB
- P1dB Output Power: +13 dBm
- Supply Voltage: +3V @ 70 mA
- Output IP3: +26 dBm
- 50 Ohm matched Input/Output
- 24 Lead Ceramic 4x4mm SMT Package: 16mm<sup>2</sup>

### Functional Diagram

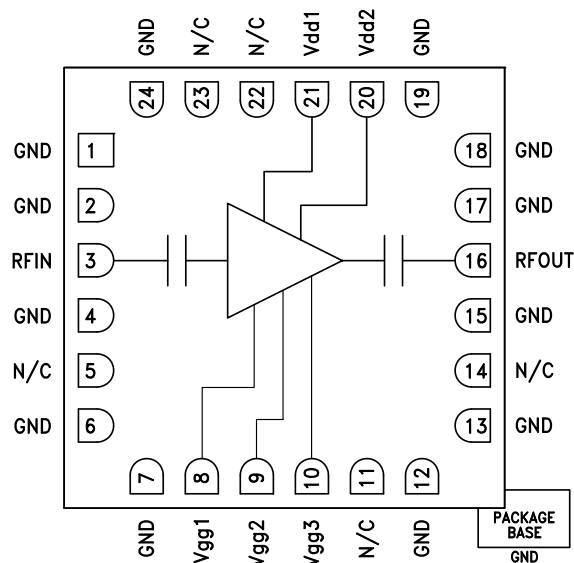

### General Description

The HMC752LC4 is a GaAs MMIC Low Noise Wide-band Amplifier housed in a leadless 4x4 mm ceramic surface mount package. The amplifier operates between 24 and 28 GHz, providing up to 25 dB of small signal gain, 2.5 dB noise figure, and output IP3 of +26 dBm, while requiring only 70 mA from a +3V supply. The P1dB output power of up to +13 dBm enables the LNA to function as a LO driver for balanced, I/Q or image reject mixers. The HMC752LC4 also features I/Os that are DC blocked and internally matched to 50 Ohms, making it ideal for high capacity microwave radios or VSAT applications.

### Electrical Specifications, $T_A = +25^\circ C$ , $V_{dd} = V_{dd1} = V_{dd2} = +3V$ , $I_{dd} = I_{dd1} + I_{dd2} = 70 mA$ <sup>[2]</sup>

Parameter	Min.	Typ.	Max.	Units
Frequency Range		24 - 28		GHz
Gain <sup>[1]</sup>	23	25		dB
Gain Variation over Temperature		0.02		dB / °C
Noise Figure <sup>[1]</sup>		2.5	3	dB
Input Return Loss		14		dB
Output Return Loss		14		dB
Output Power for 1 dB Compression <sup>[1]</sup>		13		dBm
Saturated Output Power (P <sub>sat</sub> ) <sup>[1]</sup>		16		dBm
Output Third Order Intercept (IP3)		26		dBm
Supply Current (I <sub>dd</sub> ) (V <sub>dd</sub> = 3V, V <sub>gg</sub> = V <sub>gg1</sub> = V <sub>gg2</sub> = V <sub>gg3</sub> = -0.3V Typ.)		70		mA

[1] Board loss subtracted out for gain, power and noise figure measurement

[2] Adjust V<sub>gg</sub> = between -1 to 0.3V to achieve I<sub>dd</sub> = 70mA



**GaAs HEMT MMIC LOW NOISE AMPLIFIER, 24 - 28 GHz**

**Gain vs. Temperature**

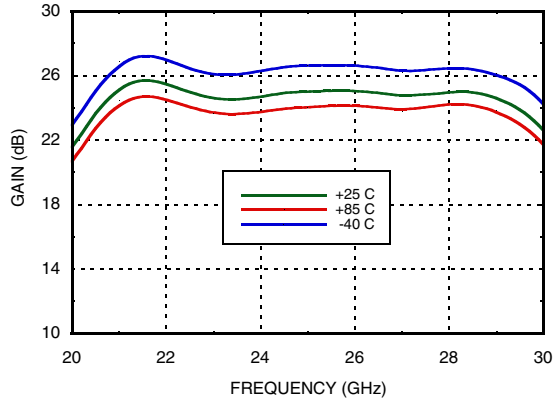

**Gain vs. I<sub>dd</sub>**

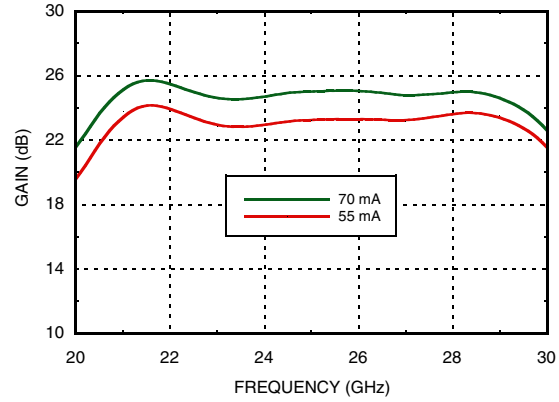

**Input Return Loss vs. Temperature**

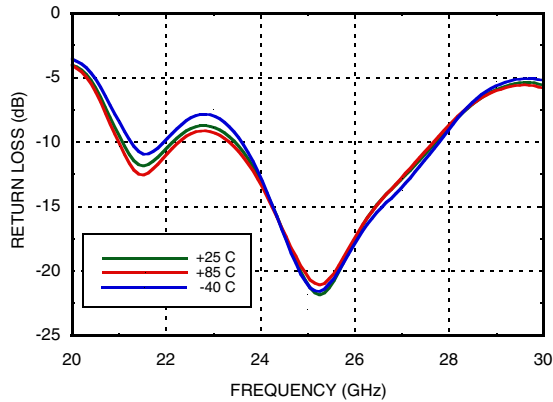

**Output Return Loss vs. Temperature**

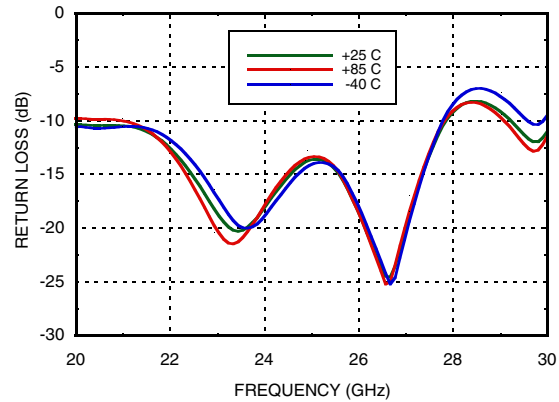

**Noise Figure vs. Temperature**

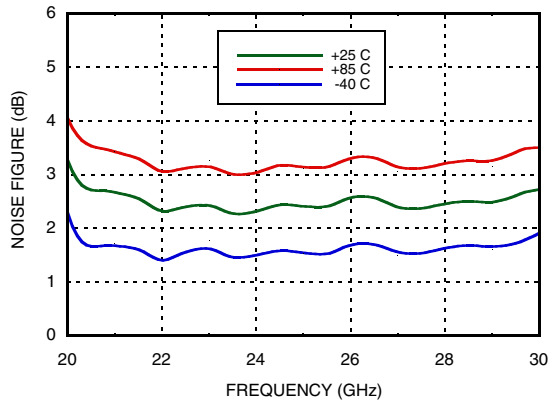

**Noise Figure vs. I<sub>dd</sub>**

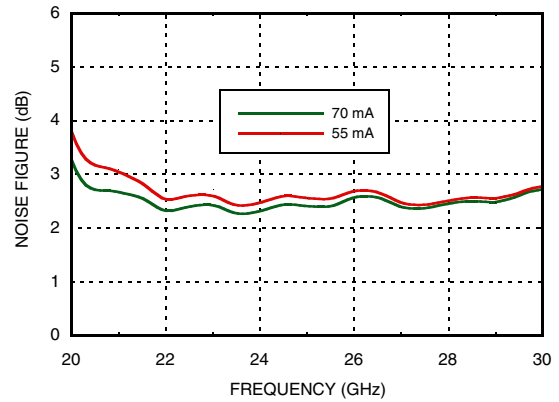



**GaAs HEMT MMIC LOW NOISE AMPLIFIER, 24 - 28 GHz**

**Output IP3 vs. Temperature**

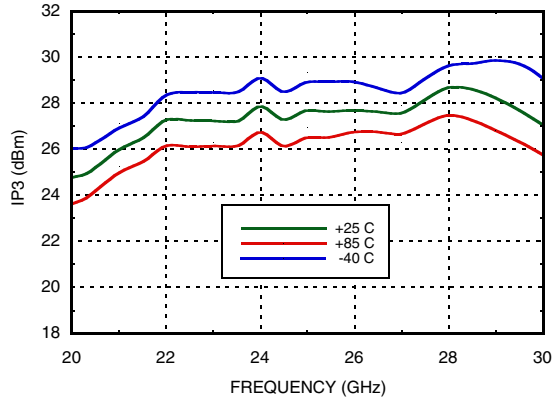

**Output IP3 vs. Idd**

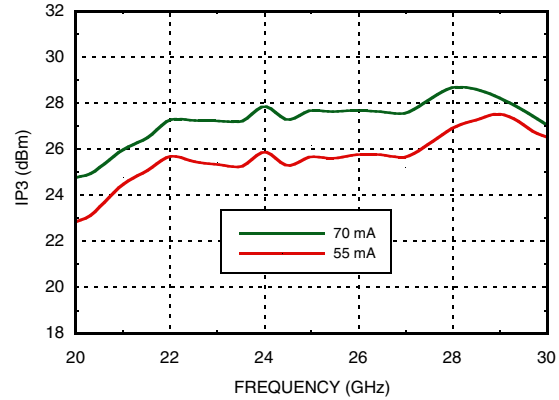

**P1dB vs. Temperature**

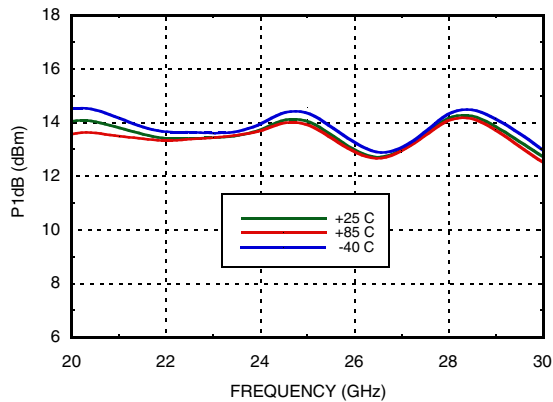

**P1dB vs. Idd**

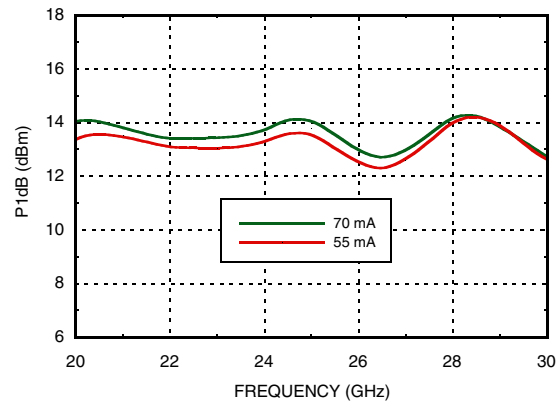

**Psat vs. Temperature**

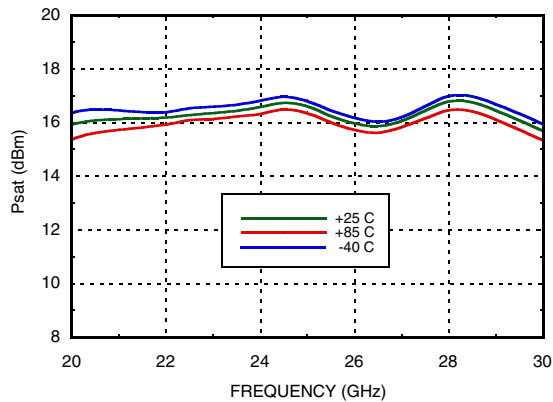

**Reverse Isolation vs. Temperature**

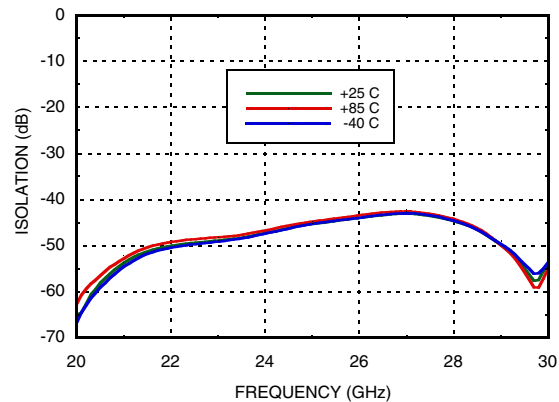



## GaAs HEMT MMIC LOW NOISE AMPLIFIER, 24 - 28 GHz

### Power Compression @ 28 GHz

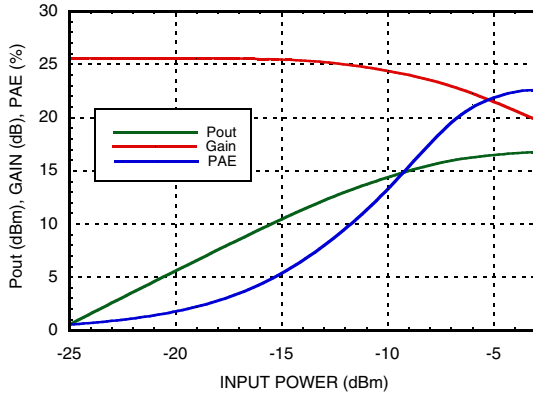

### Gain, Noise Figure & P1dB vs. Supply Voltage @ 28 GHz

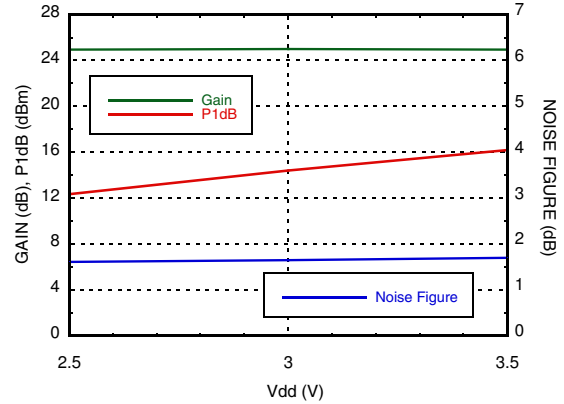

### Absolute Maximum Ratings

Drain Bias Voltage	+4.5V
RF Input Power	+12 dBm
Gate Bias Voltage	-1 to 0.3V
Channel Temperature	175 °C
Continuous P <sub>diss</sub> (T = 85 °C) (derate 6.7 mW/°C above 85 °C)	0.21 W
Thermal Resistance (Channel to ground paddle)	148 °C/W
Storage Temperature	-65 to +150 °C
Operating Temperature	-40 to +85 °C



ELECTROSTATIC SENSITIVE DEVICE  
OBSERVE HANDLING PRECAUTIONS



**GaAs HEMT MMIC LOW NOISE  
AMPLIFIER, 24 - 28 GHz**

**Outline Drawing**

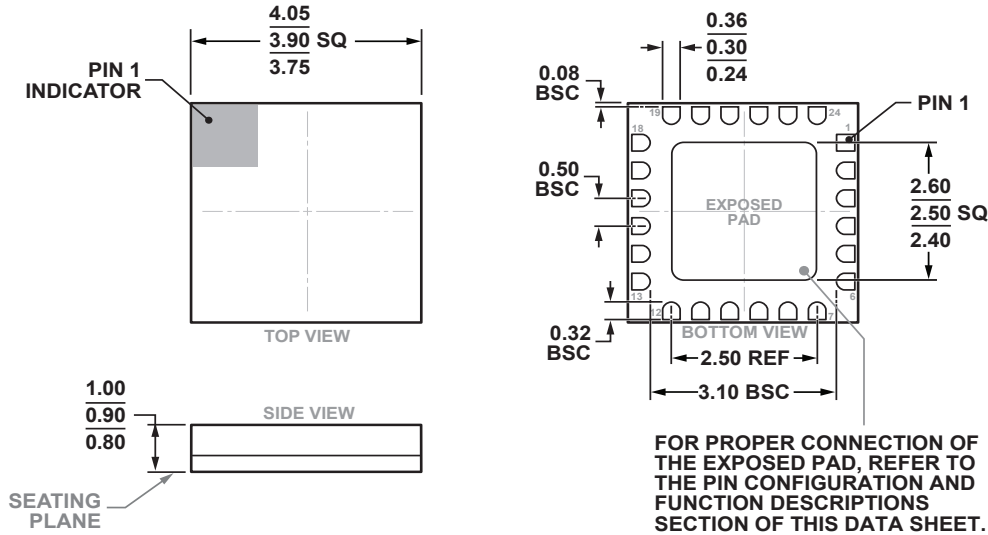

02-27-2017-B

24-Terminal Ceramic Leadless Chip Carrier [LCC]  
(E-24-1)  
Dimensions shown in millimeters.

**Package Information**

Part Number	Package Body Material	Lead Finish	MSL Rating	Package Marking <sup>[2]</sup>
HMC752LC4	Alumina, White	Gold over Nickel	MSL3 <sup>[1]</sup>	H752 XXXX

[1] Max peak reflow temperature of 260 °C

[2] 4-Digit lot number XXXX



**GaAs HEMT MMIC LOW NOISE AMPLIFIER, 24 - 28 GHz**

**Pin Descriptions**

Pin Number	Function	Description	Interface Schematic
1, 2, 4, 6, 7, 12, 13, 15, 17 - 19, 24	GND	Package bottom has exposed metal paddle that must be connected to RF/DC ground.	
3	RFIN	This pad is AC coupled and matched to 50 Ohms.	
5, 11, 14, 22, 23	N/C	No Connection. This pin may be connected to RF/DC ground. Performance will not be affected.	
8 - 10	Vgg1 - 3	Gate control for amplifier. Please follow "MMIC Amplifier Biasing Procedure" application note. See assembly for required external components.	
16	RFOUT	This pad is AC coupled and matched to 50 Ohms.	
21, 20	Vdd1, Vdd2	Power Supply Voltage for the amplifier. See assembly for required external components.	

**Application Circuit**

Component	Value
C1 - C5	100 pF
C6 - C10	1,000 pF
C11 - C15	4.7 μF

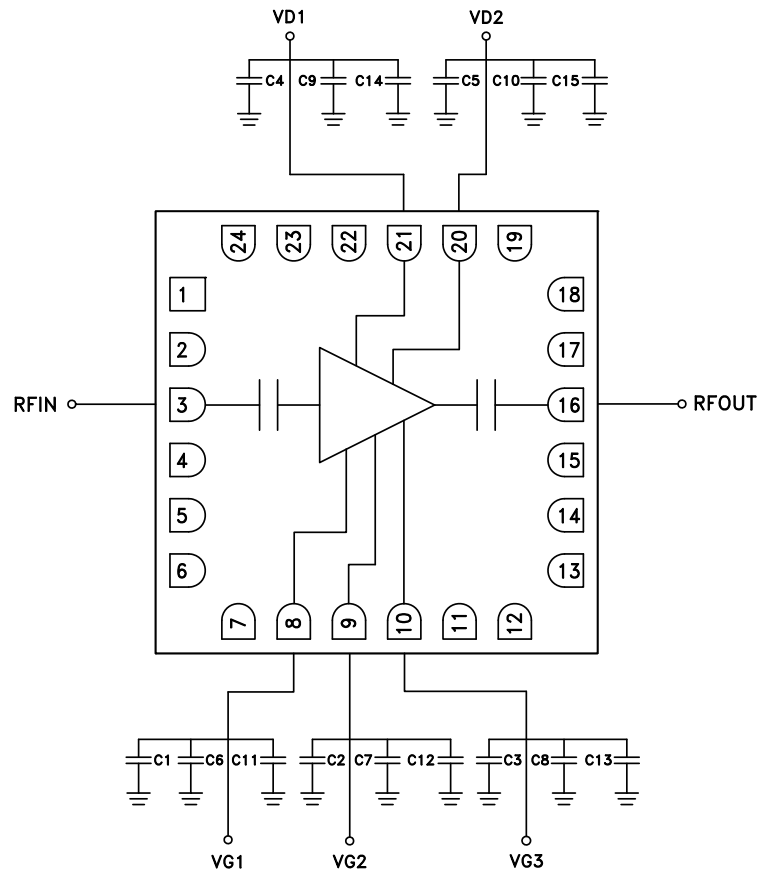



**GaAs HEMT MMIC LOW NOISE  
AMPLIFIER, 24 - 28 GHz**

**Evaluation PCB**

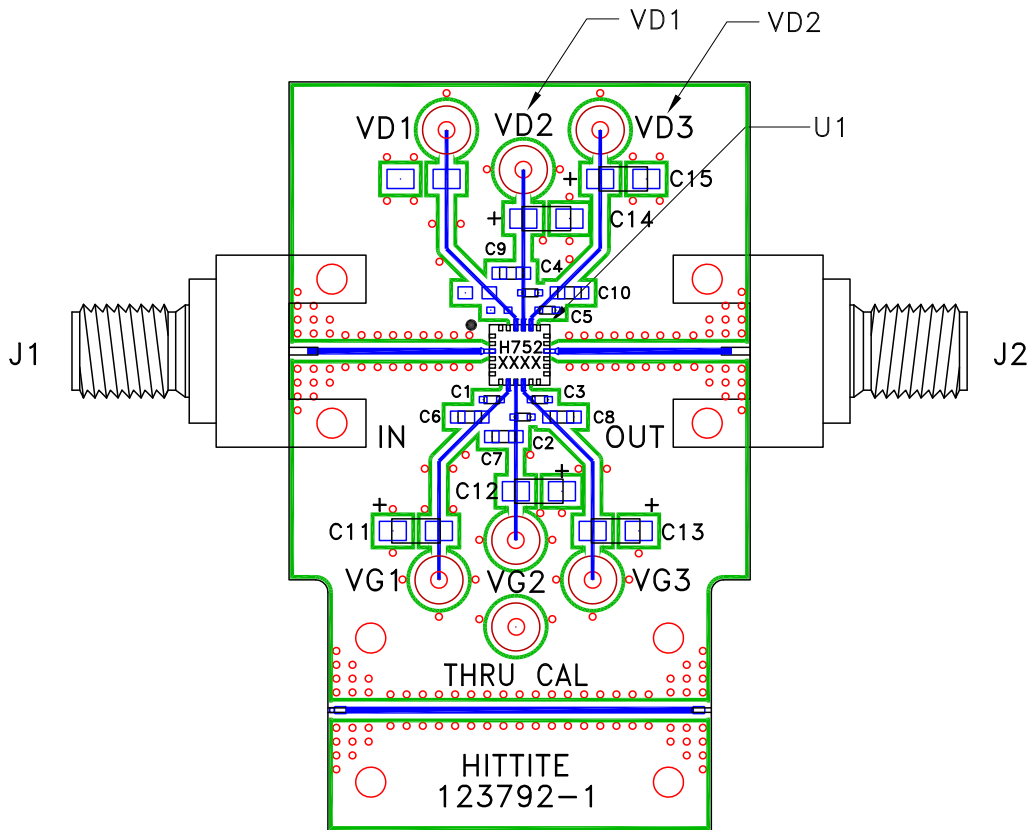

**List of Materials for Evaluation PCB 123794 [1]**

Item	Description
J1, J2	2.92mm PCB mount K-Connector
J3 - J9	DC Pin
C1 - C5	100pF Capacitor, 0402 Pkg.
C6 - C10	1,000pF Capacitor, 0603 Pkg.
C11 - C15	4.7 $\mu$ F Capacitor, Tantalum
U1	HMC752LC4 Amplifier
PCB [2]	123792 Evaluation PCB [2]

[1] Reference this number when ordering complete evaluation PCB

[2] Circuit Board Material: Rogers 4350 or Arlon 25FR

The circuit board used in this application should use RF circuit design techniques. Signal lines should have 50 Ohm impedance while the package ground leads and exposed paddle should be connected directly to the ground plane similar to that shown. A sufficient number of via holes should be used to connect the top and bottom ground planes. The evaluation board should be mounted to an appropriate heat sink. The evaluation circuit board shown is available from Analog Devices upon request.

## Looking for pricing, stock, or lifecycle information?

Click below to explore more details on WIN SOURCE:

 [View HMC752LC4 on WIN SOURCE](#)

 [Analog Devices Inc. Information](#)

## Optimize Your Supply Chain with WIN SOURCE Solutions

-  Global Sourcing Solution
-  Obsolete Management
-  Cost Control Management
-  Shortage Management
-  Alternative Solution
-  Excess Inventory Management