

FEATURES

Output frequency range: 400 MHz to 6 GHz
1 dB output compression: ≥ 9.4 dBm from 450 MHz to 4 GHz
Output return loss ≤ 12 dB from 450 MHz to 4.5 GHz
Noise floor: -160 dBm/Hz at 900 MHz
Sideband suppression: ≤ -50 dBc at 900 MHz
Carrier feedthrough: ≤ -40 dBm at 900 MHz
IQ3dB bandwidth: ≥ 750 MHz
Baseband input bias level
 ADL5375-05: 500 mV
 ADL5375-15: 1500 mV
Single supply: 4.75 V to 5.25 V
24-lead LFCSP_VQ package

APPLICATIONS

Cellular communication systems
 GSM/EDGE, CDMA2000, W-CDMA, TD-SCDMA
WiMAX/LTE broadband wireless access systems
Satellite modems

GENERAL DESCRIPTION

The **ADL5375** is a broadband quadrature modulator designed for operation from 400 MHz to 6 GHz. Its excellent phase accuracy and amplitude balance enable high performance intermediate frequency or direct radio frequency modulation for communication systems.

The **ADL5375** features a broad baseband bandwidth, along with an output gain flatness that varies no more than 1 dB from 450 MHz to 3.5 GHz. These features, coupled with a broadband output return loss of ≤ -12 dB, make the **ADL5375** ideally suited for broadband zero IF or low IF-to-RF applications,

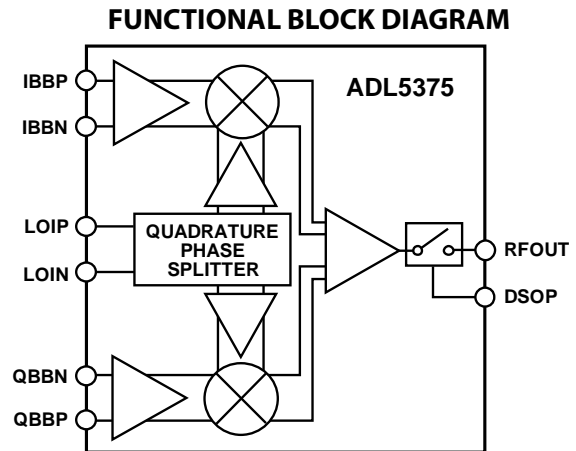

Figure 1.

broadband digital predistortion transmitters, and multiband radio designs.

The **ADL5375** accepts two differential baseband inputs and a single-ended LO. It generates a single-ended 50 Ω output. The two versions offer input baseband bias levels of 500 mV (**ADL5375-05**) and 1500 mV (**ADL5375-15**).

The **ADL5375** is fabricated using an advanced silicon-germanium bipolar process. It is available in a 24-lead, exposed paddle, lead-free, LFCSP_VQ package. Performance is specified over a -40°C to $+85^{\circ}\text{C}$ temperature range. A lead-free evaluation board is also available.

TABLE OF CONTENTS

| | | | |
|---|----|--|----|
| Features | 1 | LO Input | 20 |
| Applications | 1 | RF Output | 20 |
| Functional Block Diagram | 1 | Output Disable | 21 |
| General Description | 1 | Applications Information | 22 |
| Revision History | 2 | Carrier Feedthrough Nulling | 22 |
| Specifications | 3 | Sideband Suppression Optimization | 22 |
| Absolute Maximum Ratings | 7 | Interfacing the ADF4350 PLL to the ADL5375 | 23 |
| ESD Caution | 7 | DAC Modulator Interfacing | 24 |
| Pin Configuration and Function Descriptions | 8 | GSM/EDGE Operation | 27 |
| Typical Performance Characteristics | 9 | W-CDMA Operation | 28 |
| ADL5375-05 | 9 | LO Generation Using PLLs | 29 |
| ADL5375-15 | 14 | Transmit DAC Options | 29 |
| Theory of Operation | 19 | Modulator/Demodulator Options | 29 |
| Circuit Description | 19 | Evaluation Board | 30 |
| Basic Connections | 20 | Characterization Setup | 33 |
| Power Supply and Grounding | 20 | Outline Dimensions | 35 |
| Baseband Inputs | 20 | Ordering Guide | 35 |

REVISION HISTORY

6/14—Rev. C to Rev. D

| | |
|--|----|
| Changes to Figure 2 | 8 |
| Changes to Figure 13, Figure 14, and Figure 15 | 10 |
| Changes to Figure 38, Figure 39, and Figure 40 | 15 |
| Changes to Table 9 | 31 |
| Changes to Ordering Guide | 35 |

7/13—Rev. B to Rev. C

| | |
|----------------------------------|-----------|
| Changed CP-24-3 to CP-24-7 | Universal |
|----------------------------------|-----------|

9/11—Rev. A to Rev. B

| | |
|--|----|
| Changes to Features Section | 1 |
| Replaced Table 1 | 3 |
| Changes to Typical Performance Characteristics Section | 9 |
| Updated Output Disable Section | 21 |

| | |
|--|----|
| Changes to Application Information Section | 22 |
| Changes to Evaluation Board Section | 30 |
| Changes to Figure 80 | 34 |
| Added Exposed Pad Notation to Outline Dimensions | 35 |

11/08—Rev. 0 to Rev. A

| | |
|--|-----------|
| Change AD9779 to AD9779A | Universal |
| Added Endnote, I/Q Input Bias Level and Absolute Voltage Level Parameters, Table 1 | 6 |
| Added Absolute Voltage Level Parameter, Table 1 | 6 |

12/07—Revision 0: Initial Version

SPECIFICATIONS

$V_S = 5\text{ V}$; $T_A = 25^\circ\text{C}$; LO = 0 dBm single-ended drive; baseband I/Q amplitude = 1 V p-p differential sine waves in quadrature with a 500 mV (ADL5375-05) or 1500 mV (ADL5375-15) dc bias; baseband I/Q frequency (f_{BB}) = 1 MHz, unless otherwise noted.

Table 1.

| Parameter | Conditions | ADL5375-05 | | | ADL5375-15 | | | Unit |
|---------------------------|--|------------|--------|-----|------------|-----|-----|---------|
| | | Min | Typ | Max | Min | Typ | Max | |
| OPERATING FREQUENCY RANGE | | | | | | | | |
| Low frequency | | | 400 | | 400 | | | MHz |
| High frequency | | | 6000 | | 6000 | | | MHz |
| LO = 450 MHz | | | | | | | | |
| Output Power, P_{OUT} | $V_{IQ} = 1\text{ V p-p differential}$ | | 0.85 | | 0.47 | | | dBm |
| Modulator Voltage Gain | RF output divided by baseband input voltage | | -3.1 | | -3.5 | | | dB |
| Output P1dB | | | 9.6 | | 10 | | | dBm |
| Output Return Loss | | | -16.4 | | -15.2 | | | dB |
| Carrier Feedthrough | | | -47.5 | | -42.5 | | | dBm |
| Sideband Suppression | | | -37.6 | | -38 | | | dBc |
| Quadrature Error | | | 1.7 | | 1.49 | | | Degrees |
| I/Q Amplitude Balance | | | 0.07 | | 0.10 | | | dB |
| Second Harmonic | $P_{OUT} - (f_{LO} + (2 \times f_{BB}))$ | | -75.9 | | -81.5 | | | dBc |
| ADL5375-05 | $P_{OUT} = 0.85\text{ dBm}$ | | | | | | | |
| ADL5375-15 | $P_{OUT} = 0.47\text{ dBm}$ | | | | | | | |
| Third Harmonic | $P_{OUT} - (f_{LO} + (3 \times f_{BB}))$ | | -51.5 | | -81.6 | | | dBc |
| ADL5375-05 | $P_{OUT} = 0.85\text{ dBm}$ | | | | | | | |
| ADL5375-15 | $P_{OUT} = 0.47\text{ dBm}$ | | | | | | | |
| Output IP2 | $f_{1BB} = 3.5\text{ MHz}$, $f_{2BB} = 4.5\text{ MHz}$, baseband I/Q amplitude per tone = 0.5 V p-p differential | | 65.4 | | 64.7 | | | dBm |
| Output IP3 | $f_{1BB} = 3.5\text{ MHz}$, $f_{2BB} = 4.5\text{ MHz}$, baseband I/Q amplitude per tone = 0.5 V p-p differential | | 26.6 | | 23.6 | | | dBm |
| Noise Floor | I/Q inputs = 0 V differential with a dc bias only, 20 MHz carrier offset | | -160.5 | | -157.0 | | | dBm/Hz |
| LO = 900 MHz | | | | | | | | |
| Output Power, P_{OUT} | $V_{IQ} = 1\text{ V p-p differential}$ | | 0.75 | | 0.41 | | | dBm |
| Modulator Voltage Gain | RF output divided by baseband input voltage | | -3.2 | | -3.5 | | | dB |
| Output P1dB | | | 9.6 | | 10 | | | dBm |
| Output Return Loss | | | -15.7 | | -14.7 | | | dB |
| Carrier Feedthrough | | | -45.1 | | -39.9 | | | dBm |
| Sideband Suppression | | | -52.8 | | -49.9 | | | dBc |
| Quadrature Error | | | 0.01 | | 0.20 | | | Degrees |
| I/Q Amplitude Balance | | | 0.07 | | 0.10 | | | dB |
| Second Harmonic | $P_{OUT} - (f_{LO} + (2 \times f_{BB}))$ | | -75.8 | | -77.2 | | | dBc |
| ADL5375-05 | $P_{OUT} = 0.75\text{ dBm}$ | | | | | | | |
| ADL5375-15 | $P_{OUT} = 0.41\text{ dBm}$ | | | | | | | |
| Third Harmonic | $P_{OUT} - (f_{LO} + (3 \times f_{BB}))$ | | -50.7 | | -72.7 | | | dBc |
| ADL5375-05 | $P_{OUT} = 0.75\text{ dBm}$ | | | | | | | |
| ADL5375-15 | $P_{OUT} = 0.41\text{ dBm}$ | | | | | | | |
| Output IP2 | $f_{1BB} = 3.5\text{ MHz}$, $f_{2BB} = 4.5\text{ MHz}$, baseband I/Q amplitude per tone = 0.5 V p-p differential | | 62.6 | | 64.5 | | | dBm |
| Output IP3 | $f_{1BB} = 3.5\text{ MHz}$, $f_{2BB} = 4.5\text{ MHz}$, baseband I/Q amplitude per tone = 0.5 V p-p differential | | 25.9 | | 23.4 | | | dBm |
| Noise Floor | I/Q inputs = 0 V differential with a dc bias only, 20 MHz carrier offset | | -160.0 | | -157.1 | | | dBm/Hz |

| Parameter | Conditions | ADL5375-05 | | | ADL5375-15 | | | Unit |
|--------------------------------|--|------------|--------|-----|------------|-----|-----|---------|
| | | Min | Typ | Max | Min | Typ | Max | |
| LO = 1900 MHz | | | | | | | | |
| Output Power, P _{OUT} | V _{IQ} = 1 V p-p differential | | 0.53 | | 0.49 | | | dBm |
| Modulator Voltage Gain | RF output divided by baseband input voltage | | -3.4 | | -3.4 | | | dB |
| Output P1dB | | | 9.9 | | 10.5 | | | dBm |
| Output Return Loss | | | -16.2 | | -15.5 | | | dB |
| Carrier Feedthrough | | | -40.3 | | -35.5 | | | dBm |
| Sideband Suppression | | | -50.2 | | -49.4 | | | dBc |
| Quadrature Error | | | 0.02 | | 0.21 | | | Degrees |
| I/Q Amplitude Balance | | | 0.07 | | 0.10 | | | dB |
| Second Harmonic | P _{OUT} - (f _{LO} + (2 × f _{BB})) | | -67.9 | | -72.1 | | | dBc |
| ADL5375-05 | P _{OUT} = 0.53dBm | | | | | | | |
| ADL5375-15 | P _{OUT} = 0.49dBm | | | | | | | |
| Third Harmonic | P _{OUT} - (f _{LO} + (3 × f _{BB})) | | -51.8 | | -62.8 | | | dBc |
| ADL5375-05 | P _{OUT} = 0.53dBm | | | | | | | |
| ADL5375-15 | P _{OUT} = 0.49dBm | | | | | | | |
| Output IP2 | f1BB = 3.5 MHz, f2BB = 4.5 MHz, baseband I/Q amplitude per tone = 0.5 V p-p differential | | 62.6 | | 61 | | | dBm |
| Output IP3 | f1BB = 3.5 MHz, f2BB = 4.5 MHz, baseband I/Q amplitude per tone = 0.5 V p-p differential | | 24.3 | | 22.1 | | | dBm |
| Noise Floor | I/Q inputs = 0 V differential with a dc bias only, 20 MHz carrier offset | | -160.0 | | -158.2 | | | dBm/Hz |
| LO = 2150 MHz | | | | | | | | |
| Output Power, P _{OUT} | V _{IQ} = 1 V p-p differential | | 0.73 | | 0.57 | | | dBm |
| Modulator Voltage Gain | RF output divided by baseband input voltage | | -3.2 | | -3.4 | | | dB |
| Output P1dB | | | 10.0 | | 10.6 | | | dBm |
| Output Return Loss | | | -17.1 | | -16.1 | | | dB |
| Carrier Feedthrough | | | -39.7 | | -34.2 | | | dBm |
| Sideband Suppression | | | -47.3 | | -50.2 | | | dBc |
| Quadrature Error | | | -0.16 | | -0.18 | | | Degrees |
| I/Q Amplitude Balance | | | 0.07 | | 0.10 | | | dB |
| Second Harmonic | P _{OUT} - (f _{LO} + (2 × f _{BB})) | | -71.3 | | -81.7 | | | dBc |
| ADL5375-05 | P _{OUT} = 0.73 dBm | | | | | | | |
| ADL5375-15 | P _{OUT} = 0.57 dBm | | | | | | | |
| Third Harmonic | P _{OUT} - (f _{LO} + (3 × f _{BB})) | | -52.4 | | -65.3 | | | dBc |
| ADL5375-05 | P _{OUT} = 0.73 dBm | | | | | | | |
| ADL5375-15 | P _{OUT} = 0.57 dBm | | | | | | | |
| Output IP2 | f1BB = 3.5 MHz, f2BB = 4.5 MHz, baseband I/Q amplitude per tone = 0.5 V p-p differential | | 61.6 | | 61.8 | | | dBm |
| Output IP3 | f1BB = 3.5 MHz, f2BB = 4.5 MHz, baseband I/Q amplitude per tone = 0.5 V p-p differential | | 24.2 | | 22.3 | | | dBm |
| Noise Floor | I/Q inputs = 0 V differential with a dc bias only, 20 MHz carrier offset | | -159.5 | | -157.9 | | | dBm/Hz |
| LO = 2600 MHz | | | | | | | | |
| Output Power, P _{OUT} | V _{IQ} = 1 V p-p differential | | 0.61 | | 0.62 | | | dBm |
| Modulator Voltage Gain | RF output divided by baseband input voltage | | -3.4 | | -3.3 | | | dB |
| Output P1dB | | | 9.6 | | 10.6 | | | dBm |
| Output Return Loss | | | -19.3 | | -18 | | | dB |
| Carrier Feedthrough | | | -36.5 | | -33.3 | | | dBm |
| Sideband Suppression | | | -48.3 | | -48.5 | | | dBc |
| Quadrature Error | | | -0.37 | | 0.19 | | | Degrees |
| I/Q Amplitude Balance | | | 0.07 | | 0.11 | | | dB |
| Second Harmonic | P _{OUT} - (f _{LO} + (2 × f _{BB})) | | -60.9 | | -55.9 | | | dBc |

| Parameter | Conditions | ADL5375-05 | | | ADL5375-15 | | | Unit |
|--|--|------------|--------|-----|------------|--------|-----|---------|
| | | Min | Typ | Max | Min | Typ | Max | |
| ADL5375-05 ADL5375-15 Third Harmonic | $P_{OUT} = 0.61$ dBm $P_{OUT} = 0.62$ dBm $P_{OUT} - (f_{LO} + (3 \times f_{BB}))$ | | -51.3 | | | -57.6 | | dBc |
| ADL5375-05 ADL5375-15 Output IP2 | $P_{OUT} = 0.61$ dBm $P_{OUT} = 0.62$ dBm f1BB = 3.5 MHz, f2BB = 4.5 MHz, baseband I/Q amplitude per tone = 0.5 V p-p differential | | 55.0 | | | 50.1 | | dBm |
| Output IP3 | f1BB = 3.5 MHz, f2BB = 4.5 MHz, baseband I/Q amplitude per tone = 0.5 V p-p differential | | 22.7 | | | 20.7 | | dBm |
| Noise Floor | I/Q inputs = 0 V differential with a dc bias only, 20 MHz carrier offset | | -159.0 | | | -157.6 | | dBm/Hz |
| LO = 3500 MHz | | | | | | | | |
| Output Power, P_{OUT} | $V_{IQ} = 1$ V p-p differential | | 0.21 | | | 0.87 | | dBm |
| Modulator Voltage Gain | RF output divided by baseband input voltage | | -3.8 | | | -3.1 | | dB |
| Output P1dB | | | 9.6 | | | 10.2 | | dBm |
| Output Return Loss | | | -20.7 | | | -19.4 | | dB |
| Carrier Feedthrough | | | -30.4 | | | -28.6 | | dBm |
| Sideband Suppression | | | -48.3 | | | -48.8 | | dBc |
| Quadrature Error | | | 0.01 | | | 0.13 | | Degrees |
| I/Q Amplitude Balance | | | 0.08 | | | 0.11 | | dB |
| Second Harmonic | $P_{OUT} - (f_{LO} + (2 \times f_{BB}))$ | | -55.8 | | | -63 | | dBc |
| ADL5375-05 ADL5375-15 | $P_{OUT} = 0.21$ dBm $P_{OUT} = 0.87$ dBm | | | | | | | |
| Third Harmonic | $P_{OUT} - (f_{LO} + (3 \times f_{BB}))$ | | -50.2 | | | -56.2 | | dBc |
| ADL5375-05 ADL5375-15 | $P_{OUT} = 0.21$ dBm $P_{OUT} = 0.87$ dBm | | | | | | | |
| Output IP2 | f1BB = 3.5 MHz, f2BB = 4.5 MHz, baseband I/Q amplitude per tone = 0.5 V p-p differential | | 51.1 | | | 57.9 | | dBm |
| Output IP3 | f1BB = 3.5 MHz, f2BB = 4.5 MHz, baseband I/Q amplitude per tone = 0.5 V p-p differential | | 23.1 | | | 20.2 | | dBm |
| Noise Floor | I/Q inputs = 0 V differential with a dc bias only, 20 MHz carrier offset | | -157.6 | | | -156.3 | | dBm/Hz |
| LO = 5800 MHz | | | | | | | | |
| Output Power, P_{OUT} | $V_{IQ} = 1$ V p-p differential | | -1.36 | | | 0.16 | | dBm |
| Modulator Voltage Gain | RF output divided by baseband input voltage | | -5.3 | | | -3.8 | | dB |
| Output P1dB | | | 4.9 | | | 4.4 | | dBm |
| Output Return Loss | | | -7.4 | | | -8.6 | | dB |
| Carrier Feedthrough | | | -19.5 | | | -16.7 | | dBm |
| Sideband Suppression | | | -38.2 | | | -39 | | dBc |
| Quadrature Error | | | -0.51 | | | -0.50 | | Degrees |
| I/Q Amplitude Balance | | | -0.05 | | | -0.70 | | dB |
| Second Harmonic | $P_{OUT} - (f_{LO} + (2 \times f_{BB}))$ | | -52.6 | | | -50 | | dBc |
| ADL5375-05 ADL5375-15 | $P_{OUT} = -1.36$ dBm $P_{OUT} = 0.16$ dBm | | | | | | | |
| Third Harmonic | $P_{OUT} - (f_{LO} + (3 \times f_{BB}))$ | | -45.7 | | | -48.4 | | dBc |
| ADL5375-05 ADL5375-15 | $P_{OUT} = -1.36$ dBm $P_{OUT} = 0.16$ dBm | | | | | | | |
| Output IP2 | f1BB = 3.5 MHz, f2BB = 4.5 MHz, baseband I/Q amplitude per tone = 0.5 V p-p differential | | 39.1 | | | 38.7 | | dBm |
| Output IP3 | f1BB = 3.5 MHz, f2BB = 4.5 MHz, baseband I/Q amplitude per tone = 0.5 V p-p differential | | 14.6 | | | 11.2 | | dBm |
| Noise Floor | I/Q inputs = 0 V differential with a dc bias only, 20 MHz carrier offset | | -153.0 | | | -153.4 | | dBm/Hz |

| Parameter | Conditions | ADL5375-05 | | | ADL5375-15 | | | Unit | |
|-------------------------------------|---|---|-----|------------|------------|------|------------|------|------------|
| | | Min | Typ | Max | Min | Typ | Max | | |
| LO INPUTS | | | | | | | | | |
| LO Drive Level | Characterization performed at typical level 500 MHz < f_{LO} < 3.3 GHz See Figure 7 and Figure 32 for return loss vs. frequency | -6 | 0 | +6 | -6 | 0 | +6 | dBm | |
| Input Return Loss | | | | ≤ -10 | | | ≤ -10 | dB | |
| BASEBAND INPUTS | Pin IBBP, Pin IBBN, Pin QBBP, Pin QBBN | | | | | | | | |
| I/Q Input Bias Level ¹ | On Pin IBBP, Pin IBBN, Pin QBBP, Pin QBBN Current sourcing from each baseband input | 0 | 500 | 1 | 1 | 1500 | 2 | mV | |
| Absolute Voltage Level ¹ | | | | | | | | | V |
| Input Bias Current | | | | 41 | | | 32 | | μ A |
| Input Offset Current | | | | 0.1 | | | 0.1 | | μ A |
| Differential Input Impedance | | | | 60 | | | 100 | | k Ω |
| Bandwidth (0.1 dB) | | LO = 1900 MHz, baseband input = 500 mV p-p sine wave | | 95 | | | 80 | | MHz |
| OUTPUT DISABLE | Pin DSOP | | | | | | | | |
| Off Isolation | P_{OUT} (DSOP low) – P_{OUT} (DSOP high) DSOP high, LO leakage, LO = 2150 MHz | | 84 | | | 85 | | dB | |
| Turn-On Settling Time | DSOP high to low (90% of envelope) | | -55 | | | -53 | | dBm | |
| Turn-Off Settling Time | DSOP low to high (10% of envelope) | | 220 | | | 220 | | ns | |
| DSOP High Level (Logic 1) | | 2.0 | 100 | | 2.0 | 100 | | ns | |
| DSOP Low Level (Logic 0) | | | | 0.8 | | | 0.8 | V | |
| POWER SUPPLIES | Pin VPS1 and Pin VPS2 | | | | | | | | |
| Voltage | | 4.75 | | 5.25 | 4.75 | | 5.25 | V | |
| Supply Current | DSOP = low | | 194 | | | 203 | | mA | |
| | DSOP = high | | 126 | | | 127 | | mA | |

¹ The input bias level can vary as long as the voltages on the individual IBBP, IBBN, QBBP, and QBBN pins remain within the specified absolute voltage level.

ABSOLUTE MAXIMUM RATINGS

Table 2.

| Parameter | Rating |
|---|-----------------|
| Supply Voltage, VPOS | 5.5 V |
| IBBP, IBBN, QBBP, QBBN | 0 V to 2 V |
| LOIP and LOIN | 13 dBm |
| Internal Power Dissipation | |
| ADL5375-05 | 1500 mW |
| ADL5375-15 | 1200 mW |
| θ_{JA} (Exposed Paddle Soldered Down) ¹ | 54°C/W |
| Maximum Junction Temperature | 150°C |
| Operating Temperature Range | -40°C to +85°C |
| Storage Temperature Range | -65°C to +150°C |

¹ Per JEDEC standard JESD 51-2. For information on optimizing thermal impedance, see the Thermal Grounding and Evaluation Board Layout section.

Stresses above those listed under Absolute Maximum Ratings may cause permanent damage to the device. This is a stress rating only; functional operation of the device at these or any other conditions above those indicated in the operational section of this specification is not implied. Exposure to absolute maximum rating conditions for extended periods may affect device reliability.

ESD CAUTION



ESD (electrostatic discharge) sensitive device. Charged devices and circuit boards can discharge without detection. Although this product features patented or proprietary protection circuitry, damage may occur on devices subjected to high energy ESD. Therefore, proper ESD precautions should be taken to avoid performance degradation or loss of functionality.

PIN CONFIGURATION AND FUNCTION DESCRIPTIONS

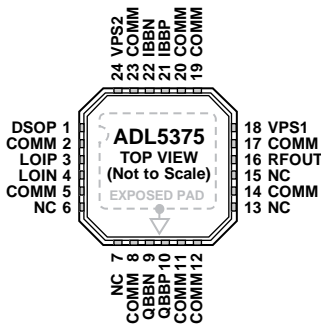

NOTES

1. NC = NO CONNECT. DO NOT CONNECT TO THIS PIN.
2. CONNECT EXPOSED PAD TO THE GROUND LANE VIA A LOW IMPEDANCE PATH.

07052-003

Figure 2. Pin Configuration

Table 3. Pin Function Descriptions

| Pin No. | Mnemonic | Description |
|--|---------------------------------|--|
| 1 | DSOP | Output Disable. A logic high on this pin disables the RF output. Connect this pin to ground or leave it floating to enable the output. |
| 2, 5, 8, 11, 12, 14, 17, 19, 20, 23 3, 4 | COMM LOIP, LOIN | Input Common Pins. Connect to the ground plane via a low impedance path. Local Oscillator Inputs. Single-ended operation: The LOIP pin is driven from the LO source through an ac-coupling capacitor while the LOIN pin is ac-coupled to ground through a capacitor. Differential operation: The LOIP and LOIN pins must be driven differentially through ac-coupling capacitors in this mode of operation. |
| 6, 7, 13, 15, 9, 10, 21, 22 | NC QBPN, QBPN, IBBP, IBPN | No Connect. These pins can be left open or tied to ground. Differential In-Phase and Quadrature Baseband Inputs. These high impedance inputs should be dc-biased to the recommended level depending on the version. ADL5375-05 : 500 mV ADL5375-15 : 1500 mV These inputs should be driven from a low impedance source. Nominal characterized ac signal swing is 500 mV p-p on each pin. This results in a differential drive of 1 V p-p. These inputs are not self-biased and have to be externally biased. |
| 16 | RFOUT | RF Output. Single-ended, 50 Ω internally biased RF output. RFOUT must be ac-coupled to the load. |
| 18, 24 | VPS1, VPS2 | Positive Supply Voltage Pins. All pins should be connected to the same supply (V_s). To ensure adequate external bypassing, connect 0.1 μ F and 100 pF capacitors between each pin and ground. |
| | EP | Exposed Paddle. Connect to the ground plane via a low impedance path. |

TYPICAL PERFORMANCE CHARACTERISTICS

ADL5375-05

$V_S = 5\text{ V}$; $T_A = 25^\circ\text{C}$; LO = 0 dBm single-ended drive; baseband I/Q amplitude = 1 V p-p differential sine waves in quadrature with a 500 mV dc bias; baseband I/Q frequency (f_{BB}) = 1 MHz, unless otherwise noted.

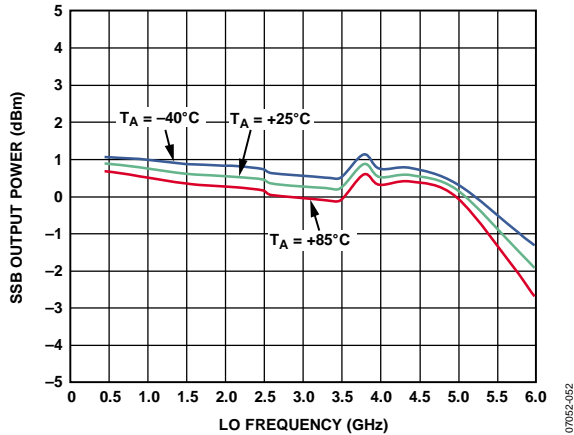

Figure 3. Single-Sideband (SSB) Output Power (P_{out}) vs. LO Frequency (f_{LO}) and Temperature

07052-052

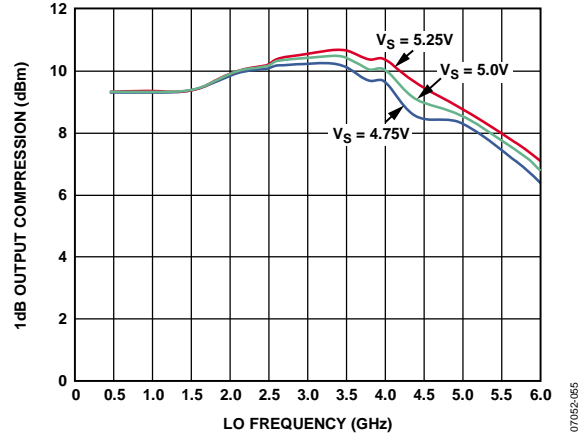

Figure 6. SSB Output 1dB Compression Point (OP_{1dB}) vs. LO Frequency (f_{LO}) and Supply

07052-055

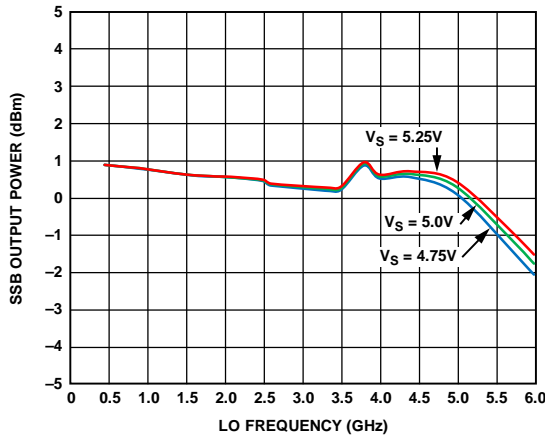

Figure 4. Single-Sideband (SSB) Output Power (P_{out}) vs. LO Frequency (f_{LO}) and Supply

07052-053

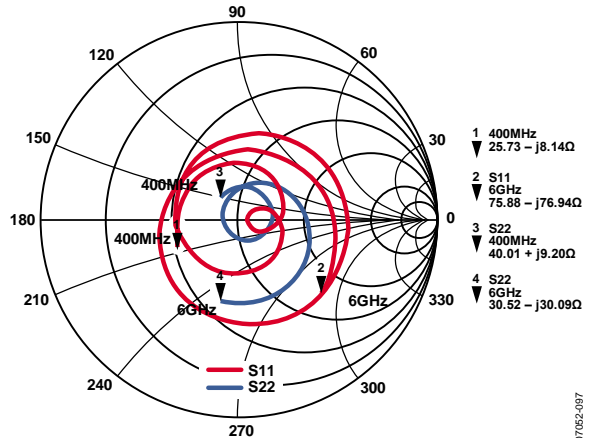

Figure 7. Smith Chart of LOIP (LOIN AC-Coupled to Ground) S_{11} and RFOUT S_{22} from 450 MHz to 6000 MHz

07052-097

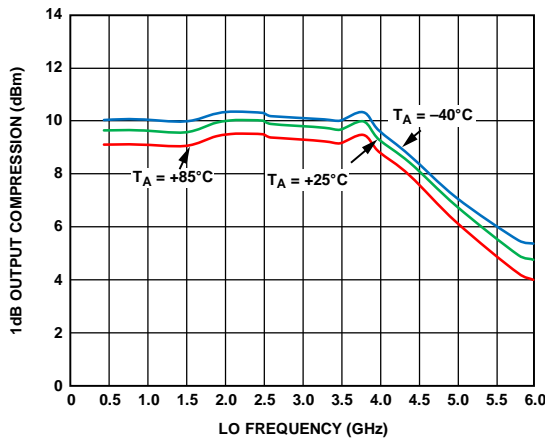

Figure 5. SSB Output 1dB Compression Point (OP_{1dB}) vs. LO Frequency (f_{LO}) and Temperature

07052-054

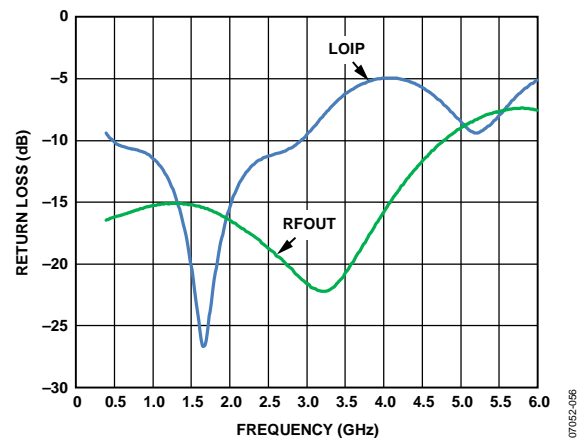

Figure 8. Return Loss of LOIP (LOIN AC-Coupled to Ground) S_{11} and RFOUT S_{22} from 450 MHz to 6000 MHz

07052-056

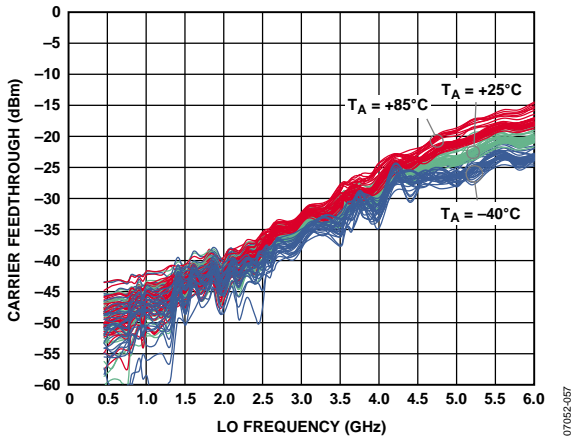

Figure 9. Carrier Feedthrough vs. LO Frequency (f_{LO}) and Temperature; Multiple Devices Shown

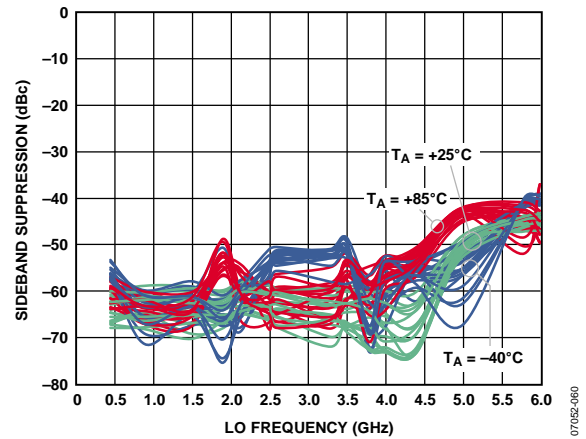

Figure 12. Sideband Suppression vs. LO Frequency (f_{LO}) and Temperature After Nulling at 25°C; Multiple Devices Shown

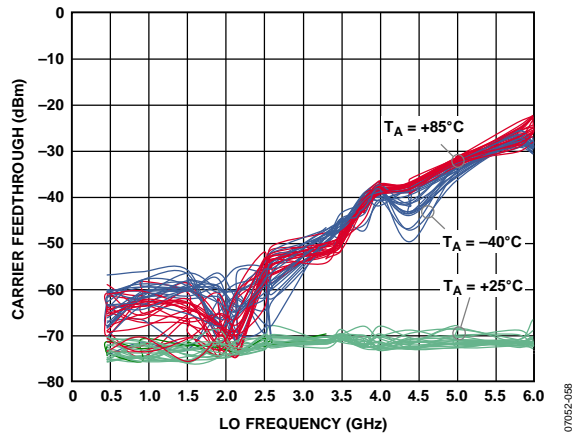

Figure 10. Carrier Feedthrough vs. LO Frequency (f_{LO}) and Temperature After Nulling at 25°C; Multiple Devices Shown

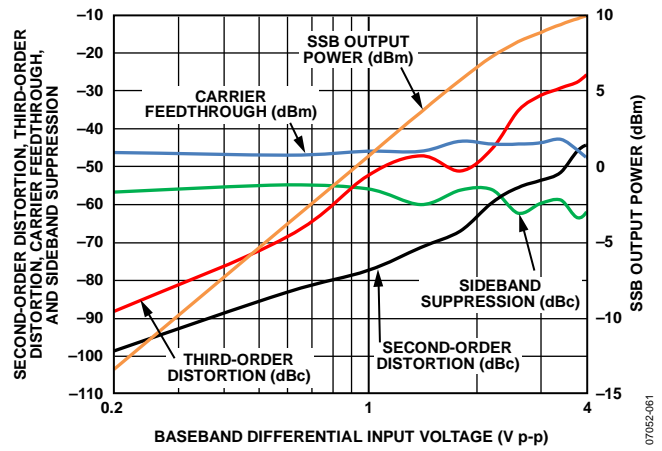

Figure 13. Second- and Third-Order Distortion, Carrier Feedthrough, Sideband Suppression, and SSB P_{OUT} vs. Baseband Differential Input Level ($f_{LO} = 900$ MHz)

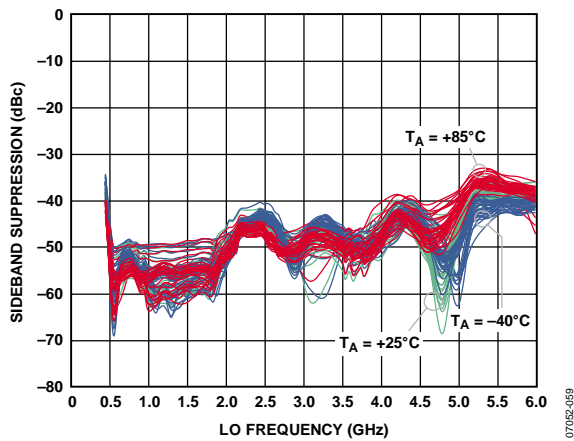

Figure 11. Sideband Suppression vs. LO Frequency (f_{LO}) and Temperature; Multiple Devices Shown

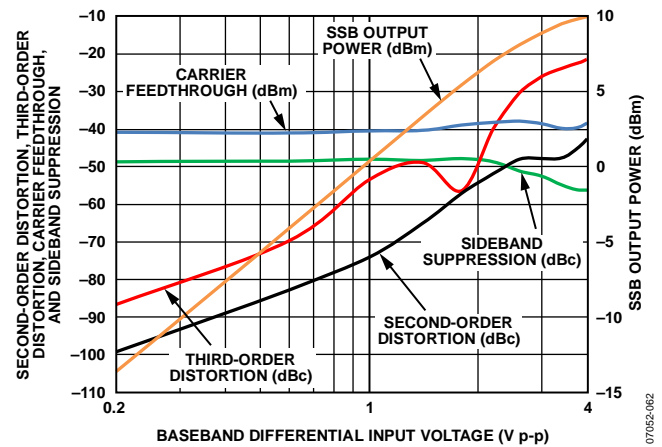

Figure 14. Second- and Third-Order Distortion, Carrier Feedthrough, Sideband Suppression, and SSB P_{OUT} vs. Baseband Differential Input Level ($f_{LO} = 2150$ MHz)

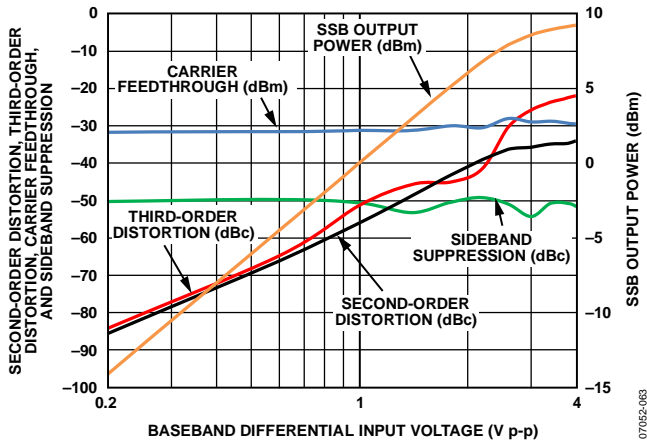

Figure 15. Second- and Third-Order Distortion, Carrier Feedthrough, Sideband Suppression, and SSB P_{OUT} vs. Baseband Differential Input Level ($f_{LO} = 3500$ MHz)

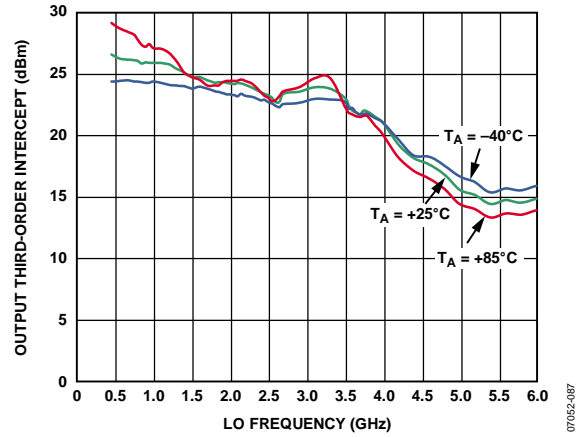

Figure 18. OIP3 vs. LO Frequency (f_{LO}) and Temperature ($P_{OUT} \approx -5$ dBm)

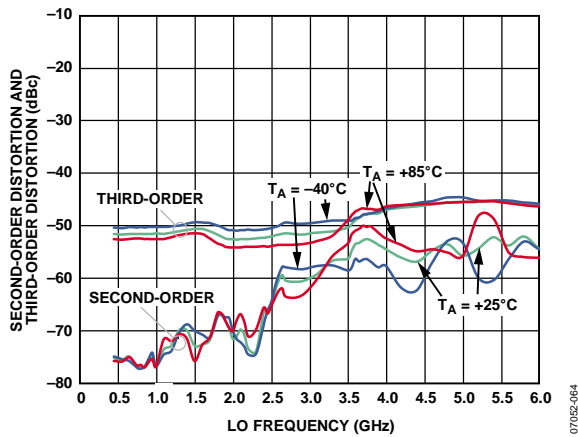

Figure 16. Second- and Third-Order Distortion vs. LO Frequency (f_{LO}) and Temperature (Baseband I/Q Amplitude = 1 V p-p Differential)

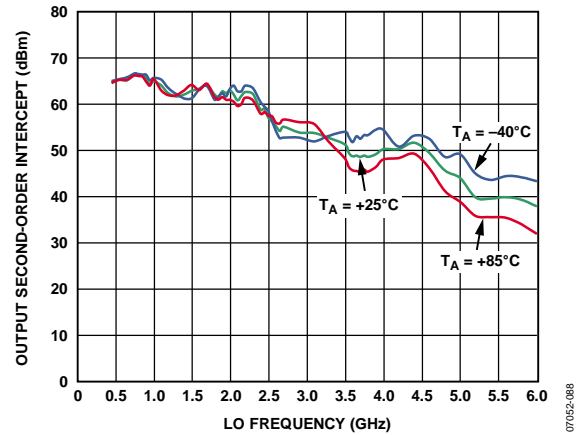

Figure 19. OIP2 vs. LO Frequency (f_{LO}) and Temperature ($P_{OUT} \approx -5$ dBm)

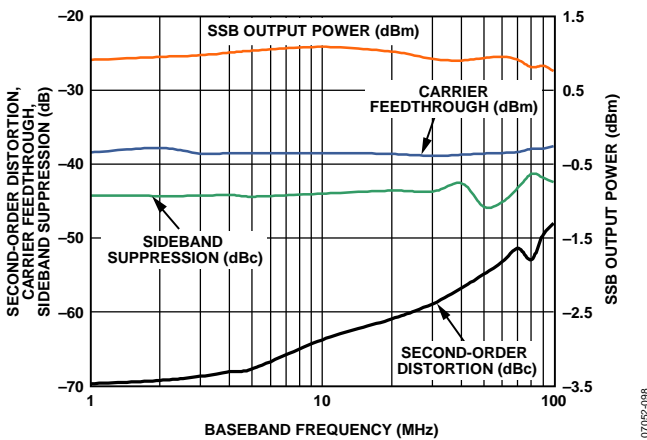

Figure 17. Second-Order Distortion, Carrier Feedthrough, Sideband Suppression, and SSB P_{OUT} vs. Baseband Frequency (f_{BB} ; $f_{LO} = 2140$ MHz)

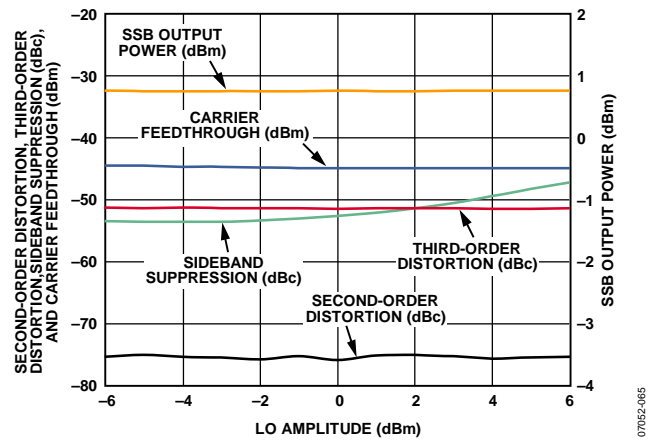

Figure 20. Second- and Third-Order Distortion, Carrier Feedthrough, Sideband Suppression, and SSB P_{OUT} vs. LO Amplitude ($f_{LO} = 900$ MHz)

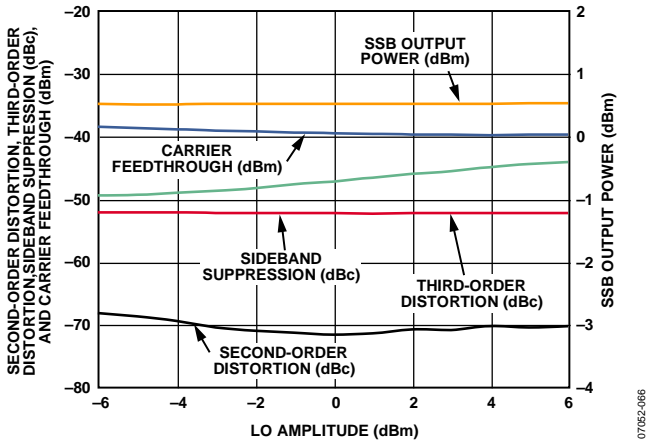

Figure 21. Second- and Third-Order Distortion, Carrier Feedthrough, Sideband Suppression, and SSB P_{OUT} vs. LO Amplitude ($f_{LO} = 2150$ MHz)

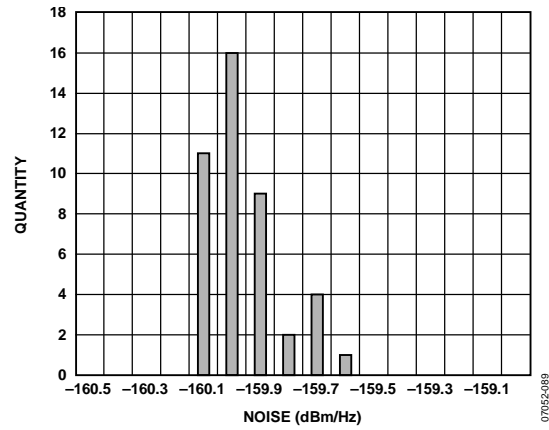

Figure 24. 20 MHz Offset Noise Floor Distribution at $f_{LO} = 900$ MHz (I/Q Amplitude = 0 mV p-p with 500 mV DC Bias)

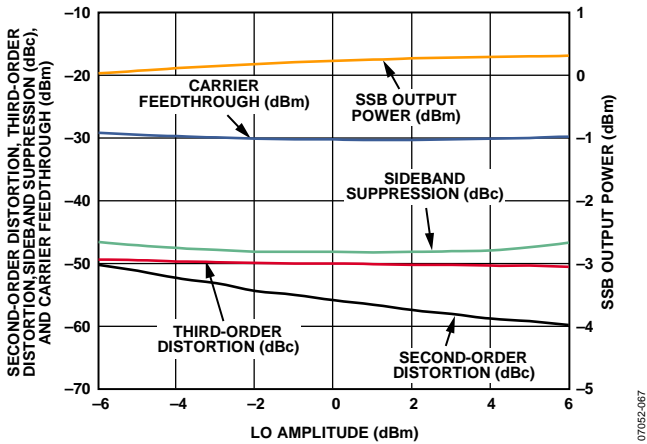

Figure 22. Second- and Third-Order Distortion, Carrier Feedthrough, Sideband Suppression, and SSB P_{OUT} vs. LO Amplitude ($f_{LO} = 3500$ MHz)

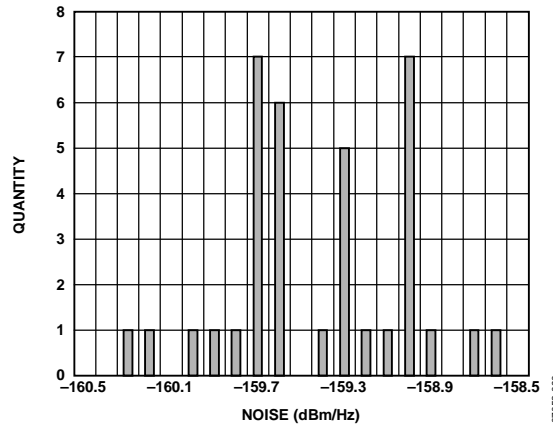

Figure 25. 20 MHz Offset Noise Floor Distribution at $f_{LO} = 2140$ MHz (I/Q Amplitude = 0 mV p-p with 500 mV DC Bias)

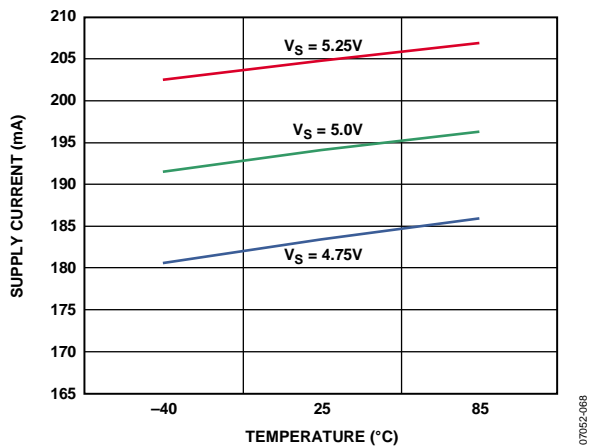

Figure 23. Power Supply Current vs. Temperature

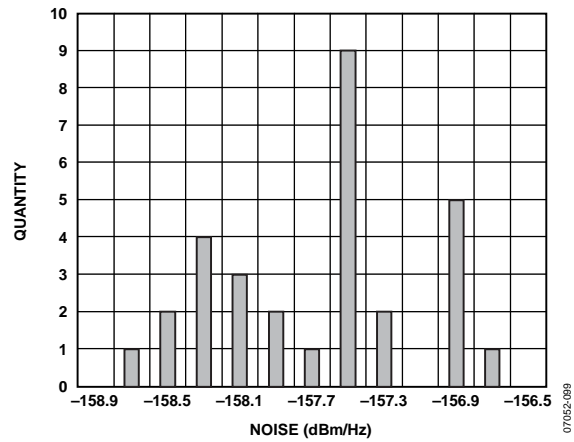

Figure 26. 20 MHz Offset Noise Floor Distribution at $f_{LO} = 3500$ MHz (I/Q Amplitude = 0 mV p-p with 500 mV DC Bias)

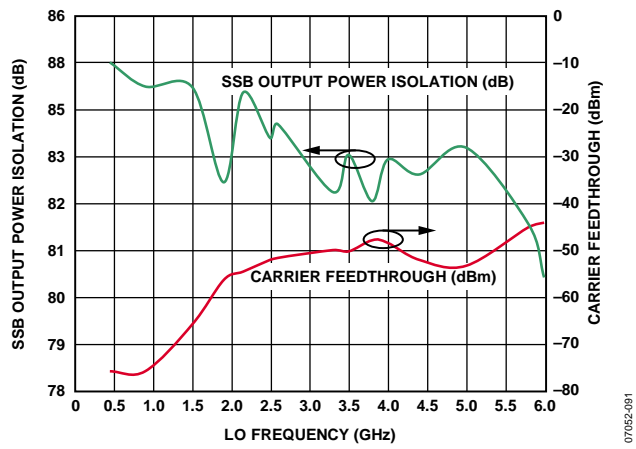

Figure 27. SSB P_{OUT} Isolation and Carrier Feedthrough with DSOP High

ADL5375-15

$V_S = 5\text{ V}$; $T_A = 25^\circ\text{C}$; LO = 0 dBm single-ended drive; baseband I/Q amplitude = 1 V p-p differential sine waves in quadrature with a 1500 mV dc bias; baseband I/Q frequency (f_{BB}) = 1 MHz, unless otherwise noted.

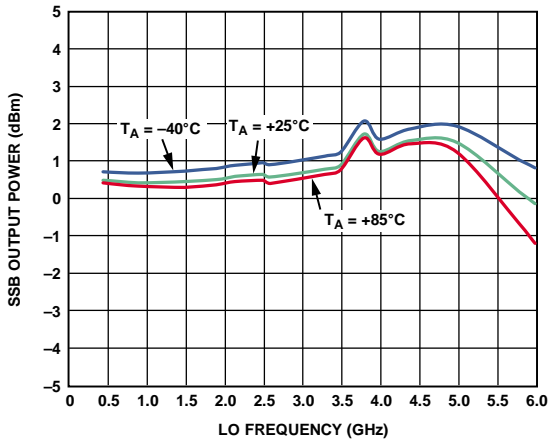

Figure 28. Single-Sideband (SSB) Output Power (P_{out}) vs. LO Frequency (f_{LO}) and Temperature

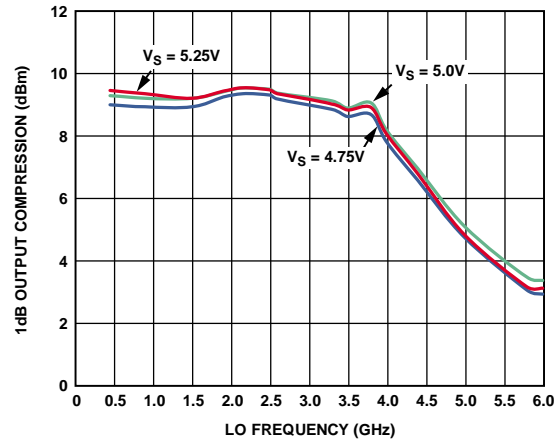

Figure 31. SSB Output 1dB Compression Point (OP_{1dB}) vs. LO Frequency (f_{LO}) and Supply

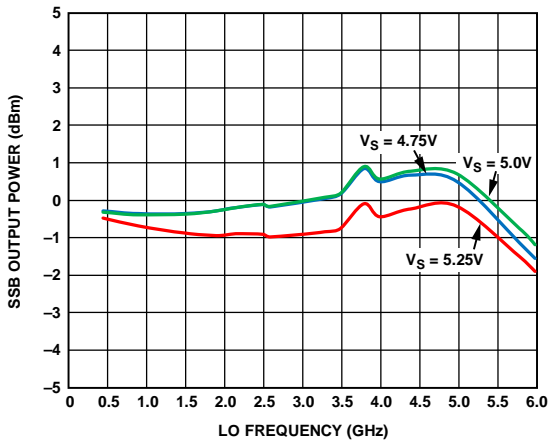

Figure 29. Single-Sideband (SSB) Output Power (P_{out}) vs. LO Frequency (f_{LO}) and Supply

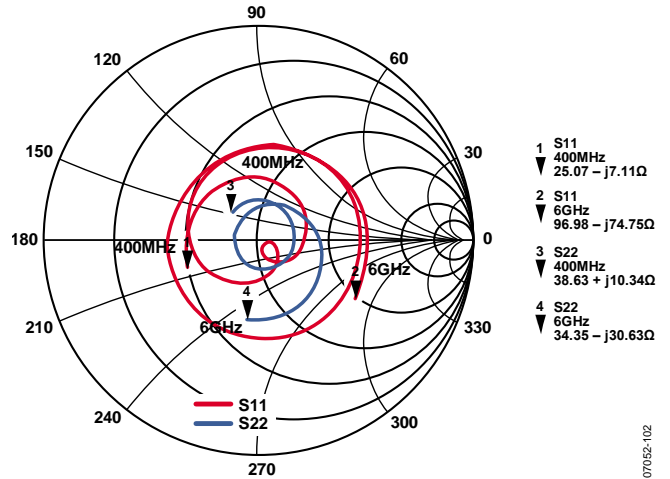

Figure 32. Smith Chart of LOIP (LOIN AC-Coupled to Ground) S11 and RFOUT S22 from 450 MHz to 6000 MHz

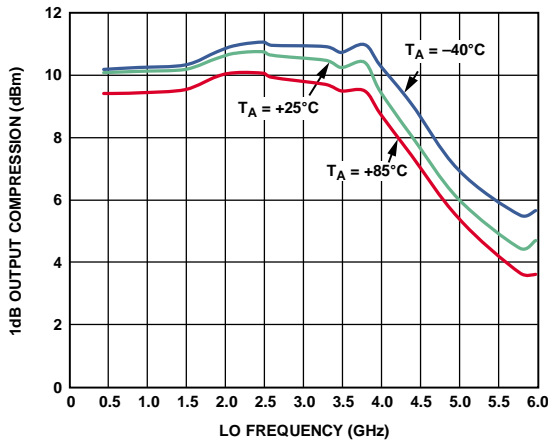

Figure 30. SSB Output 1dB Compression Point (OP_{1dB}) vs. LO Frequency (f_{LO}) and Temperature

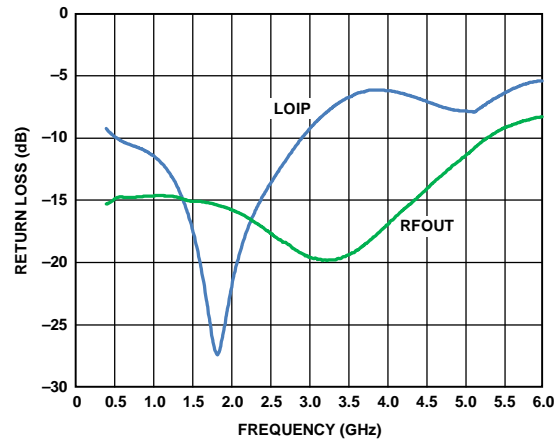

Figure 33. Return Loss of LOIP (LOIN AC-Coupled to Ground) S11 and RFOUT S22 from 450 MHz to 6000 MHz

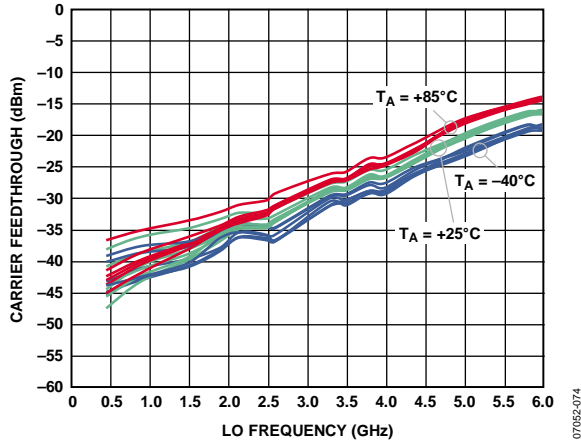

Figure 34. Carrier Feedthrough vs. LO Frequency (f_{LO}) and Temperature; Multiple Devices Shown

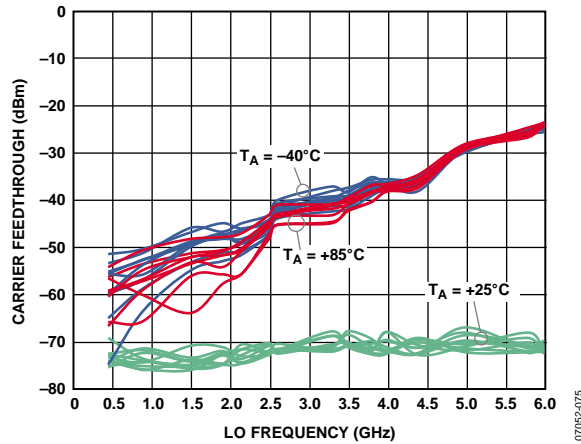

Figure 35. Carrier Feedthrough vs. LO Frequency (f_{LO}) and Temperature After Nulling at 25°C; Multiple Devices Shown

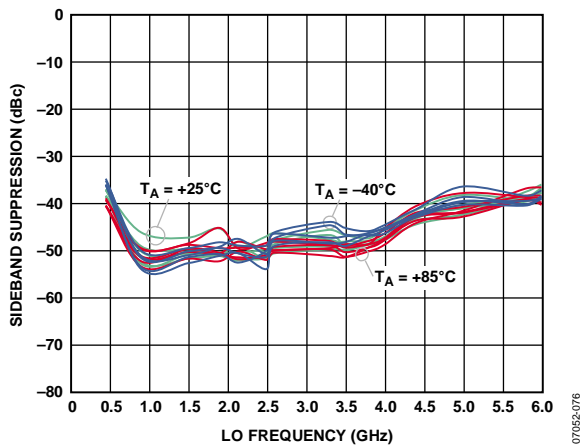

Figure 36. Sideband Suppression vs. LO Frequency (f_{LO}) and Temperature; Multiple Devices Shown

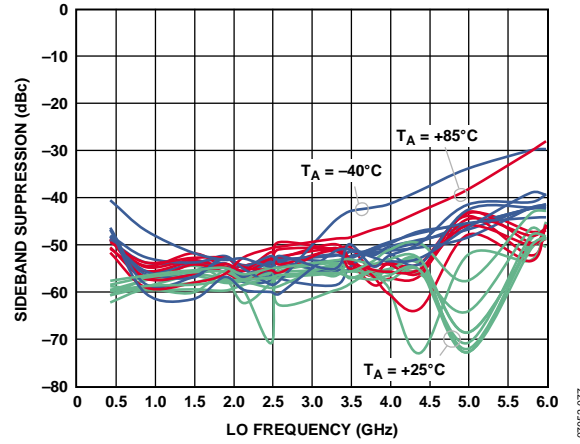

Figure 37. Sideband Suppression vs. LO Frequency (f_{LO}) and Temperature After Nulling at 25°C; Multiple Devices Shown

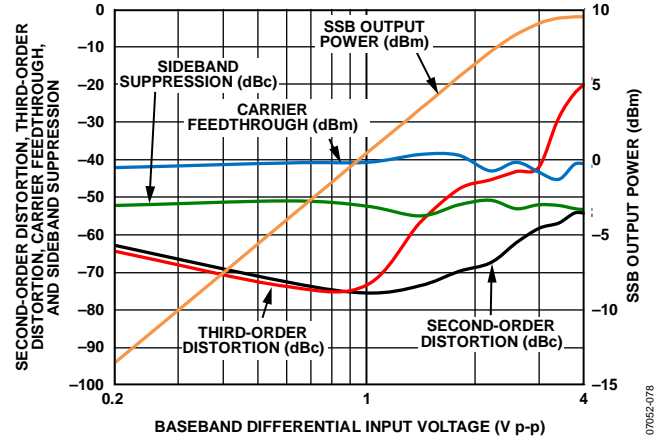

Figure 38. Second- and Third-Order Distortion, Carrier Feedthrough, Sideband Suppression, and SSB P_{OUT} vs. Baseband Differential Input Level ($f_{LO} = 900$ MHz)

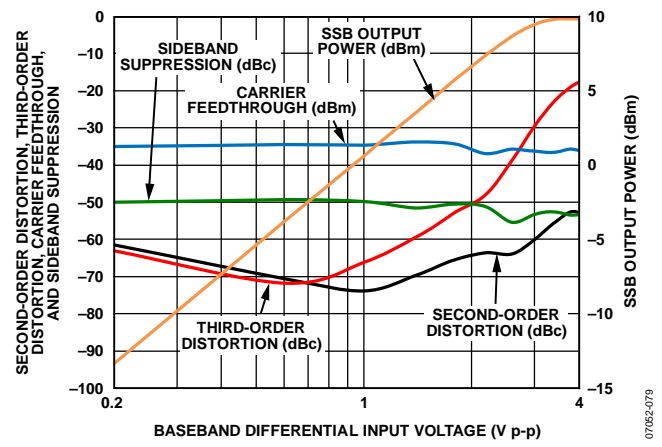

Figure 39. Second- and Third-Order Distortion, Carrier Feedthrough, Sideband Suppression, and SSB P_{OUT} vs. Baseband Differential Input Level ($f_{LO} = 2150$ MHz)

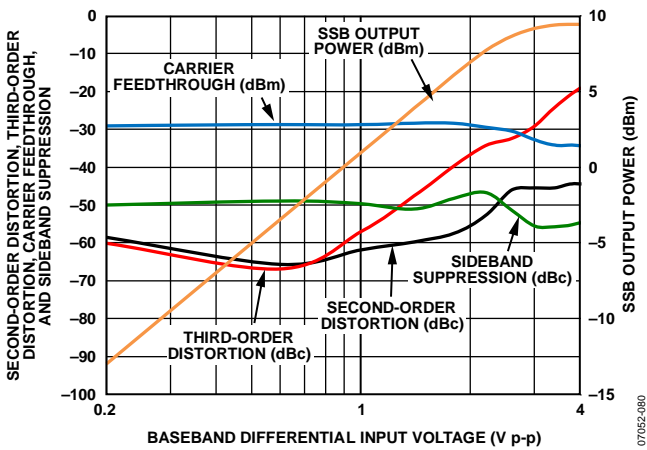

Figure 40. Second- and Third-Order Distortion, Carrier Feedthrough, Sideband Suppression, and SSB P_{OUT} vs. Baseband Differential Input Level ($f_{LO} = 3500$ MHz)

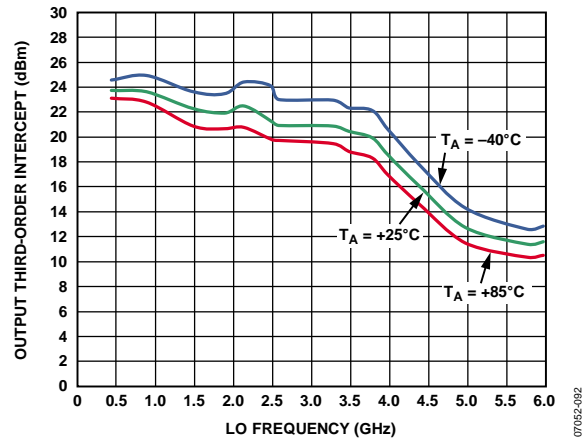

Figure 43. OIP3 vs. LO Frequency (f_{LO}) and Temperature ($P_{OUT} \approx -5$ dBm at $f_{LO} = 900$ MHz)

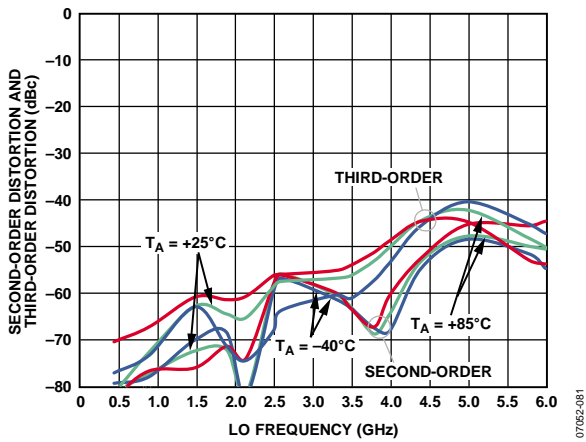

Figure 41. Second- and Third-Order Distortion vs. LO Frequency (f_{LO}) and Temperature (Baseband I/Q Amplitude = 1 V p-p Differential)

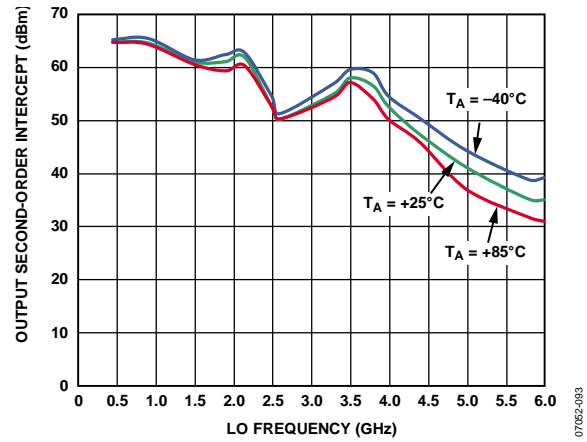

Figure 44. OIP2 vs. LO Frequency (f_{LO}) and Temperature ($P_{OUT} \approx -5$ dBm at $f_{LO} = 900$ MHz)

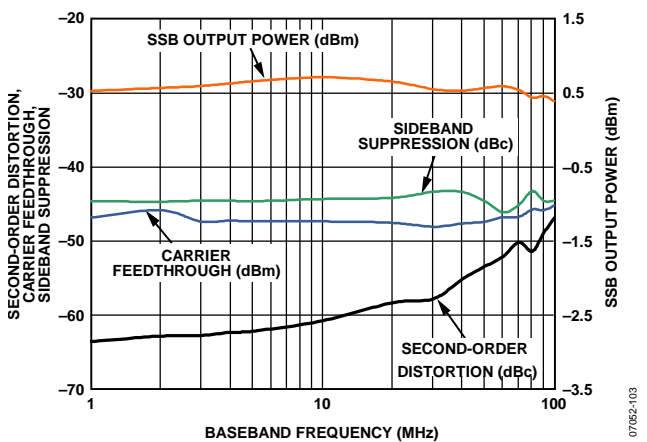

Figure 42. Second-Order Distortion, Carrier Feedthrough, Sideband Suppression, and SSB P_{OUT} vs. Baseband Frequency (f_{BB}); $f_{LO} = 2140$ MHz

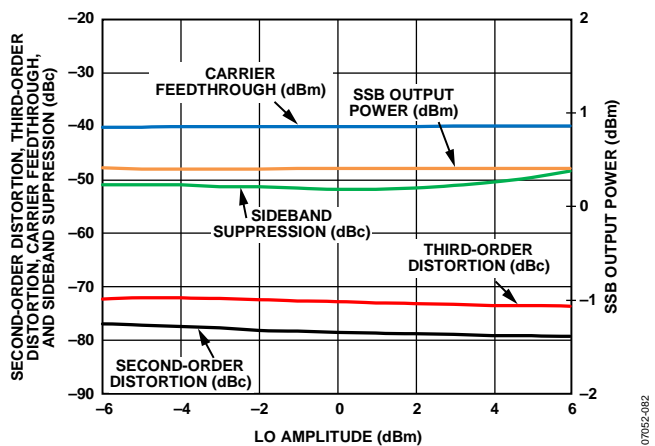

Figure 45. Second- and Third-Order Distortion, Carrier Feedthrough, Sideband Suppression, and SSB P_{OUT} vs. LO Amplitude ($f_{LO} = 900$ MHz)

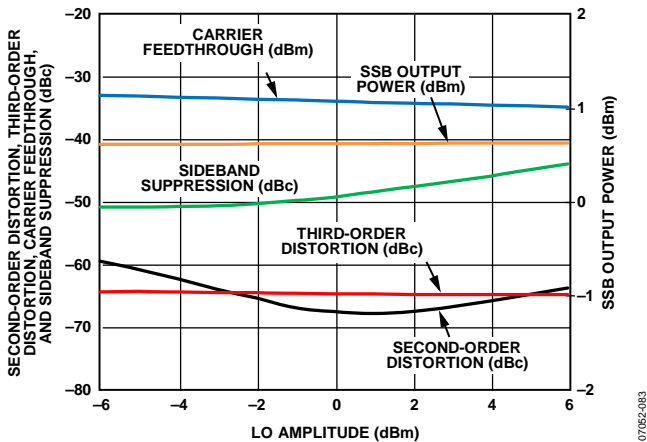

Figure 46. Second- and Third-Order Distortion, Carrier Feedthrough, Sideband Suppression, and SSB P_{OUT} vs. LO Amplitude ($f_{LO} = 2150$ MHz)

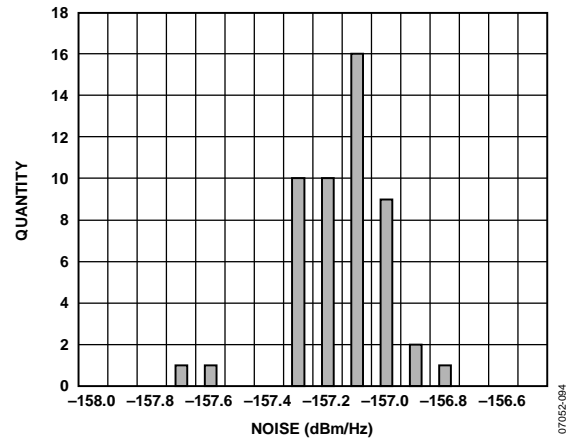

Figure 49. 20 MHz Offset Noise Floor Distribution at $f_{LO} = 900$ MHz (I/Q Amplitude = 0 mV p-p with 1500 mV DC Bias)

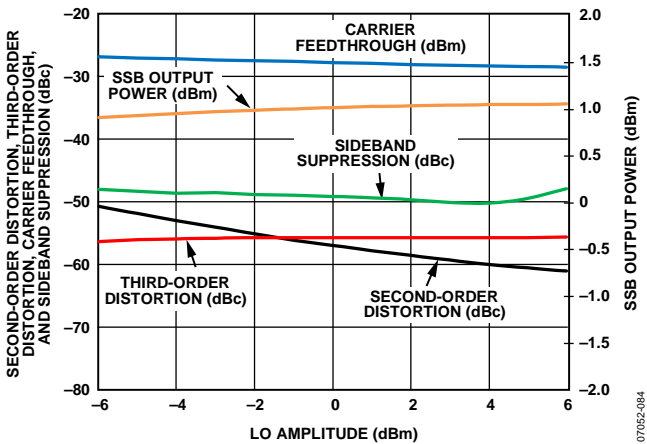

Figure 47. Second- and Third-Order Distortion, Carrier Feedthrough, Sideband Suppression, and SSB P_{OUT} vs. LO Amplitude ($f_{LO} = 3500$ MHz)

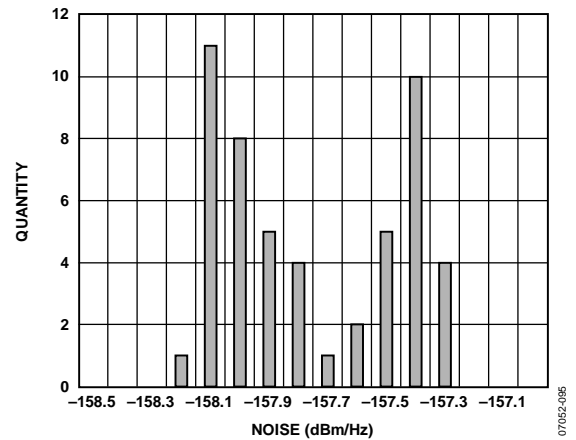

Figure 50. 20 MHz Offset Noise Floor Distribution at $f_{LO} = 2140$ MHz (I/Q Amplitude = 0 mV p-p with 1500 mV DC Bias)

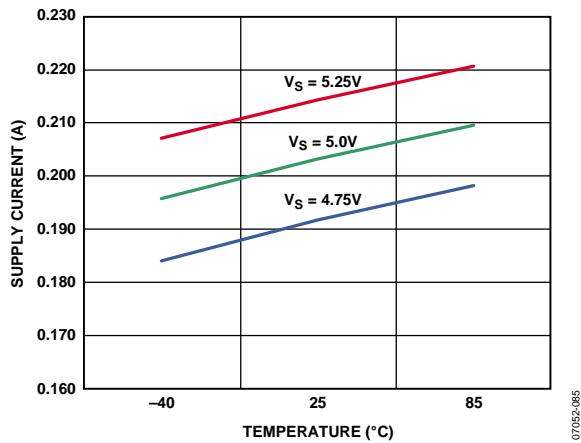

Figure 48. Power Supply Current vs. Temperature

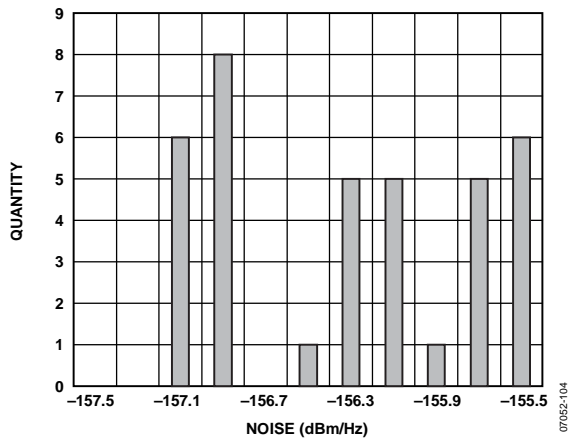

Figure 51. 20 MHz Offset Noise Floor Distribution at $f_{LO} = 3500$ MHz (I/Q Amplitude = 0 mV p-p with 500 mV DC Bias)

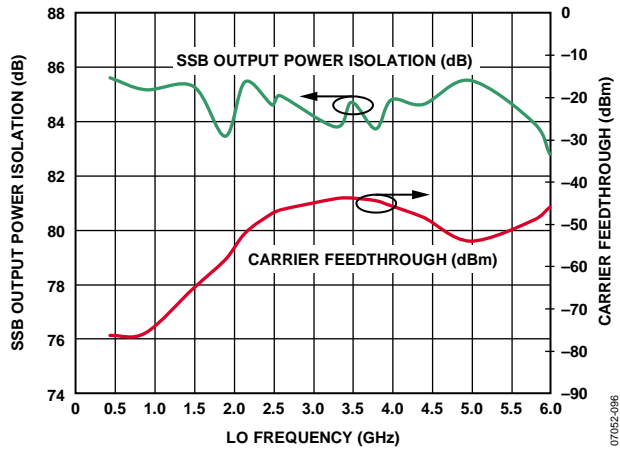

Figure 52. SSB P_{OUT} Isolation and Carrier Feedthrough with DSOP High

THEORY OF OPERATION

CIRCUIT DESCRIPTION

The ADL5375 can be divided into five circuit blocks: the LO interface, the baseband voltage-to-current (V-to-I) converter, the mixers, the differential-to-single-ended (D-to-S) stage, and the bias circuit. A block diagram of the device is shown in Figure 53.

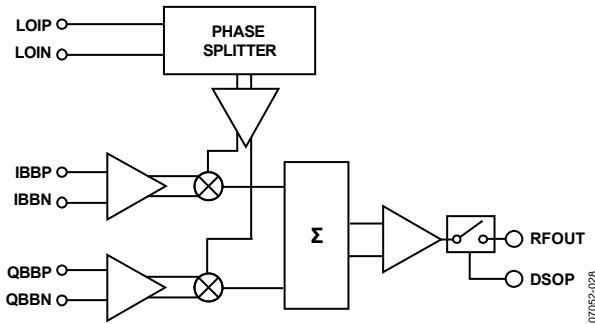

Figure 53. Block Diagram

The LO interface generates two LO signals in quadrature. These signals are used to drive the mixers. The I/Q baseband input signals are converted to currents by the V-to-I stages, which then drive the two mixers. The outputs of these mixers combine to feed the output balun, which provides a single-ended output. The bias cell generates reference currents for the V-to-I stage.

LO Interface

The LO interface consists of a polyphase quadrature splitter and a limiting amplifier. The LO input impedance is set by the polyphase splitter. Each quadrature LO signal then passes through a limiting amplifier that provides the mixer with a limited drive signal.

The LO input can be driven single-ended or differentially. For applications above 3 GHz, improved OIP2 and LO leakage may result from driving the LO input differentially.

V-to-I Converter

The differential baseband inputs (QBBP, QBPN, IBBN, and IBBP) present a high impedance. The voltages applied to these pins drive the V-to-I stage that converts baseband voltages into currents. The differential output currents of the V-to-I stages feed each of their respective mixers. The dc common-mode voltage at the baseband inputs sets the currents in the two mixer cores. Varying the baseband common-mode voltage influences the current in the mixer and affects overall modulation performance. The recommended dc voltage for the baseband common-mode voltage is 500 mV dc for the ADL5375-05 and 1500 mV for the ADL5375-15.

Mixers

The ADL5375 has two double-balanced mixers: one for the in-phase channel (I channel) and one for the quadrature channel (Q-channel). The output currents from the two mixers sum together into an internal load. The signal developed across this load is used to drive the D-to-S stage.

D-to-S Stage

The output D-to-S stage consists of an on-chip active balun that converts the differential signal to a single-ended signal. The balun presents 50 Ω impedance to the output (VOUT). Therefore, no matching network is needed at the RF output for optimal power transfer in a 50 Ω environment.

Bias Circuit

An on-chip band gap reference circuit is used to generate a proportional-to-absolute temperature (PTAT) reference current for the V-to-I stage.

DSOP

The DSOP pin can be used to disable the output stage of the modulator. If the DSOP pin is connected to ground or left unconnected, the part operates normally. If the DSOP pin is connected to the positive voltage supply, the output stage is disabled and the LO leakage is also reduced.

BASIC CONNECTIONS

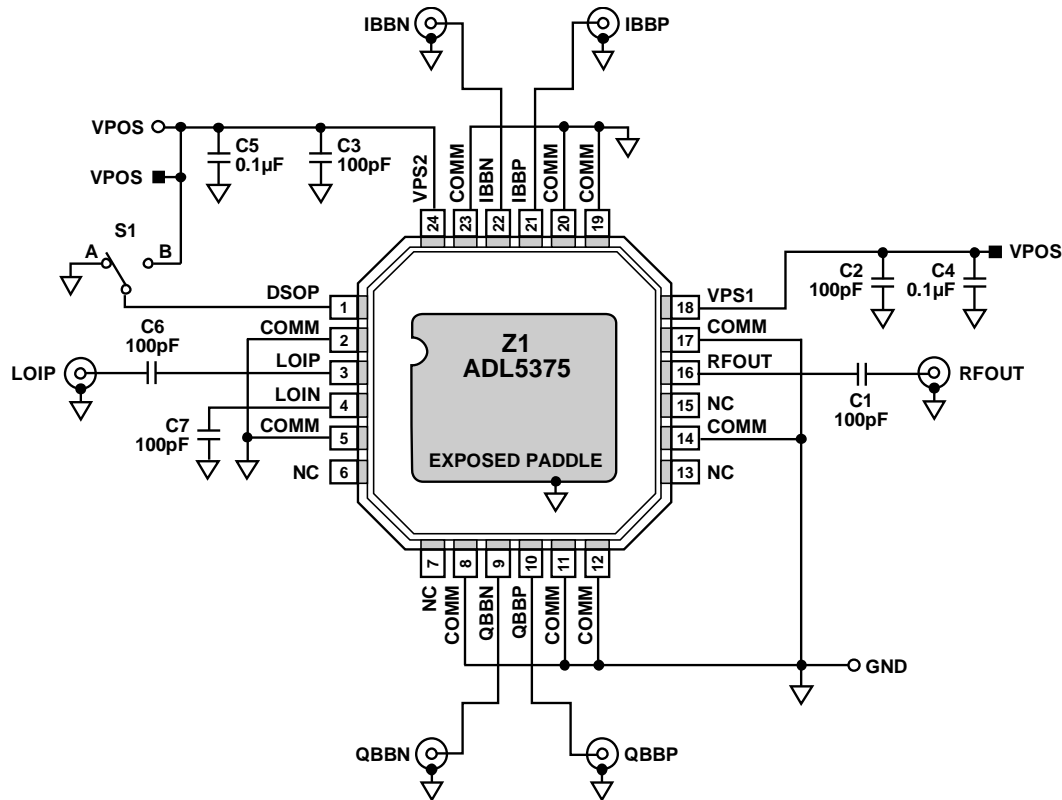

Figure 54. Basic Connections for the [ADL5375](#)

Figure 54 shows the basic connections for the [ADL5375](#).

POWER SUPPLY AND GROUNDING

Pin VPS1 and Pin VPS2 should be connected to the same 5 V source. Each pin should be decoupled with a 100 pF and 0.1 μ F capacitor. These capacitors should be located as close as possible to the device. The power supply can range between 4.75 V and 5.25 V.

The ten COMM pins should be tied to the same ground plane through low impedance paths.

The exposed paddle on the underside of the package should also be soldered to a ground plane with low thermal and electrical impedance. If the ground plane spans multiple layers on the circuit board, they should be stitched together with nine vias under the exposed paddle as illustrated in the Evaluation Board section. The [AN-772](#) Application Note discusses the thermal and electrical grounding of the LFCSP (QFN) package in detail.

BASEBAND INPUTS

The baseband inputs (IBBP, IBBN, QBBP, and QBBN) should be driven from a differential source. The nominal drive level used in the characterization of the [ADL5375](#) is 1 V p-p differential (or 500 mV p-p on each pin).

All the baseband inputs must be externally dc biased. The recommended common-mode level is dependent on the version of the [ADL5375](#).

- [ADL5375-05](#): 500 mV
- [ADL5375-15](#): 1500 mV

LO INPUT

The LO input is designed to be driven from a single-ended source. The LO source is ac-coupled through a series capacitor to the LOIP pin while the LOIN pin is ac-coupled to ground through a second capacitor.

The typical LO drive level, which was used for the characterization of the [ADL5375](#), is 0 dBm.

Differential operation is also possible, in which case both sides of the differential LO source should be ac-coupled through a pair of series capacitors to the LOIP and LOIN pins.

RF OUTPUT

The RF output is available at the RFOUT pin (Pin 16), which can drive a 50 Ω load. The internal balun provides a low dc path to ground. In most situations, the RFOUT pin must be ac-coupled to the load.

07052-02B

OUTPUT DISABLE

The [ADL5375](#) incorporates an output disable pin feature that shuts down the output amplifier stage to isolate the modulator from the load. This output is disabled when the voltage on the DSOP exceeds 2 V. The output is enabled when the DSOP pin is either tied to ground or left unconnected.

Asserting DSOP further reduces LO leakage (see Figure 27 and Figure 52) and drives the broadband noise of the device down

to just above the KT thermal noise level. Asserting DSOP also reduces the supply current of the [ADL5375](#) from 200 mA to 127 mA.

The time delay between when DSOP pin going low and the output power being restored is approximately 200 ns. The time delay when DSOP going high and output being disabled is less than 100 ns.

APPLICATIONS INFORMATION

CARRIER FEEDTHROUGH NULLING

LO leakage results from minute dc offsets that occur on the differential baseband inputs. In an IQ modulator, non-zero differential offsets mix with the LO and result in LO leakage to the RF output. In addition to this effect, some of the signal power at the LO input couples directly to the RF output (this may be a result of bond-wire to bond-wire coupling or coupling through the silicon substrate). The net LO leakage at the RF output is the vector combination of the signals that appear at the output as a result of these two effects.

The device's nominal carrier feedthrough can be nulled by adding small external differential offset voltages on the I and Q inputs.

Nulling the carrier feedthrough is a multistep process. Initially, with the I-channel offset held constant (at 0 mV), the Q-channel offset is varied until a minimum LO leakage level is obtained. This Q-channel offset voltage is then held constant, while the offset on the I-channel is adjusted until a new minimum is reached. Through two iterations of this process, the LO leakage can be reduced to an arbitrarily low level. This level is only limited by the available offset voltage steps and by the modulator's noise floor. Figure 55 illustrates the typical relationship between LO leakage and dc offset at 1900 MHz. In this case, differential offset voltages of approximately +0.5 mV and -0.5 mV on the I and Q inputs, respectively, result in the lowest carrier feedthrough. It is important to note that the required offset nulling voltage changes in polarity and magnitude from device to device and overtemperature and frequency. To ensure that all devices in a mass production environment can be adequately nulled, an offset adjustment range of approximately ± 10 mV should be provided.

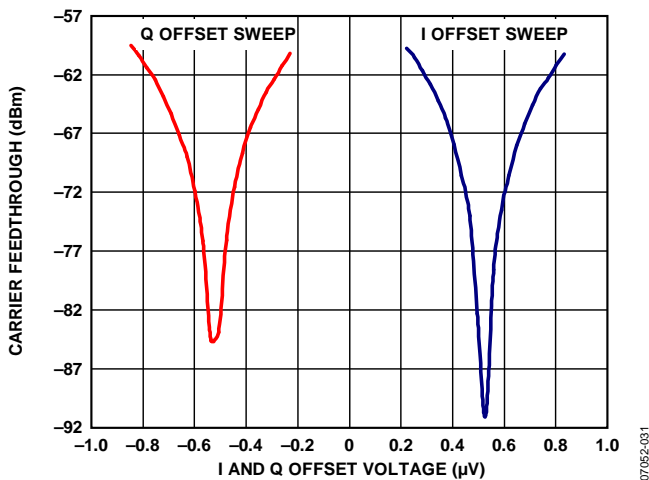

Figure 55. Example of Typical Carrier Feedthrough vs. DC Offset Voltage

It is important to note that the carrier feedthrough is not affected by the dc bias levels (also called the common-mode level) on the I and Q inputs. A differential offset voltage must be applied, so after nulling, the average voltage on the IP and

IN inputs can be slightly different. Using Figure 55 as an example, after LO leakage nulling, the average dc level on IP and IN can be 500.25 mV and 499.75 mV.

The same applies to the Q-channel. For the ADL5375-15, the same theory applies except that

$$V_{IBBP} = V_{IBBN} = 1500 \text{ mV.}$$

It is often desirable to perform a one-time carrier null. This is usually performed at a given frequency. After this factory calibration, the IQ modulator operates over a frequency range on each side of the calibration frequency. The nulled LO leakage level degrades somewhat because the LO frequency is moved away from the calibration frequency. Despite this degradation, the overall LO leakage across a frequency band can be expected to be better than when no nulling is performed. This assumes an operating frequency band that is in the 30 MHz to 60 MHz range.

LO leakage nulling is discussed further in AN-1039, *Correcting Imperfections in IQ Modulators to Improve RF Signal Fidelity*.

SIDEBAND SUPPRESSION OPTIMIZATION

Sideband suppression results from relative gain and relative phase offsets between the I-channel and Q-channel and can be suppressed through adjustments to those two parameters. Figure 56 illustrates how sideband suppression is affected by the gain and phase imbalances.

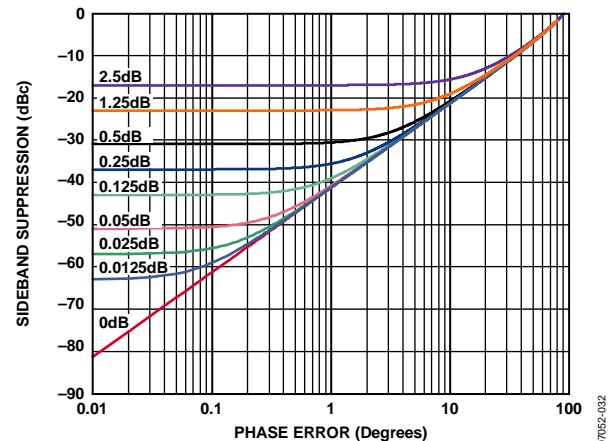

Figure 56. Sideband Suppression vs. Quadrature Phase Error for Various Quadrature Amplitude Offsets

Figure 56 underlines the fact that adjusting only one parameter improves the sideband suppression only to a point, unless the other parameter is also adjusted. For example, if the amplitude offset is 0.25 dB, improving the phase imbalance by better than 1° does not yield any improvement in the sideband suppression. For optimum sideband suppression, an iterative adjustment between phase and amplitude is required.

The sideband suppression nulling can be performed either through adjusting the gain for each channel or through the modification of the phase and gain of the digital data coming from the baseband signal processor.

Sideband suppression is discussed further in [AN-1100, Wireless Transmitter IQ Balance and Sideband Suppression](#), as well as in [AN-1039, Correcting Imperfections in IQ Modulators to Improve RF Signal Fidelity](#).

INTERFACING THE ADF4350 PLL TO THE ADL5375

With an output frequency range of 137.5 to 4.4 GHz, a high performance integrated VCO and an LO output power level that can be programmed from -4 dBm to +5 dBm, the [ADF4350](#) wideband synthesizer is ideally suited to drive the [ADL5375](#) LO port.

Care must be taken to adequately suppress the harmonics of the LO signal from the PLL. VCOs typically have a third harmonic power of approximately -10 dBc. A large third harmonic on the LO degrades the quality of the quadrature generation inside the IQ Modulator. The third harmonic should be suppressed to a level of -30 dBc or lower to prevent quadrature degradation. So approximately 20 dB of attenuation is required to get the third harmonic below -30 dBc. Figure 57 shows PLL modulator interfaces schematic that for this operation at four different frequencies, and Table 4 shows the optimized components value

of Figure 57. Because filtering of the third harmonic is most critical, and to ensure wide frequency range coverage, the 3 dB corner of the filters have been set to approximately 1.2~1.5 times the maximum desired LO frequency. A Chebyshev filter topology at 100 Ω differential source impedance and 50 Ω differential load impedance was used for optimal performance.

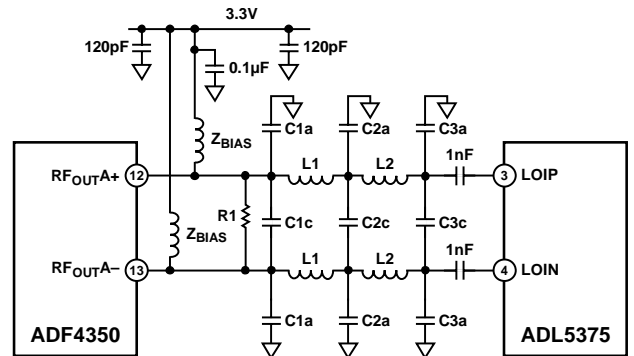

Figure 57. PLL-Modulator Interface Schematic

Table 4. PLL Modulator Interface Components Values (DNI = Do Not Insert)

| Frequency Range (MHz) | Zbias (nH) | R1 (Ω) | L1 (nH) | L2 (nH) | C1a (pF) | C1c (pF) | C2a | C2c (pF) | C3a (pF) | C3c (pF) |
|-----------------------|------------|--------|---------|---------|----------|----------|-----|----------|----------|----------|
| 500 to 1300 | 27 | 100 | 3.9 | 3.9 | DNI | 4.7 | DNI | 5.6 | DNI | 3.3 |
| 850 to 2450 | 19 | 100 | 2.7 | 2.7 | 3.3 | DNI | 4.7 | DNI | 3.3 | DNI |
| 1250 to 2800 | 7.5 | 100 | 0 Ω | 3.6 | DNI | DNI | 2.2 | DNI | 1.5 | DNI |
| 2800 to 4400 | 3.9 | 100 | 0 Ω | 0 Ω | DNI | DNI | DNI | DNI | DNI | DNI |

The two pull-up inductors of the Zbias provide two 50 Ω source impedances in combination with R1 resistor in parallel for the filter. While the ADL5375 is specified to be driven by a single-ended LO, the LOIP and LOIN input pins are naturally differential. Therefore, the differential LO drive from the ADF4350 is more desirable.

The output power from the ADF4350 can be set to -4 dBm, -1 dBm, +2 dBm, and +5 dBm using Register 4 Bits[D2:D1] and -6 dBm to +7 dBm LO drive level for ADL5375 is recommended.

If the physical distance between the PLL and the IQ modulator is significant, the filter should be placed adjacent to the IQ modulator, and two 50 Ω traces should be run between the devices (since there is a 50 Ω impedance looking from each of the filter inputs back to each of the PLL outputs).

The ADL5375 evaluation board can be reconfigured for differential drive and also includes component pads in its LO path to accommodate a harmonic filter. The ADF4350 evaluation board can also be configured to provide a differential output and can be connected directly to the ADL5375 evaluation board.

Optimizing the interface between a PLL LO and I/Q modulator is discussed further in CN-0134 Broadband Low EVM Direct Conversion Transmitter: How to Optimize the Interface Between a PLL LO and I/Q Modulator.

DAC MODULATOR INTERFACING

Driving the ADL5375-05 with a TXDAC®

The ADL5375-05 is designed to interface with minimal components to members of the Analog Devices, Inc. TxDAC families. These dual-channel differential current output DACs feature an output current swing from 0 mA to 20 mA. The interface described in this section can be used with any DAC that has a similar output.

An example of an interface using the AD9122 TxDAC is shown in Figure 58. The baseband inputs of the ADL5375-05 require a dc bias of 500 mV. The nominal midscale current on each of the outputs of the AD9122 is 10 mA. Therefore, a single 50 Ω resistor to ground from each of the DAC outputs results in an average current of 10 mA flowing through each of the resistors, thus producing the desired 500 mV dc bias for the inputs to the ADL5375-05.

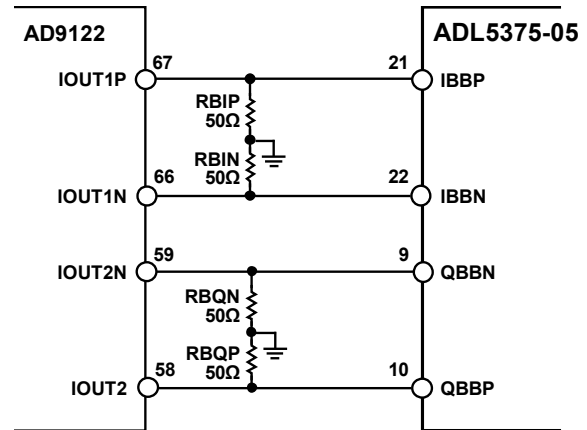

Figure 58. Interface Between the AD9122 and ADL5375-05 with 50 Ω Resistors to Ground to Establish the 500 mV DC Bias for the ADL5375-05 Baseband Inputs

The AD9122 output currents have a swing that ranges from 0 mA to 20 mA. With the 50 Ω resistors in place, the ac voltage swing going into the ADL5375-05 baseband inputs ranges from 0 V to 1 V. A full-scale sine wave out of the AD9122 can be described as a 1 V p-p single-ended (or 2 V p-p differential) sine wave with a 500 mV dc bias.

Limiting the AC Swing

There are situations in which it is desirable to reduce the ac voltage swing for a given DAC output current. This can be achieved through the addition of another resistor to the interface. This resistor is placed in the shunt between each side of the differential pair, as shown in Figure 59. It has the effect of reducing the ac swing without changing the dc bias already established by the 50 Ω resistors.

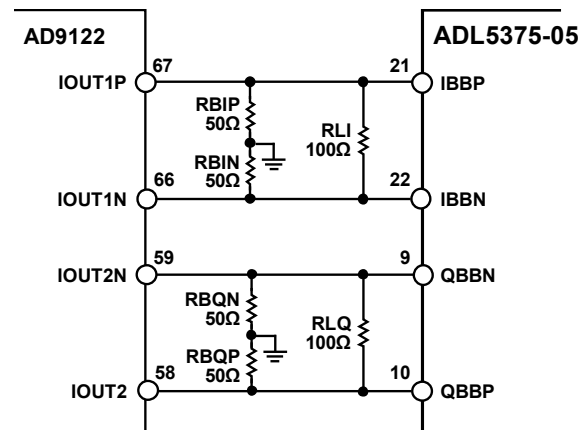

Figure 59. AC Voltage Swing Reduction Through the Introduction of a Shunt Resistor Between Differential Pair

The value of this ac voltage swing limiting resistor is chosen based on the desired ac voltage swing. Figure 60 shows the relationship between the swing-limiting resistor and the peak-to-peak ac swing that it produces when 50 Ω bias-setting resistors are used. The differential peak-to-peak swing at the modulator input is

$$V_{SIGNAL} = I_{FS} \times \frac{[2 \times R_B \times R_L]}{[2 \times R_B + R_L]}$$

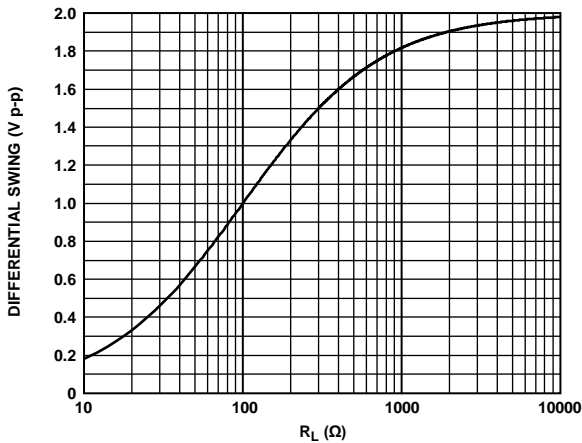

Figure 60. Relationship Between the AC Swing-Limiting Resistor and the Peak-to-Peak Voltage Swing with 50 Ω Bias-Setting Resistors

Filtering

It is necessary to place an antialiasing filter between the DAC and modulator to filter out Nyquist images, common mode noise, and broadband DAC noise. The interface for setting up the biasing and ac swing discussed in the Limiting the AC Swing section lends itself well to the introduction of such a filter. The filter can be inserted between the dc bias setting resistors and the ac swing-limiting resistor. With this configuration, the dc bias setting resistors and the signal scaling resistors conveniently set the source and load resistances for the filter.

Figure 61 shows a third-order, Bessel low-pass filter with a 3 dB frequency of 10 MHz. Matching input and output impedances make the filter design easier, so the shunt resistor chosen is 100 Ω, producing an ac swing of 1 V p-p differential. The frequency response of this filter is shown in Figure 62.

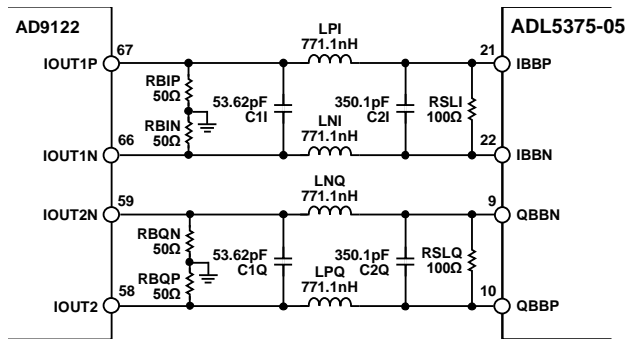

Figure 61. DAC Modulator Interface with 10 MHz Third-Order, Bessel Filter

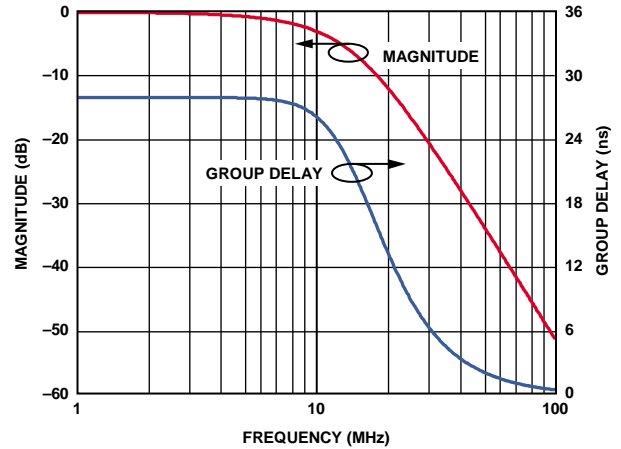

Figure 62. Frequency Response for DAC Modulator Interface with 10 MHz Third-Order Bessel Filter

Complex IF Operation

The ADL5375 can be used with a DAC, generating a complex-IF (CIF), as well as a zero-IF signal (ZIF). The -1 dB bandwidth of the ADL5375 is approximately more than 400 MHz (Figure 63 and Figure 64 show the baseband frequency response of the ADL5375, facilitating high CIF and providing sufficient flat bandwidth for digital predistortion (DPD) algorithms). Using a CIF places the LO leakage and the undesired sideband outside the signal band at the modulator output where they can be easily removed with a bandpass filter.

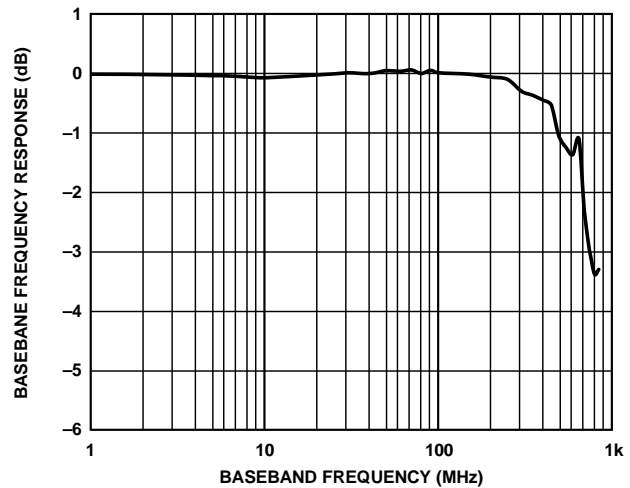

Figure 63. ADL5375-05 Baseband Frequency Response Normalized to Response for 1 MHz

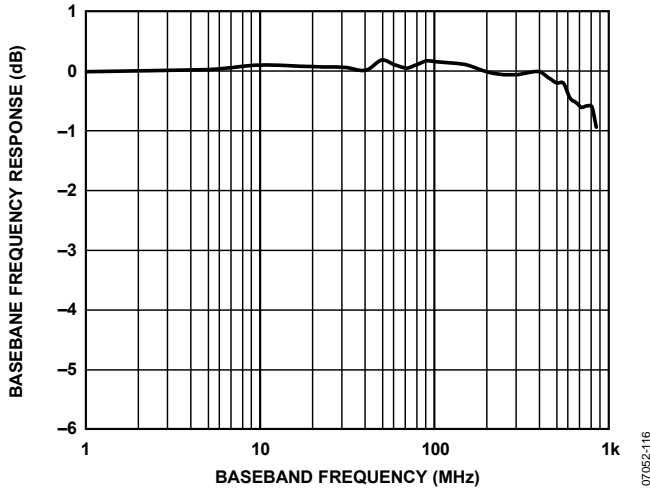

Figure 64. ADL5375-15 Baseband Frequency Response Normalized to Response for 1 MHz

In CIF applications, a low-pass filter between the DAC and modulator is still favored to filter out images, noises discussed in the Filtering section as well as to preserve dc bias level from DAC to ADL5375-05. Figure 65 shows a fifth order Butterworth filter with a 300 MHz corner frequency and the frequency response of this filter is shown in Figure 66.

Even a purely differential filter can work well, splitting the filter capacitors into two and grounding at filter topology as like C2 and C4 in Figure 65 divert common mode currents to ground and result in additional common-mode rejection of high frequency signals to a purely differential filter.

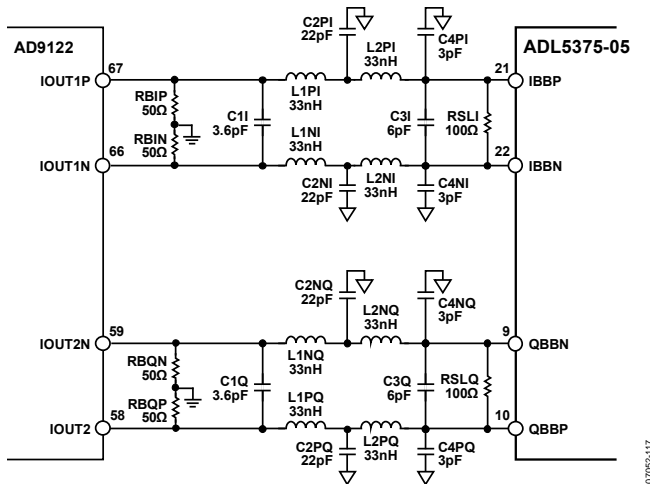

Figure 65. Recommended DAC Modulator Interface Topology with FC = 300 MHz Fifth-Order, Butterworth Filter

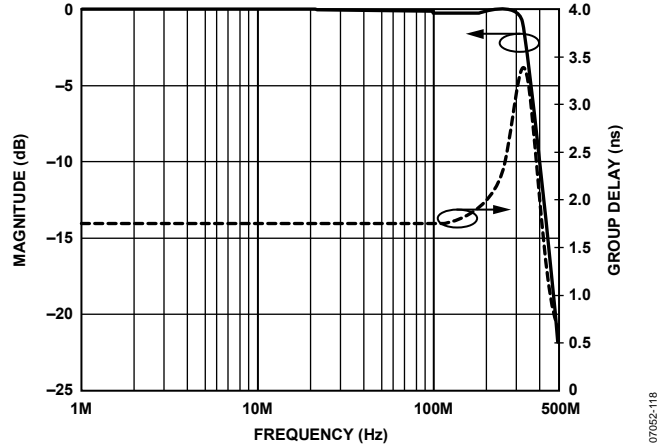

Figure 66. Frequency Response for DAC Modulator Interface with 300 MHz Fifth-Order Butterworth Filter

Driving the ADL5375-15 with a TXDAC

The ADL5375-15 requires a 1500 mV dc bias and therefore requires a slightly more complex interface that performs a dc level shift on the baseband signals. It is necessary to level-shift the DAC output from a 500 mV dc bias to the 1500 mV dc bias that the ADL5375-15 requires.

Level-shifting can be achieved with either a passive network or an active circuit. A passive network of resistors is shown in Figure 67. In this network, the dc bias of the DAC remains at 500 mV while the input to the ADL5375-15 is 1500 mV. It should be noted that this passive level-shifting network introduces approximately 2 dB of loss in the ac signal.

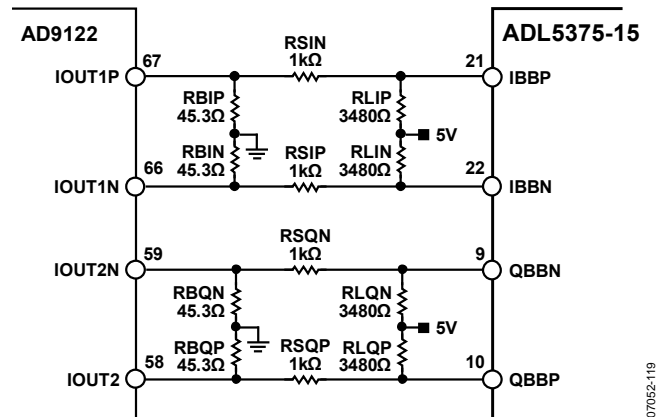

Figure 67. Passive Level-Shifting Network For Biasing ADL5375-15 from TxDAC

The active level shifting circuit involves the use of the ADA4938 dual-differential amplifier. This device has a V_{OCM} pin that sets the output dc bias. Through this pin, the output common-mode of the amplifier can be easily set to the requisite 1.5 V for biasing the ADL5375-15 baseband inputs.

Using the AD9122 DAC For Carrier Feedthrough and Unwanted Sideband Nulling

The AD9122 features an auxiliary DACs (Register 0x42, Register 0x43, Register 0x46, and Register 0x47) or the digital dc offset adjustments (Register 0x3C through Register 0x3F) that can be used to null the carrier feedthrough by applying the dc offset voltage at each main DAC channels. Unwanted sideband suppression can be done by adjusting the I/Q phase (Register 0x38 through Register 0x3B) and DAC FS (Register 0x40 and Register 0x44) registers.

GSM/EDGE OPERATION

The performance of the ADL5375-05 in a Multi-Carriers GSM/EDGE environment is shown in Figure 68 and Figure 69.

Figure 68 illustrates the 6 MHz offset noise floor of the ADL5375-05 at the six carriers MCGSM/EDGE(8-PSK) operating condition vs. output power, and Figure 69 demonstrates IMD performance of the same six carriers MCGSM/EDGE(8-PSK) for the ADL5375-05 at 950 MHz. It is configured, as shown at Figure 65, for this measurement. The AD9122 is set at -3 dB digital FS back off, $F_{DATA} = 368.64$ MSPS, $2\times$ interpolation, and PLL and inverse sync off. Complex IF at 174.32 MHz is generated at NCO of the AD9122 and fed into the ADL5375-05 through a fifth order Butterworth filter. Special care must be taken not to be affected by the noise power of images through proper DAC setup at the selection of IF Frequency, F_{DATA} , F_{DAC} , and so on for such a low IMD and noise level measurement. Be sure to load clean LO signals and use equipment that allows enough dynamic range capability and noise correction feature to compensated the noise originated by equipment itself.

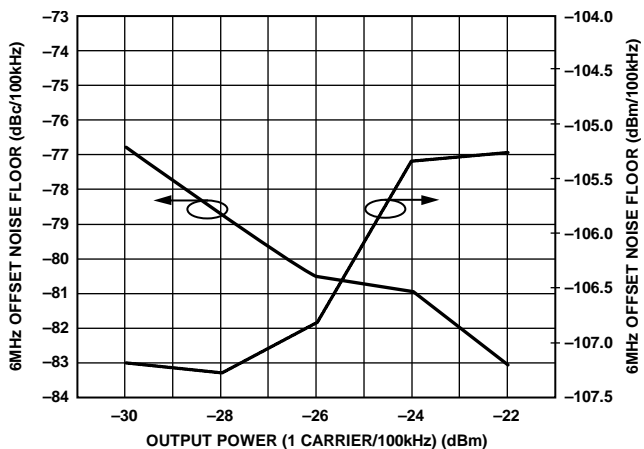

Figure 68. ADL5375-05 GSM/EDGE(8-PSK) 6 Carriers 6 MHz Offset Noise Floor at 950 MHz vs Output Power(1 Carrier/100 KHz), LO Drive = 0 dBm

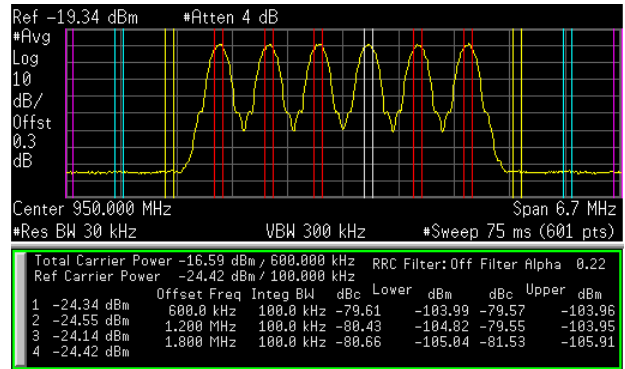

Figure 69. ADL5375-05 GSM/EDGE(8-PSK) 6 Carriers Adjacent and Alternate Channel Power Performance at 950 MHz; Output Power(1 Carrier/100 KHz) = -24.4 dBm LO Drive = 0 dBm

The performance of the ADL5375 in a GSM/EDGE environment is shown in Figure 70 and Figure 71.

Figure 70 illustrates the 6 MHz offset noise of the ADL5375-05 and ADL5375-15 vs. output power at 940 MHz. Figure 71 demonstrates how the 6 MHz offset noise is affected by variations in LO drive level for both version of the ADL5375 at 940 MHz.

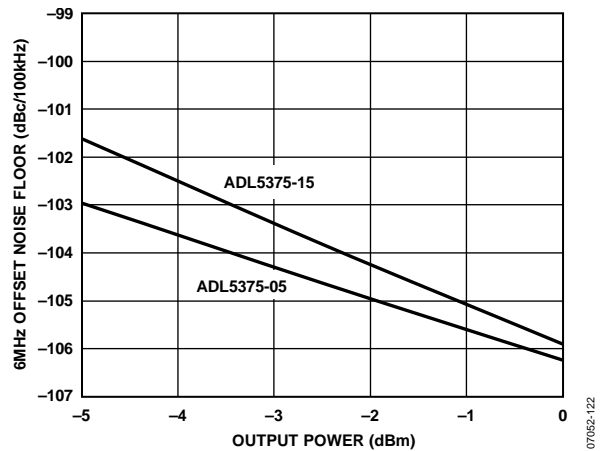

Figure 70. GSM/Edge (8-PSK) 6 MHz Offset Noise at 940 MHz vs. Output Power, LO Drive = 0 dBm



Figure 71. GSM/Edge (8-PSK) 6 MHz Offset Noise at 940 MHz vs. LO Drive, Output Power = 0 dBm

W-CDMA OPERATION

The ADL5375 is suitable for W-CDMA operation. Figure 72 and Figure 73 show the adjacent and alternate channel power ratios for the ADL5375-05 and ADL5375-15, respectively, at an LO frequency of 2140 MHz.

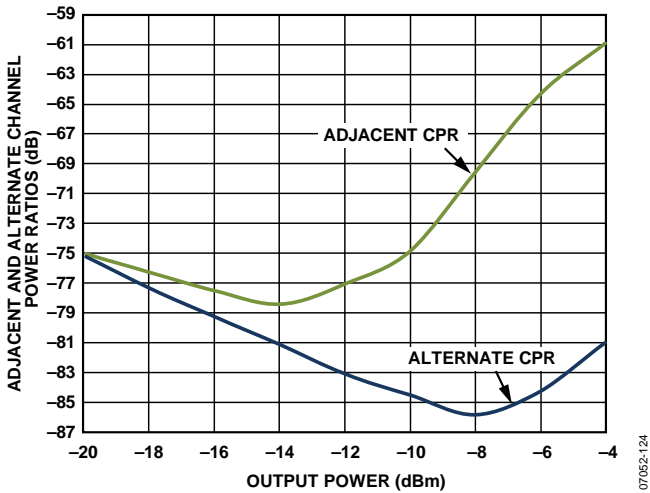

Figure 72. ADL5375-05 Single-Carrier W-CDMA Adjacent and Alternate Channel Power vs. Output Power at 2140 MHz; LO Power = 0 dBm

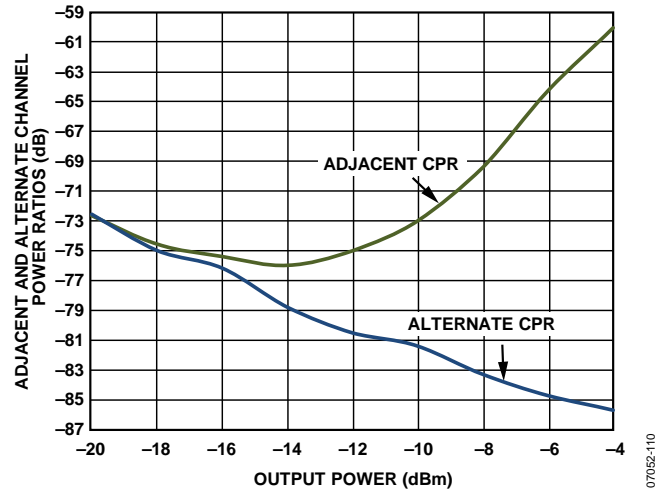

Figure 73. ADL5375-15 Single-Carrier W-CDMA Adjacent and Alternate Channel Power vs. Output Power at 2140 MHz; LO Power = 0 dBm

Figure 72 and Figure 73 show that both versions of the ADL5375 are able to deliver about or better than -73 dB ACPR at an output power of -10 dBm.

Figure 74 illustrate the sensitivity of the EVM to variations in LO drive at 2140 MHz for the ADL5375-05 and ADL5375-15.

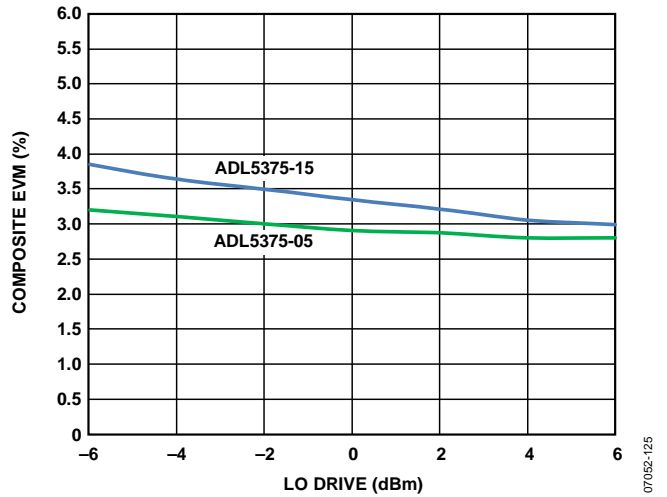

Figure 74. Single Carrier W-CDMA Composite EVM vs. LO Drive at 2140 MHz; Output Power = -10 dBm

The EVM exhibits improvements with a local feedthrough nulling operation.

LO GENERATION USING PLLS

Analog Devices has a line of PLLs that can be used for generating the LO signal. Table 5 lists the PLLs together with their maximum frequency and phase noise performance.

Table 5. Analog Devices PLL Selection

| Part | Frequency, f_{IN} (MHz) | Phase Noise at 1 kHz Offset and 200 kHz PFD (dBc/Hz) |
|-------------------------|---------------------------|--|
| ADF4110 | 550 | -91 at 540 MHz |
| ADF4111 | 1200 | -87 at 900 MHz |
| ADF4112 | 3000 | -90 at 900 MHz |
| ADF4113 | 4000 | -91 at 900 MHz |
| ADF4116 | 550 | -89 at 540 MHz |
| ADF4117 | 1200 | -87 at 900 MHz |
| ADF4118 | 3000 | -90 at 900 MHz |

The [ADF4350](#) is a fractional-N PLL which offers broadband operation from 137.5 MHz to 4.4 GHz and contains an integrated high performance VCO.

Table 6. ADF4350 Phase Noise at Various Frequencies

| Part | Frequency (MHz) | Phase Noise at 10 kHz (dBc/Hz) 25 MHz PFD, 40 KHz Loop BW |
|-------------------------|-----------------|---|
| ADF4350 | 2200 | -97 |
| ADF4350 | 3300 | -92 |
| ADF4350 | 4400 | -90 |

TRANSMIT DAC OPTIONS

The [AD9122](#) recommended in the previous sections of this data sheet is by no means the only DAC that can be used to drive the [ADL5375](#). There are other appropriate DACs, depending on the level of performance required. Table 7 lists the dual TxDAC offered by Analog Devices.

Table 7. Dual TxDAC Selection

| Part | Resolution (Bits) | Update Rate (MSPS Minimum) |
|-------------------------|-------------------|----------------------------|
| AD9709 | 8 | 125 |
| AD9761 | 10 | 40 |
| AD9763 | 10 | 125 |
| AD9765 | 12 | 125 |
| AD9767 | 14 | 125 |
| AD9773 | 12 | 160 |
| AD9775 | 14 | 160 |
| AD9777 | 16 | 160 |
| AD9776 | 12 | 1000 |
| AD9778 | 14 | 1000 |
| AD9779A | 16 | 1000 |

All DACs listed have nominal bias levels of 0.5 V and use the same simple DAC modulator interface that is shown in Figure 75.

MODULATOR/DEMODULATOR OPTIONS

Table 8 lists other Analog Devices modulators and demodulators.

Table 8. Modulator/Demodulator Options

| Part No. | Modulator/Demodulator | Frequency Range (MHz) | Comments |
|-------------------------|-----------------------|-----------------------|----------------------|
| AD8345 | Modulator | 140 to 1000 | External quadrature |
| AD8346 | Modulator | 800 to 2500 | |
| AD8349 | Modulator | 700 to 2700 | |
| ADL5390 | Modulator | 20 to 2400 | |
| ADL5385 | Modulator | 50 to 2200 | Includes VVA and AGC |
| ADL5386 | Modulator | 50 to 2200 | |
| ADL5370 | Modulator | 300 to 1000 | |
| ADL5371 | Modulator | 500 to 1500 | |
| ADL5372 | Modulator | 1500 to 2500 | |
| ADL5373 | Modulator | 2300 to 3000 | |
| ADL5374 | Modulator | 3000 to 4000 | |
| AD8347 | Demodulator | 800 to 2700 | |
| AD8348 | Demodulator | 50 to 1000 | |
| ADL5387 | Demodulator | 50 to 2000 | |
| ADL5380 | Demodulator | 400 to 6000 | |
| ADL5382 | Demodulator | 700 to 2700 | |
| AD8340 | Vector modulator | 700 to 1000 | |
| AD8341 | Vector modulator | 1500 to 2400 | |

EVALUATION BOARD

Populated RoHS-compliant evaluation boards are available for evaluation of the [ADL5375](#). The [ADL5375](#) package has an exposed paddle on the underside. This exposed paddle should be soldered to the board for good thermal and electrical grounding. The evaluation board is designed to minimize LO feedthrough to RFOUT through PCB by placing LO block on the underside. And it can be configured to allow differential LO driving through balun or direct interfacing to the PLL evaluation board. It also reserves component pads in its LO path to accommodate a harmonic filter. One side placement of baseband inputs is to interface directly to DAC evaluation board. The [ADL5375](#) evaluation board also includes an RF driver amplifier. The modulator output can be measured directly at the MOD_OUT SMA connector. Alternatively, by removing R1, and installing a

0 Ω resistor in the R2 pad, the modulator's output can be fed to the RF driver amplifier.

The evaluation board ships, installed with an [ADL5320](#) driver amplifier (400 MHz to 2700 MHz RF driver amplifier). This device requires external matching components (C100 and C101) and is tuned by default for operation from 1805 MHz to 2170 MHz. For details on tuning component values for other frequencies, please refer to the [ADL5320](#) data sheet (the driver amplifier section of the [ADL5375](#) Evaluation Board is identical to the [ADL5320](#) Evaluation Board). For higher frequency operation, the [ADL5320](#) should be replaced by the [ADL5321](#), which is specified to operate from 2.3 GHz to 4 GHz. If a broadband matched device is desired, the [ADL5601](#) (15 dB) or [ADL5602](#) (20 dB) broadband gain blocks can be used.

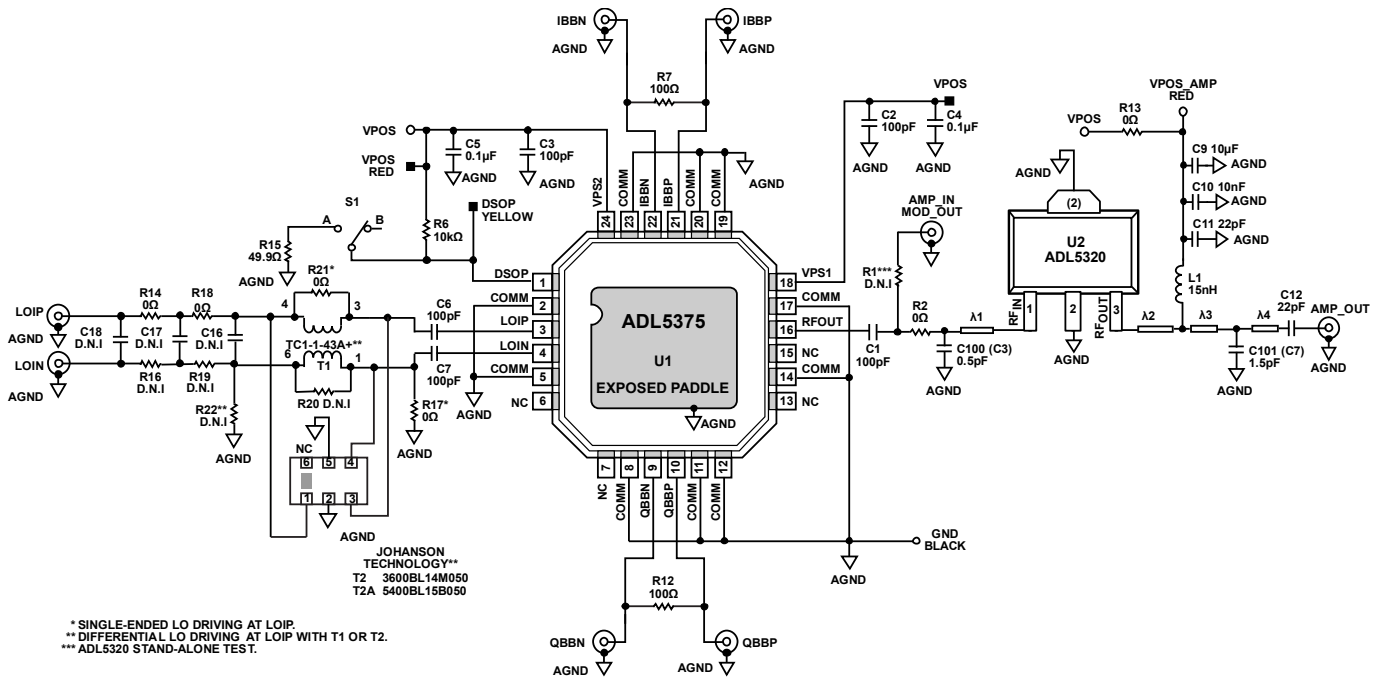

Figure 75. [ADL5375](#) Evaluation Board Schematic

07052-126

Table 9. Evaluation Board Description and Configuration Options

| Component | Description | Default Condition/Option Settings |
|---|---|--|
| VPOS, GND Test Points S1 Switch, R6, R15 | Power supply and ground test points for clip leads DSOP output disable select | Red = 5 V, black = GND Position A = output enabled Position B = output disabled R15 = 49.9 Ω (0603) R6 = 10 k Ω (0603) |
| R7, R12 C16 to C18, R14, R16, R18, R19 | AC limiting resistors LO input filter components | R7, R12 = 100 Ω (0603) R14, R18 = 0 Ω (0603) R16, R19, C16 to C18 = open (0603) |
| C6, C7 LOIP SMA, R17, R20, R21, R22, T1, T2, T2A | LO driving capacitor Single-ended local oscillator input | C6, C7 = 100 pF (0402) R17 = 0 Ω (0603) R20 = open (0402) R21 = 0 Ω (0402) R22 = open (0603) T1, T2, T2A = open |
| LOIN SMA, R16, R17, R19, R20, R21, R22, T1, T2, T2A | Optional differential LO input at LOIN | R16, R19 = 0 Ω (0603) R20, R21 = 0 Ω (0402) R17, R22 = open (0603) T1, T2, T2A = open |
| LOIP SMA, T1 (or T2, T2A), R17, R20, R21, R22 | Optional differential LO driving with Balun at LOIP | R17 = open (0603) R20, R21 = open (0402) R22 = 0 Ω (0603) T1 = TC1-1-43A+ or T2 = 3600BL14M050 or T2A = 5400BL15B050 |
| C100, C101 | Frequency tuning capacitors for RF driver amplifier Refer to the ADL5320 datasheet for the exact position according to the frequency | Tuning for 1805 MHz to 2170 MHz C100 = 0.5 pF (0402) C101 = 1.5 pF (0402) |
| C1 | AC-coupling capacitor connects ADL5375 RF output to MOD_OUT RF connector or to ADL5320 RF input | C1 = 100 pF (0402) |
| R1 | Resistor connects ADL5375 RF output to MOD_OUT (AMP_IN) SMA To check ADL5375 performance itself, a 0 Ω should be inserted at R1 and open R2. | R1 = open (0402) |
| R2 | To check ADL5320 performance itself, a 0 Ω should be inserted at R1 and R2 Resistor connects ADL5375 RF output to ADL5320 RF input | R2 = 0 Ω (0402) |
| U1 | ADL5375 quadrature modulator | ADL5375-05 or ADL5375-15 |
| U2 | SOT-89 RF driver amplifier | ADL5320 |
| L1 | DC bias Inductor | L1 = 15 nH(0603) |
| C2, C3, C4, C5, C9, C10, C11 | Power supply bypassing capacitors | C2, C3 = 100 pF (0402) C4, C5 = 0.1 μ F (0402) C9 = 10 μ F (1206) C10 = 10 nF (0603) C11 = 22 pF (0603) |
| R13 | Resistor to share power supply between the ADL5375 and the ADL5320 . To turn on the ADL5320 , a 0 Ω resistor should be installed in this location. | R13 = 0 Ω (0603) |
| EP | Exposed Paddle. Connect to the ground plane via a low impedance path. | |

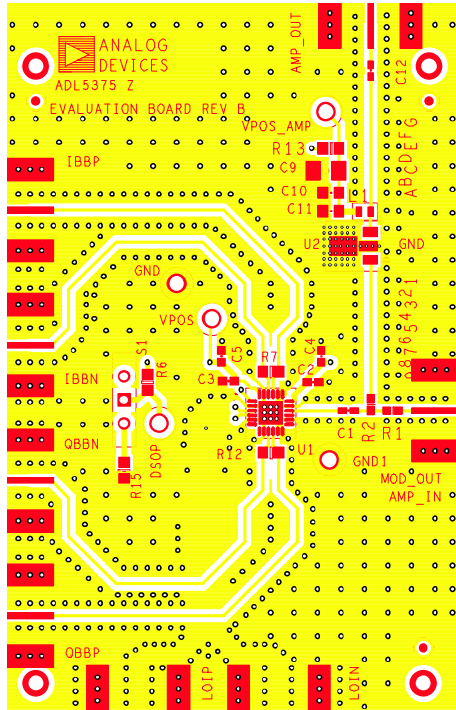

Figure 76. Evaluation Board Layout, Top Layer

07052-127

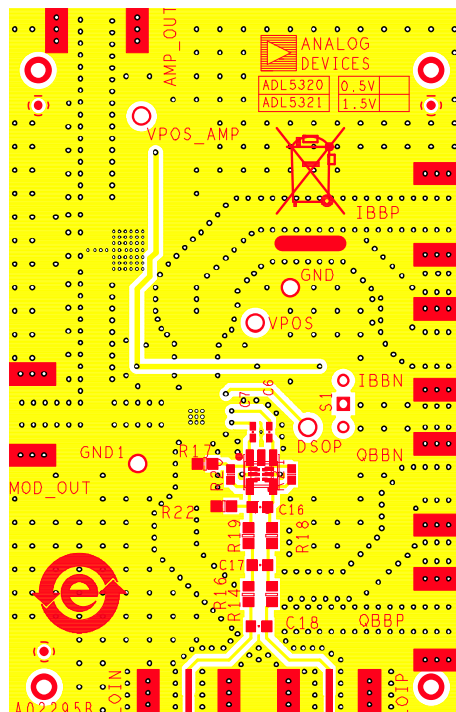

Figure 77. Evaluation Board Layout, Bottom Layer

07052-128

Thermal Grounding and Evaluation Board Layout

The package for the ADL5375 features an exposed paddle on the underside that should be well soldered to a low thermal and electrical impedance ground plane. This paddle is typically soldered to an exposed opening in the solder mask on the evaluation board. Figure 78 illustrates the dimensions used in the layout of the ADL5375 footprint on the ADL5375 Evaluation Board (1 mil. = 0.0254 mm).

Notice the use of nine via holes on the exposed paddle. These ground vias should be connected to all other ground layers on the evaluation board to maximize heat dissipation from the device package.

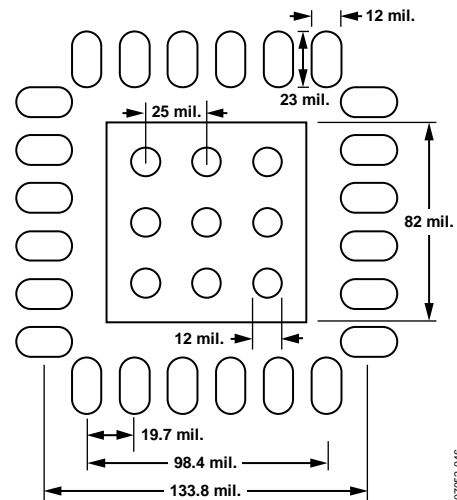

07052-046

Figure 78. Dimensions for Evaluation Board Layout for the ADL5375 Package

Under these conditions, the thermal impedance of the ADL5375 was measured to be approximately 30°C/W in still air.

CHARACTERIZATION SETUP

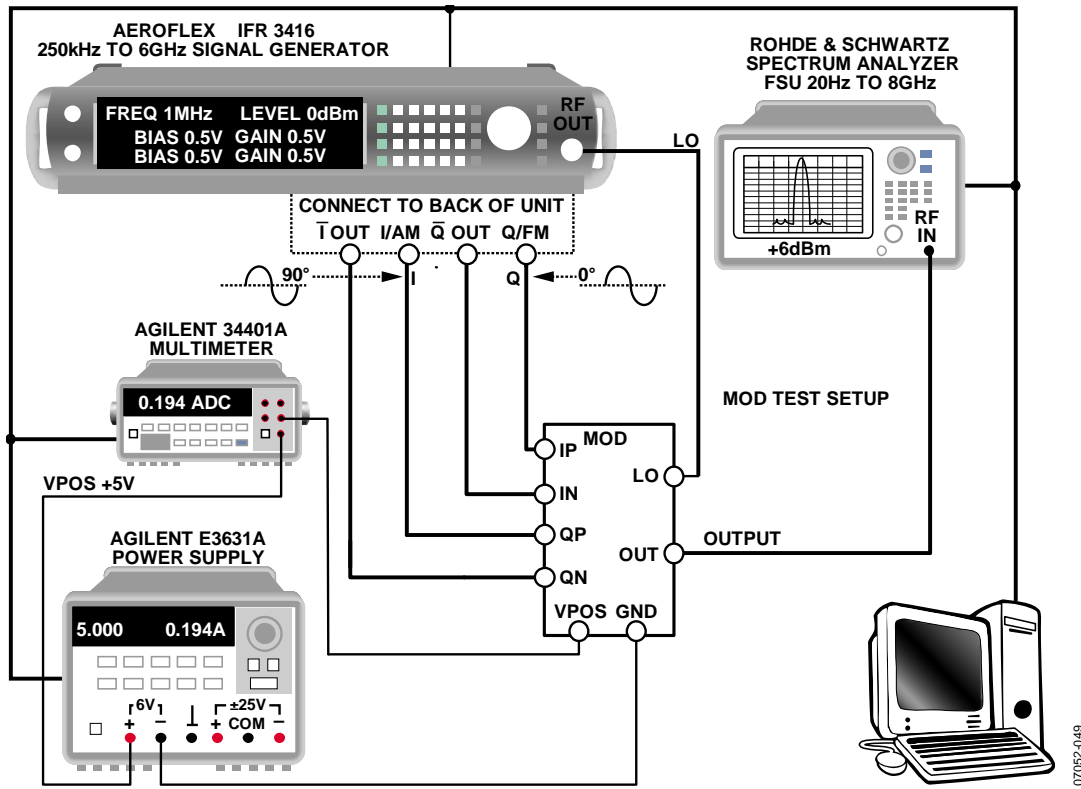

Figure 79. Characterization Bench Setup

The primary setup used to characterize the [ADL5375](#) is shown in Figure 79. This setup was used to evaluate the product as a single-sideband modulator. The aeroflex signal generator supplied the LO and differential I and Q baseband signals to the device under test (DUT). The typical LO drive was 0 dBm. The I-channel is driven by a sine wave, and the Q-channel is driven by a cosine wave. The lower sideband is the single-sideband (SSB) output.

The majority of characterization for the [ADL5375](#) was performed using a 1 MHz sine wave signal with a 500 mV ([ADL5375-05](#)) or 1500 mV ([ADL5375-15](#)) common-mode voltage applied to the baseband signals of the DUT. The baseband signal path was calibrated to ensure that the V_{I0S} and V_{Q0S} offsets on the baseband inputs were minimized as close as possible to 0 V before connecting to the DUT. See the Carrier Feedthrough Nulling section for the definitions of V_{I0S} and V_{Q0S} .

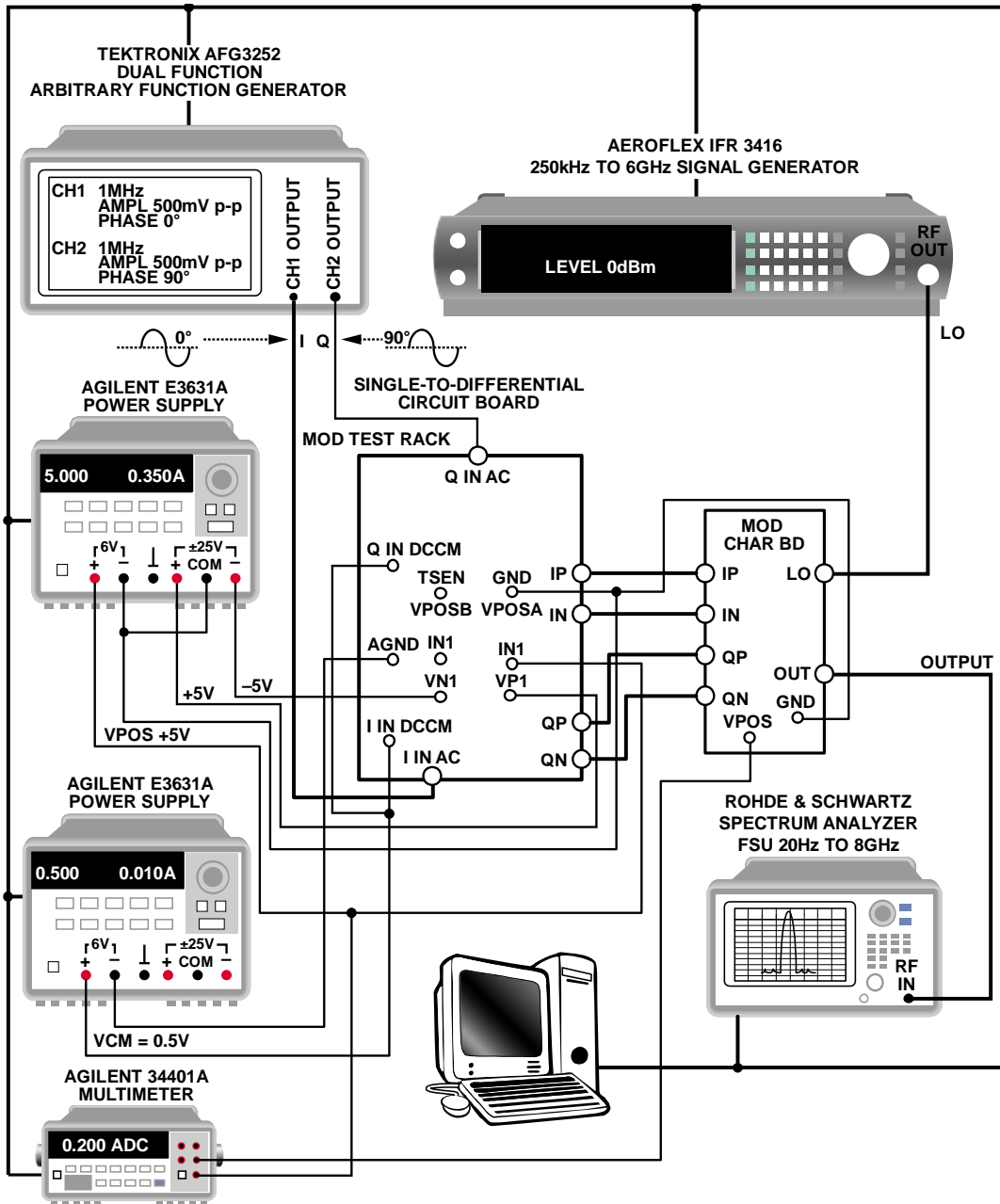

Figure 80. Setup for Baseband Frequency Sweep and Undesired Sideband Nulling

The setup used to evaluate baseband frequency sweep and undesired sideband nulling of the ADL5375 is shown in Figure 80. The interface board has circuitry that converts the single-ended I input and Q input from the arbitrary function generator to differential I and Q baseband signals with a dc bias of 500 mV

(ADL5375-05) or 1500 mV (ADL5375-15). Undesired sideband nulling was achieved through an iterative process of adjusting amplitude and phase on the Q-channel. See Sideband Suppression Optimization section for a detailed description on sideband nulling.

07052-950

OUTLINE DIMENSIONS

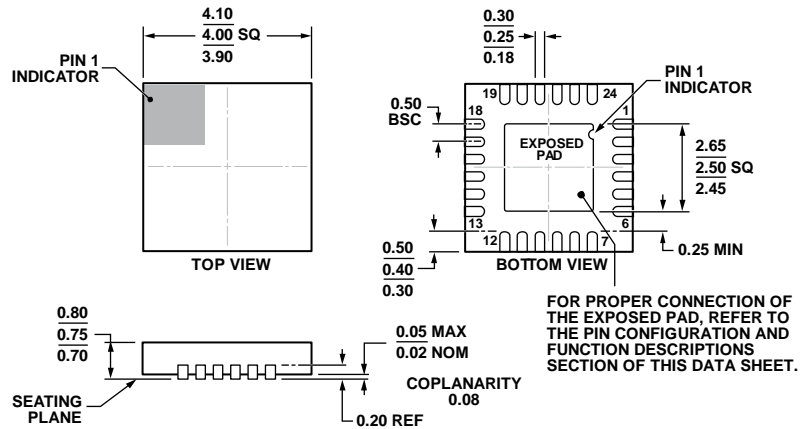

COMPLIANT TO JEDEC STANDARDS MO-220-WGGD.

Figure 81. 24-Lead Lead Frame Chip Scale Package [LFCSP_WQ]
4 mm × 4 mm Body, Very Very Thin Quad
(CP-24-7)
Dimensions shown in millimeters

04-12-2012-A

ORDERING GUIDE

| Model ¹ | Temperature Range | Package Description | Package Option | Ordering Quantity |
|--------------------|-------------------|------------------------------------|----------------|-------------------|
| ADL5375-05ACPZ-R7 | -40°C to +85°C | 24-Lead LFCSP_WQ, 7" Tape and Reel | CP-24-7 | 1,500 |
| ADL5375-05ACPZ-R2 | -40°C to +85°C | 24-Lead LFCSP_WQ, 7" Tape and Reel | CP-24-7 | 250 |
| ADL5375-05-EVALZ | | Evaluation Board | | |
| ADL5375-15ACPZ-R7 | -40°C to +85°C | 24-Lead LFCSP_WQ, 7" Tape and Reel | CP-24-7 | 1,500 |
| ADL5375-15ACPZ-WP | -40°C to +85°C | 24-Lead LFCSP_WQ, Waffle Pack | CP-24-7 | 64 |
| ADL5375-15-EVALZ | | Evaluation Board | | |

¹ Z = RoHS Compliant Part.

NOTES

Looking for pricing, stock, or lifecycle information?

Click below to explore more details on WIN SOURCE:

 [View ADL5375-05-EVALZ on WIN SOURCE](#)

 [Analog Devices Inc. Information](#)

Optimize Your Supply Chain with WIN SOURCE Solutions

-  Global Sourcing Solution
-  Obsolete Management
-  Cost Control Management
-  Shortage Management
-  Alternative Solution
-  Excess Inventory Management