

High-Performance Video Signal Switchers

Triple-circuit Video Switchers

BA7602F,BA7603F,BA7606F,BA7606FS,BA7607F,BA7609F,BA7627FV

No.11066EAT02

●Description

These video switching ICs, which contain two or three 2-input circuits, were developed for switching TV, DVD, and other video signals. Input pin formats can be selected from bias mode ($R=20\text{ k}\Omega$), sync-tip mode, and pedestal clamp mode. Having a large dynamic range and broad frequency characteristics, these switches are suited to a wide range of applications from audio signals to video signals.

●Features

- 1) Contain three 2-input, 1-output switch circuits
- 2) Power supply voltage (4.5~5.5 V)
- 3) Low power consumption
- 4) Good frequency characteristics
- 5) Large dynamic range
- 6) Bias input (BA7602F)
Sync-tip clamp input (BA7603F)
Pedestal clamp input (BA7606F, BA7606FS)
Bias input + sync-tip clamp input (BA7607F, BA7609F, BA7627FV)
- 7) Large input impedance (Typ. $20\text{ k}\Omega$)
- 8) Fast switching speed (Typ. 50ns)

●Applications

For switching TV, DVD, and Other video signals

●Line up matrix

Part No.	Circuit current (mA)	Built-in circuit	Input type	Distortion (%)	Maximum output level (V_{P-P})	Package
BA7602F	14.0	2 in 3 circuits	Bias	—	3.1	SOP16
BA7603F	13.0	2 in 3 circuits	Clamp	—	2.9	SOP16
BA7606F BA7606FS	15.0	2 in 3 circuits	Pedestal Clamp	—	2.6	SOP16/ SSOP-A16
BA7607F	12.5	2 in 3 circuits	Clamp 2 Bias1	0.007	3.0	SOP16
BA7609F	12.5	2 in 3 circuits	Clamp 1 Bias 2	0.007	3.0	SOP16
BA7627FV	12.5	2 in 3 circuits	Clamp 2 Bias1	0.007	3.0	SSOP-B16

●Absolute Maximum Ratings (Ta=25°C)

Parameter		Symbol	Ratings	Unit
Supply voltage		Vcc	9	V
Power dissipation	BA7602F BA7603F BA7606F BA7607F BA7609F	Pd	500 ^{*1}	mW
	BA7606FS		650 ^{*2}	
	BA7627FV		450 ^{*1}	
Operating temperature		Topr	-40~+85	°C
Storage temperature		Tstg	-55~+125	°C

*1 Deratings is done at 5.0mW/°C above Ta=25°C.(BA7603F, BA7606F, BA7607F, BA7609F, BA7627FV)

*2 Deratings is done at 6.5mW/°C above Ta=25°C.(BA7606FS)

●Operating Range (Ta=25°C)

Parameter	Symbol	Ratings			Unit
		Min.	Typ.	Max.	
Supply voltage	Vcc	4.5	5.0	5.5	V

●Electrical characteristics (Unless otherwise noted, Ta=25°C and Vcc=5.0V)

Parameter	Symbol	Limits (Typ.)						Unit	Conditions
		02F	03F	06F/ 06FS	07F	09F	27FV		
Circuit current	Icc	14.0	13.0	15.0	12.5		mA	—	
Maximum output level1	Clamp	Vom1	—	2.9	—	2.9		V _{P-P}	f=1kHz, THD=0.5%, with clamp
Maximum output level2	Bias	Vom2	3.1	—	—	3.0		V _{P-P}	f=1kHz, THD=0.5%, without clamp
Maximum output level U	Pedestal clamp	VomU	—	1.65		—		V _{P-P}	Dynamic range on positive side of clamp level
Maximum output level D	Pedestal clamp	VomD	—	0.95		—		V _{P-P}	Dynamic range on negative side of clamp level
Voltage gain	Gv	0						dB	f=1MHz, V _{IN} =1 V _{P-P}
Interchannel crosstalk	C _T	-65						dB	f=4.43MHz, V _{IN} =1 V _{P-P}
Frequency characteristic	Gf	0		-1		0		dB	10MHz/1MHz, V _{IN} = V _{P-P}
Total harmonic distortion	THD	—			0.007			%	f=1kHz, 1V _{p-p} , Bias type
CTL pin switching level	V _{TH}	2.5						V	H: IN1 L: IN2
Clamp input level	V _{ct}	L≤0.75			H≥2.2			V	Only BA7606F, BA7606FS

●Block diagram

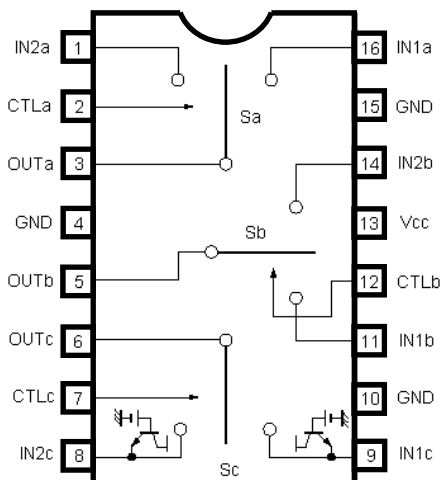
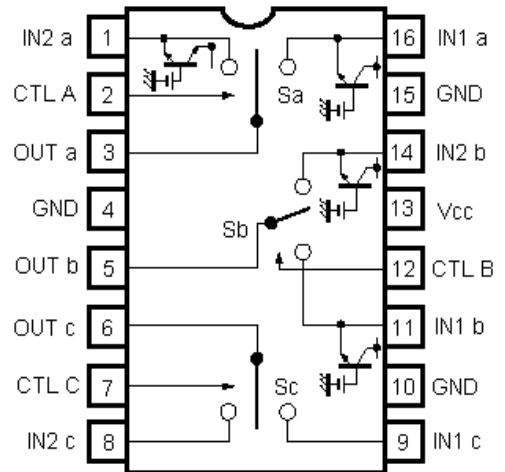
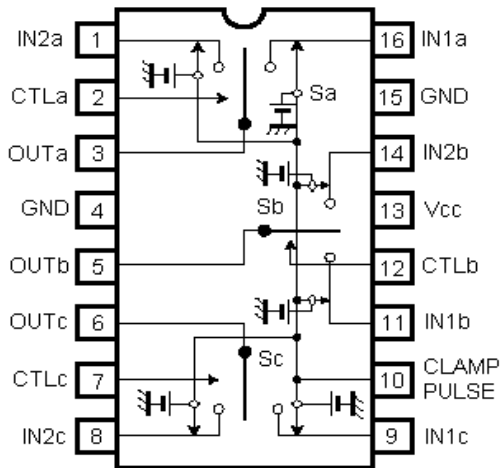
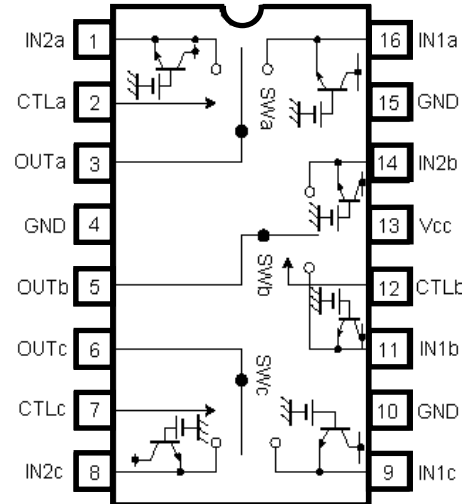
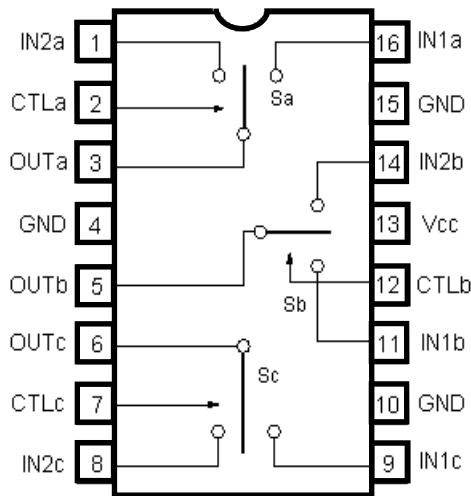

CTL pin settings

CTL	OUTPUT
L	IN2
H	IN1

●Reference data

Pin DC voltage(VCC=5V, Ta=25°C)

Pin No.	Pin DC voltage (V)				
	BA7602F	BA7603F	BA7606F BA7606FS	BA7607F BA7627FV	BA7609F
1	3.27	2.05	2.96	2.05	2.48
2	4.91	4.91	4.91	4.91	4.91
3	1.84	0.65	1.54	0.65	1.76
4	0	0	0	0	0
5	1.84	0.65	1.54	0.65	1.76
6	1.84	0.65	1.54	1.76	0.65
7	4.91	4.91	4.91	4.91	4.91
8	3.27	2.05	2.96	2.48	2.05
9	3.27	2.05	2.96	2.48	2.05
10	0	0	4.97	0	0
11	3.27	2.05	2.96	2.05	2.48
12	4.91	4.91	4.91	4.91	4.91
13	5.00	5.00	5.00	5.00	5.00
14	3.27	2.05	2.96	2.05	2.48
15	0	0	0	0	0
16	3.27	2.05	2.96	2.05	2.48

Input/Output impedance

Parameter		Limits (Typ.)				Unit
		02F	03F	06F/FS	07F/27FV 09F	
Input impedance	Bias	20k	—	—	20k	Ω
Input impedance	Clamp	—	1.7M			Ω
Output impedance		30		30*	30	Ω

*The 6pin output impedance in the BA7606F/FS is 130Ω.

● Measurement circuit 1/2 (BA7602F, BA7603F, BA7607F, BA7609F)

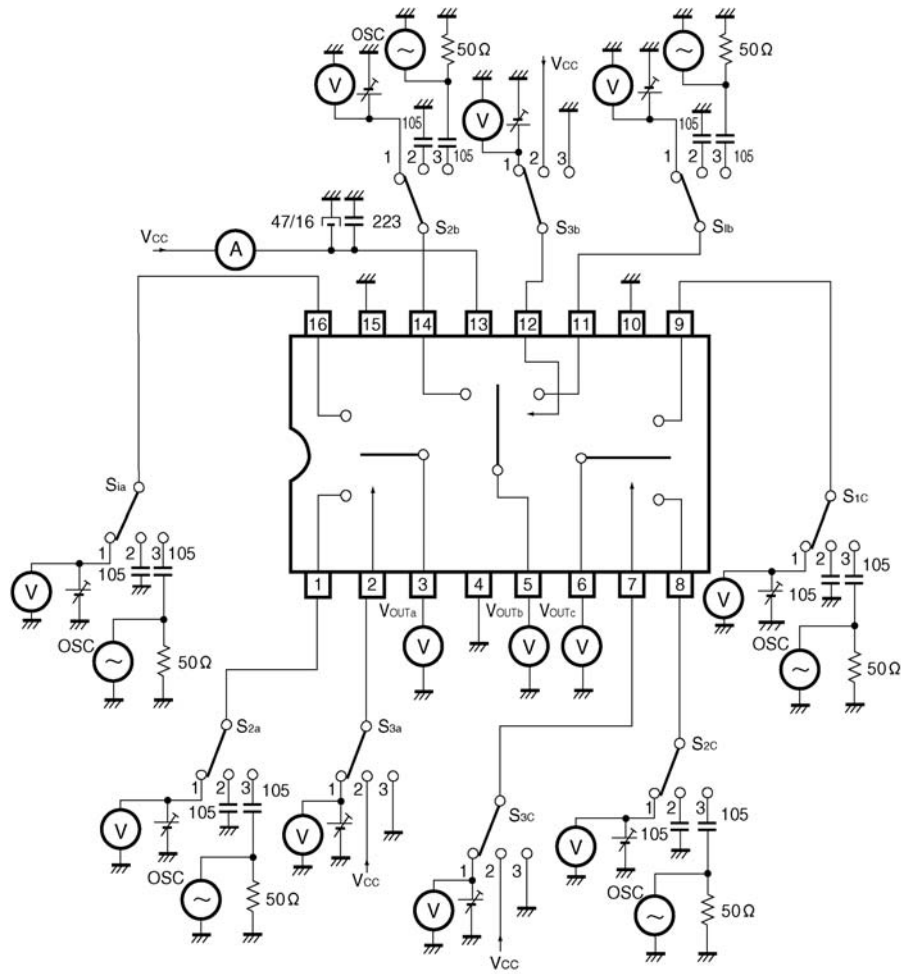

Fig.6 BA7602F, BA7603F, BA7607F, BA7609F, BA7627FV

● Measurement circuit 2/2 (BA7606F/FS)

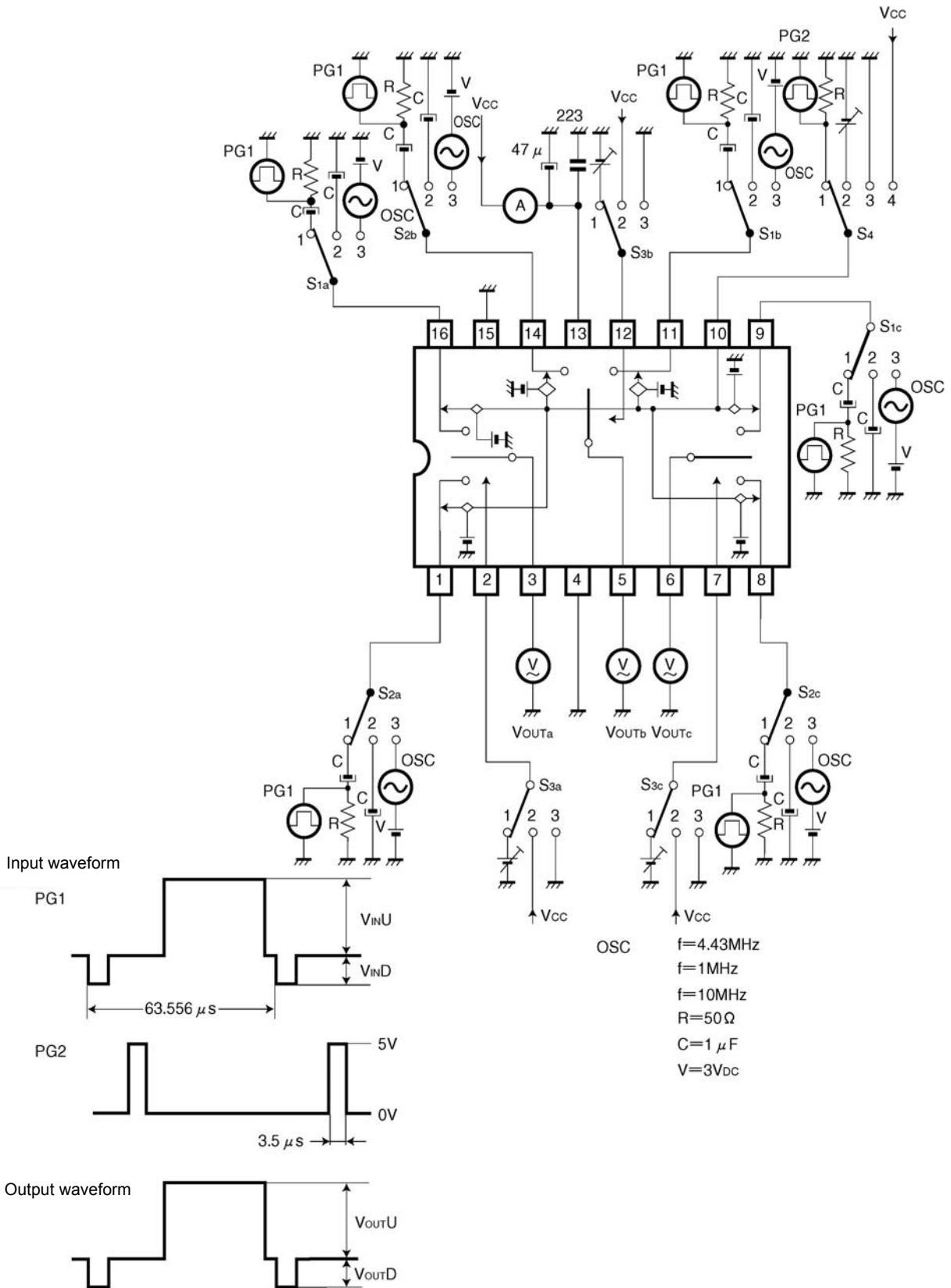

Fig.7 BA7606F, BA7606FS

●Reference data

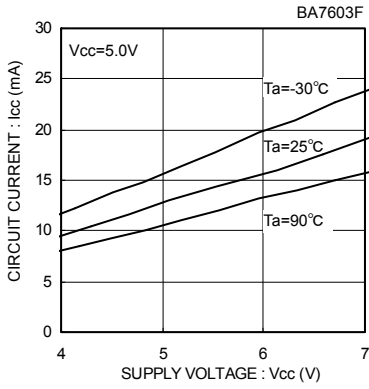

Fig.8 Circuit current vs. Supply voltage

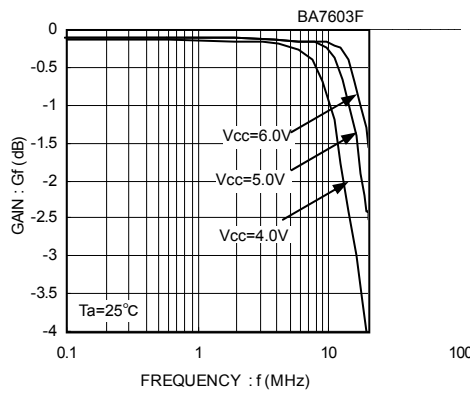

Fig.9 Frequency characteristics vs. Supply voltage

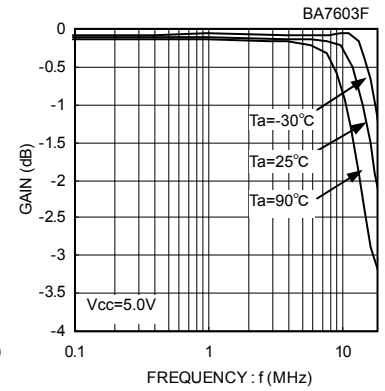

Fig.10 Frequency characteristics vs. temperature

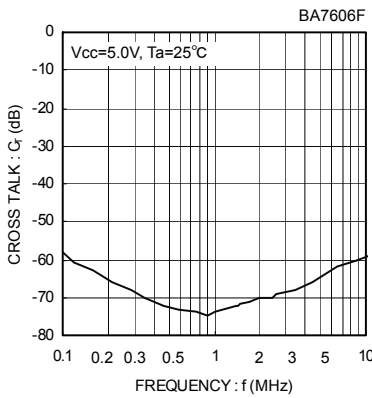

Fig.11 Interchannel crosstalk

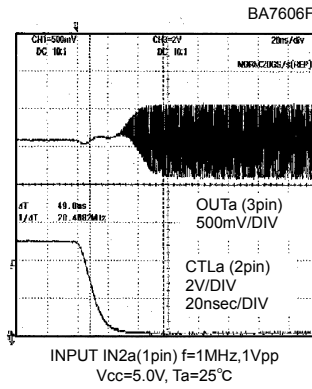

Fig.12 Switching characteristics1
OFF→ON

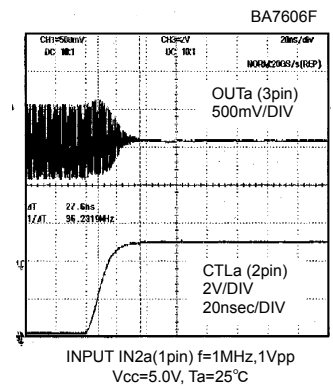
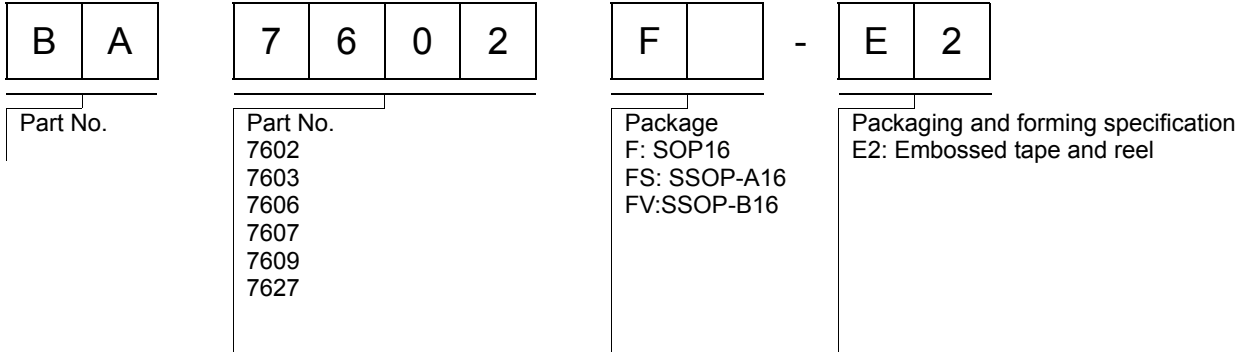

Fig.13 Switching characteristics2
ON→OFF

●Notes for use

- 1) Numbers and data in entries are representative design values and are not guaranteed values of the items.
- 2) Although we are confident in recommending the sample application circuits, carefully check their characteristics further when using them. When modifying externally attached component constants before use, determine them so that they have sufficient margins by taking into account variations in externally attached components and the Rohm LSI, not only for static characteristics but also including transient characteristics.
- 3) Absolute maximum ratings
If applied voltage, operating temperature range, or other absolute maximum ratings are exceeded, the LSI may be damaged. Do not apply voltages or temperatures that exceed the absolute maximum ratings. If you think of a case in which absolute maximum ratings are exceeded, enforce fuses or other physical safety measures and investigate how not to apply the conditions under which absolute maximum ratings are exceeded to the LSI.
- 4) GND potential
Make the GND pin voltage such that it is the lowest voltage even when operating below it. Actually confirm that the voltage of each pin does not become a lower voltage than the GND pin, including transient phenomena.
- 5) Thermal design
Perform thermal design in which there are adequate margins by taking into account the allowable power dissipation in actual states of use.
- 6) Shorts between pins and misinstallation
When mounting the LSI on a board, pay adequate attention to orientation and placement discrepancies of the LSI. If it is misinstalled and the power is turned on, the LSI may be damaged. It also may be damaged if it is shorted by a foreign substance coming between pins of the LSI or between a pin and a power supply or a pin and a GND.
- 7) Operation in strong magnetic fields
Adequately evaluate use in a strong magnetic field, since there is a possibility of malfunction.
- 8) A bias input coupling capacitor on the order of 10 μF ~33 μF is appropriate.
- 9) A clamp input coupling capacitor on the order of 0.1 μF ~1 μF is appropriate.
- 10) Make the clamp pulse width of the BA7606F/FS at least 1 μs .

●Ordering part number



SOP16

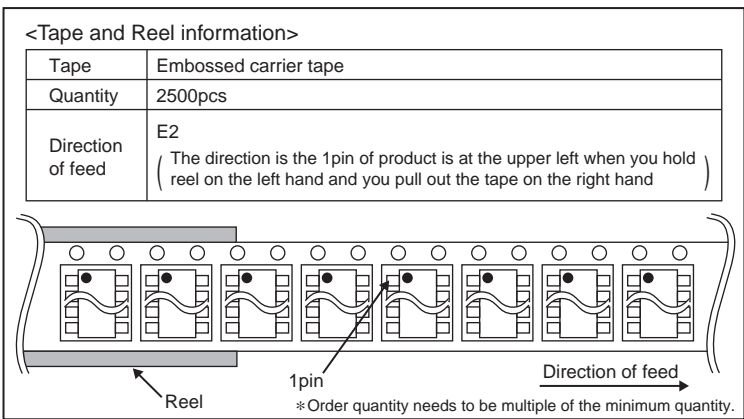
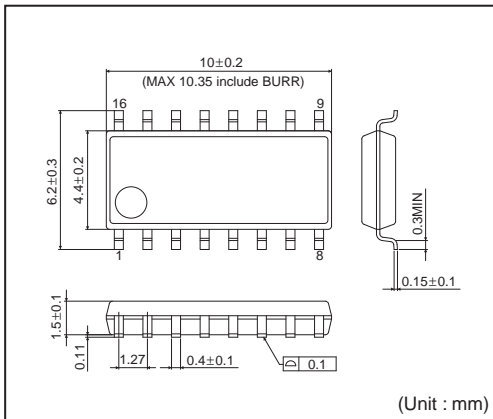

SSOP-A16

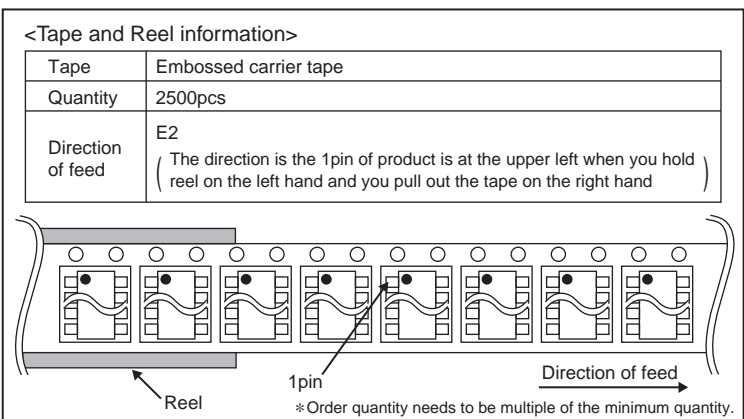
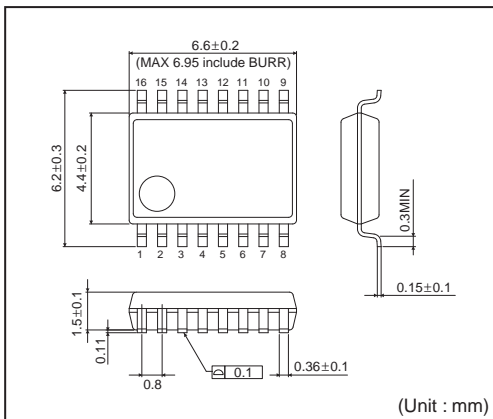

SSOP-B16

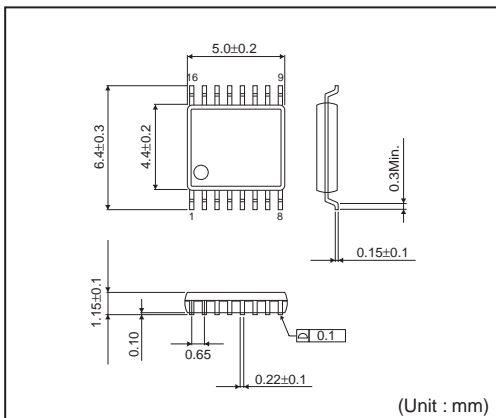

<Tape and Reel information>

Tape	Embossed carrier tape
Quantity	2500pcs
Direction of feed	E2 (The direction is the 1pin of product is at the upper left when you hold reel on the left hand and you pull out the tape on the right hand)

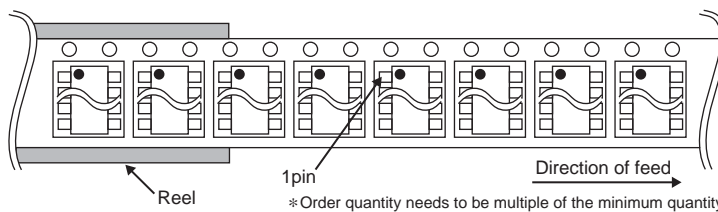

Notes

No copying or reproduction of this document, in part or in whole, is permitted without the consent of ROHM Co.,Ltd.

The content specified herein is subject to change for improvement without notice.

The content specified herein is for the purpose of introducing ROHM's products (hereinafter "Products"). If you wish to use any such Product, please be sure to refer to the specifications, which can be obtained from ROHM upon request.

Examples of application circuits, circuit constants and any other information contained herein illustrate the standard usage and operations of the Products. The peripheral conditions must be taken into account when designing circuits for mass production.

Great care was taken in ensuring the accuracy of the information specified in this document. However, should you incur any damage arising from any inaccuracy or misprint of such information, ROHM shall bear no responsibility for such damage.

The technical information specified herein is intended only to show the typical functions of and examples of application circuits for the Products. ROHM does not grant you, explicitly or implicitly, any license to use or exercise intellectual property or other rights held by ROHM and other parties. ROHM shall bear no responsibility whatsoever for any dispute arising from the use of such technical information.

The Products specified in this document are intended to be used with general-use electronic equipment or devices (such as audio visual equipment, office-automation equipment, communication devices, electronic appliances and amusement devices).

The Products specified in this document are not designed to be radiation tolerant.

While ROHM always makes efforts to enhance the quality and reliability of its Products, a Product may fail or malfunction for a variety of reasons.

Please be sure to implement in your equipment using the Products safety measures to guard against the possibility of physical injury, fire or any other damage caused in the event of the failure of any Product, such as derating, redundancy, fire control and fail-safe designs. ROHM shall bear no responsibility whatsoever for your use of any Product outside of the prescribed scope or not in accordance with the instruction manual.

The Products are not designed or manufactured to be used with any equipment, device or system which requires an extremely high level of reliability the failure or malfunction of which may result in a direct threat to human life or create a risk of human injury (such as a medical instrument, transportation equipment, aerospace machinery, nuclear-reactor controller, fuel-controller or other safety device). ROHM shall bear no responsibility in any way for use of any of the Products for the above special purposes. If a Product is intended to be used for any such special purpose, please contact a ROHM sales representative before purchasing.

If you intend to export or ship overseas any Product or technology specified herein that may be controlled under the Foreign Exchange and the Foreign Trade Law, you will be required to obtain a license or permit under the Law.





Thank you for your accessing to ROHM product informations.
More detail product informations and catalogs are available, please contact us.

ROHM Customer Support System

<http://www.rohm.com/contact/>

Looking for pricing, stock, or lifecycle information?

Click below to explore more details on WIN SOURCE:

-  [View BA7607F-E2 on WIN SOURCE](#)
-  [Rohm Semiconductor](#) Information

Optimize Your Supply Chain with WIN SOURCE Solutions

-  Global Sourcing Solution
-  Obsolete Management
-  Cost Control Management
-  Shortage Management
-  Alternative Solution
-  Excess Inventory Management