



**THE DATASHEET OF
R05P05S/X2**



Features

- Qualified with 65kV/ μ s @ Vcommon mode =1KV
- UL/CSA and IEC/EN safety certified
- High isolation 6.4kVDC/1s
- Optional continuous short circuit protection
- /X2 version with >9mm input/output clearance
- Suitable for IGBT applications

Unregulated Converters



RxxPxx

1 Watt
SIP7
Single and Dual
Output



Description

The RxxPxxS_D Series of DC/DC Converters are certified to UL/CSA60950-1 as well as EN60950-1. This makes them ideal for safety applications where approved isolation is required.

Selection Guide

Part Number	nom. Input Voltage [VDC]	Output Voltage [VDC]	Output Current [mA]	Efficiency typ. ⁽¹⁾ [%]	max. Capacitive Load ⁽²⁾ [μ F]
RxxP3.3S ^(3,4)	5, 9, 12, 15, 24	3.3	303	70	2200
RxxP05S ^(3,4)	5, 9, 12, 15, 24	5	200	70 - 75	1000
RxxP09S ^(3,4)	5, 9, 12, 15, 24	9	111	70 - 75	1000
RxxP12S ^(3,4)	5, 9, 12, 15, 24	12	84	70 - 75	470
RxxP15S ^(3,4)	5, 9, 12, 15, 24	15	66	75 - 80	470
RxxP3.3D ⁽⁴⁾	5, 9, 12, 15, 24	\pm 3.3	\pm 151	70	\pm 1000
RxxP05D ⁽⁴⁾	5, 9, 12, 15, 24	\pm 5	\pm 100	70 - 75	\pm 470
RxxP09D ⁽⁴⁾	5, 9, 12, 15, 24	\pm 9	\pm 55	70 - 75	\pm 470
RxxP12D ⁽⁴⁾	5, 9, 12, 15, 24	\pm 12	\pm 41	70 - 75	\pm 220
RxxP15D ⁽⁴⁾	5, 9, 12, 15, 24	\pm 15	\pm 33	75 - 80	\pm 220
RxxP1509D ⁽⁴⁾	12, 24	+15/-9	+33/-56	70 - 80	\pm 220
R05P1509D ⁽⁴⁾	5	+15/-9	\pm 42	70 - 80	+68/-220

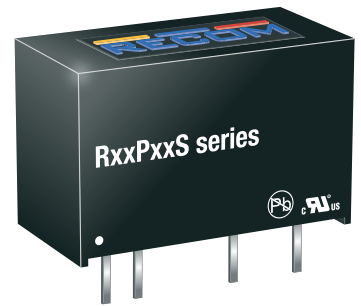

Notes:

- Note1: Efficiency is tested at nominal input and full load at +25°C ambient
 Note2: Max. Capacitive Load is defined as the capacitive load that will allow start up in under 1 second without damage to the converter

Model Numbering

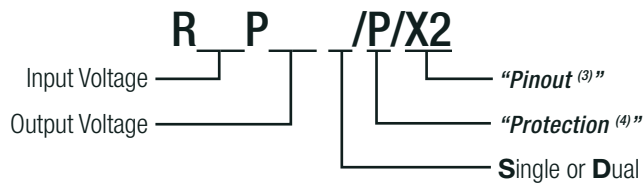

Notes:

- Note3: add suffix „/X2“ for single output with alternative pinout
 Note4: add suffix „P“ for continuous short circuit protection

Ordering Examples:

- R05P05S/P = 5V Input, 5V Output, Single Output, Continuous Short Circuit Protection
 R05P3.3D/P = 5V Input, 3.3V Output, Dual Output, Continuous Short Circuit Protection
 R05P05S/P/X2 = 5V Input, 5V Output, Single Output, Continuous Short Circuit Protection, Alternative Pinout

IEC/EN62368-1 certified
 UL/CSA60950-1 certified
 UL/CSA62368-1 certified
 EN55032 compliant
 CB Report



www.recom-power.com/eval-ref-boards

www.recom-power.com/bjier

Specifications (measured @ Ta= 25°C, nom. Vin, full load and after warm-up unless otherwise stated)

BASIC CHARACTERISTICS

Parameter	Condition	Min.	Typ.	Max.
Input Voltage Range			±10%	
Minimum Load		0%		
Internal Operating Frequency	all types PxxP1509D	20kHz 20kHz	50kHz 60kHz	85kHz
Output Ripple and Noise	20MHz BW			200mVp-p

Efficiency vs. Load

RxxP05S and RxxP09S

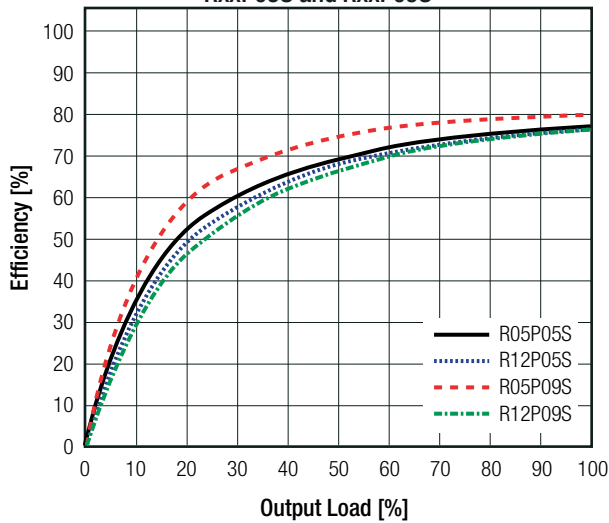

RxxP05D and RxxP09D

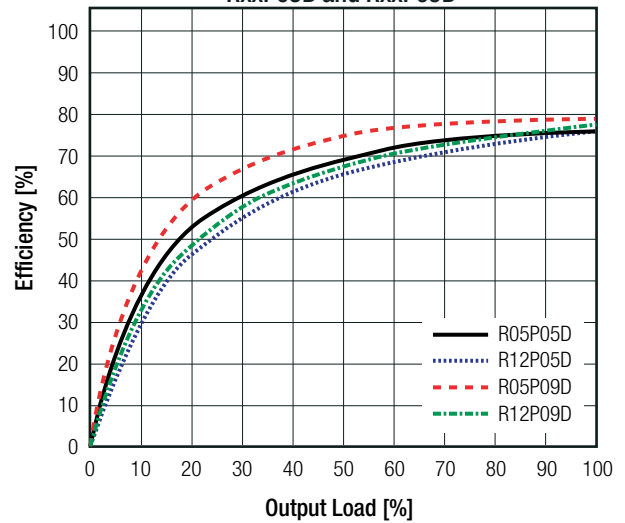

RxxP12S and RxxP15S

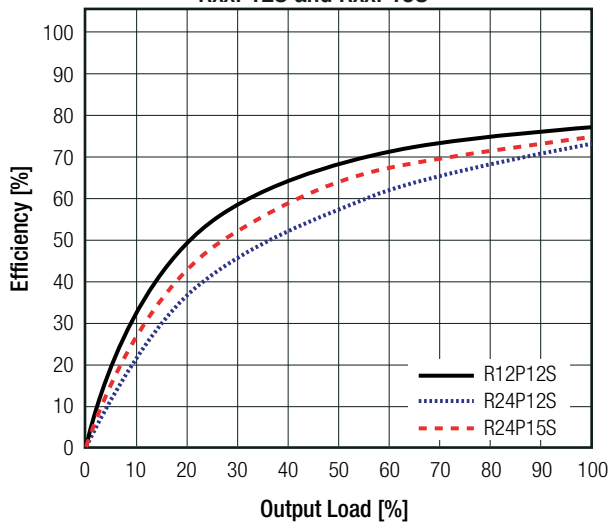

RxxP12D and RxxP15D

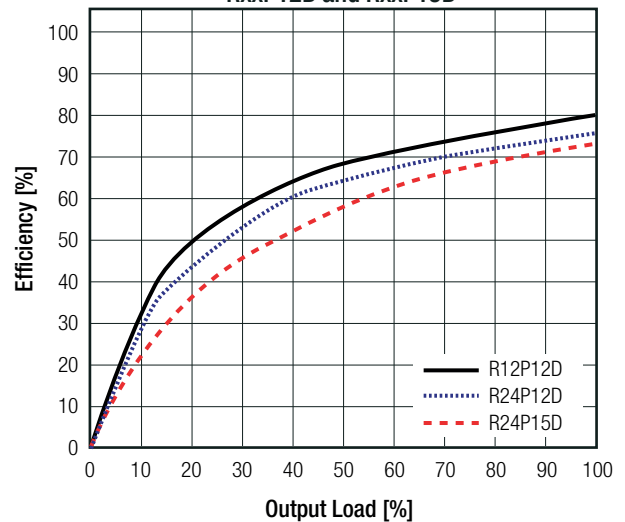

REGULATIONS

Parameter	Condition		Value
Output Accuracy			±5.0% max.
Line Regulation	low line to high line, full load		±1.2% of 1.0% Vin typ.
Load Regulation ⁽⁵⁾	10% to 100% load	3.3, 5VDC 9, 12, 15VDC	15% typ. 10% typ.

Notes:

Note5: Operation below 10% load will not harm the converter, but specifications may not be met

continued on next page

Specifications (measured @ Ta= 25°C, nom. Vin, full load and after warm-up unless otherwise stated)

Tolerance Envelope

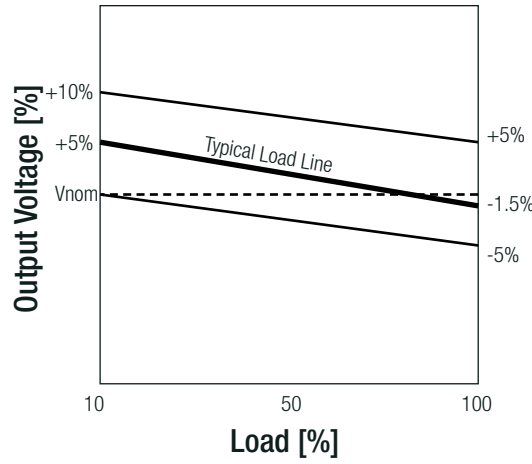

Deviation vs. Load

RxxP05S and RxxP09S

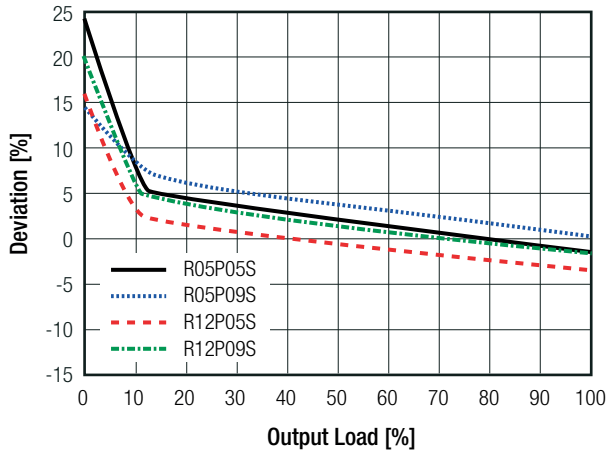

RxxP05D and RxxP09D

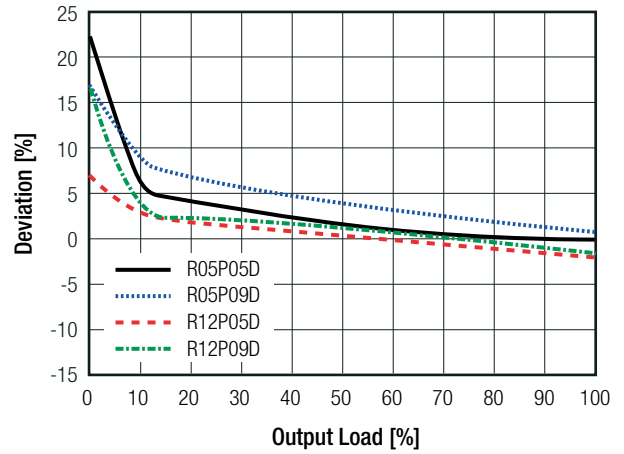

RxxP12S and RxxP15S

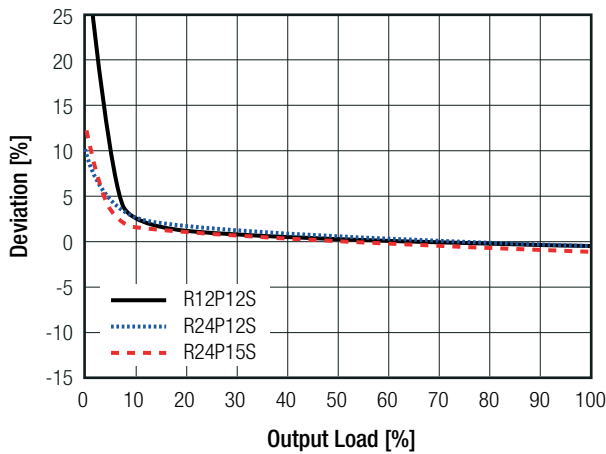

RxxP12D and RxxP15D

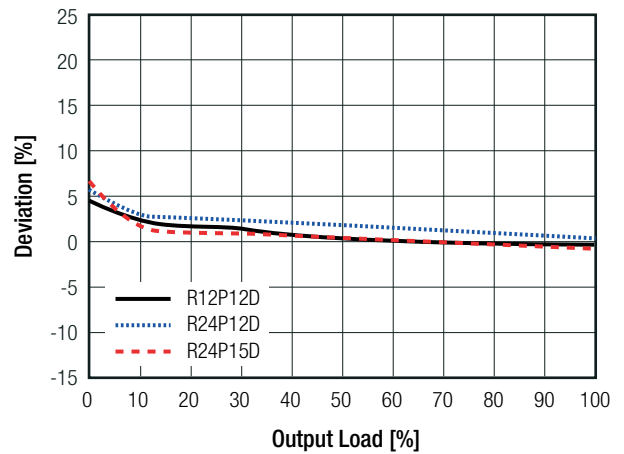

Specifications (measured @ Ta= 25°C, nom. Vin, full load and after warm-up unless otherwise stated)

PROTECTIONS			
Parameter	Type	Value	
Short Circuit Protection (SCP)	without suffix with suffix "/P"	1 second continuous	
Isolation Voltage ⁽⁶⁾	I/P to O/P	tested for 1 second	6.4kVDC
		rated for 1 minute	3.2kVAC/60Hz
		working voltage	250VACrms
Isolation Resistance		15GΩ min.	
Isolation Capacitance		4.0pF min. / 10pF max.	
Insulation Grade	according to 62368-1	basic	
Notes: Note6: For repeat Hi-Pot testing, reduce the time and/or the test voltage Note7: Refer to local safety regulations if input over-current protection is required. Recommended fuse: slow blow type			

ENVIRONMENTAL			
Parameter	Condition	Value	
Operating Temperature Range	without derating @ free air convection	-40°C to +90°C	
Operating Altitude	according to 62368-1	2000m	
	according to 60601-1	3000m	
Operating Humidity	non-condensing	95% RH max.	
Pollution Degree		PD2	
MTBF	according to MIL-HDBK-217F, G.B.	+25°C	2974 x 10 ³ hours
		+85°C	728 x 10 ³ hours

Derating Graph

(@ Chamber and free air convection)

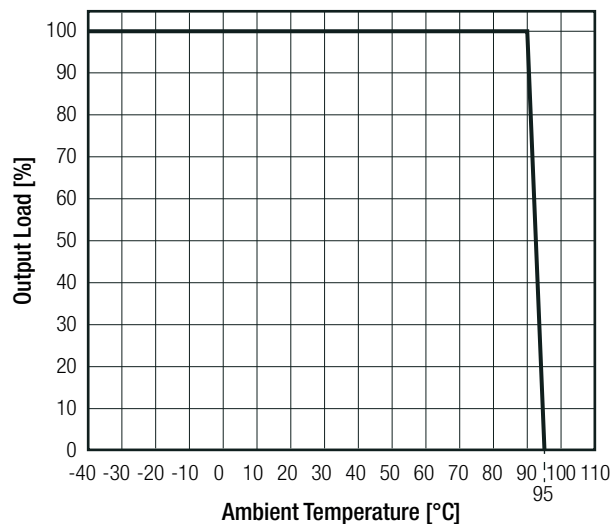

Specifications (measured @ Ta= 25°C, nom. Vin, full load and after warm-up unless otherwise stated)

SAFETY AND CERTIFICATIONS

Certificate Type (Safety)	Report / File Number	Standard
Information Technology Equipment, General Requirements for Safety	E224736-A56-UL	UL60950-1, 2nd Edition, 2014 CAN/CSA C22.2 No. 60950-1, 2nd Edition, 2014
Information Technology Equipment, General Requirements for Safety	LVD1602031	EN60950-1:2006 + A2:2013 IEC60950-1:2005 2nd Edition + A2:2013
Audio/Video, information and communication technology equipment. Safety requirements	E224736-A56-UL	UL62368-1, 2nd Edition, 2014 CAN/CSA C22.2 No. 62368-1, 2nd Edition, 2014
Audio/Video, information and communication technology equipment - Part1: Safety requirements	ATTCB106076	EN62368-1: 2014 + A11:2017
Audio/Video, information and communication technology equipment - Part1: Safety requirements (CB Scheme)		IEC62368-1:2014, 2nd Edition
Medical electrical equipment Part 1: General requirements for basic safety and essential performance	WD-SE-R-180541-A0	EN60601-1:2006 + A12:2014 IEC60601-1:2005 + A1:2012, 3rd Edition
EAC	RU-AT.49.09571	TP TC 004/2011
RoHS2		RoHS-2011/65/EU + AM2015/863

EMC Compliance	Condition	Standard / Criterion
Electromagnetic compatibility of multimedia equipment - Emission requirements	with external filter (see filter suggestion below)	EN55032, Class A and B

EMC Filter Suggestion according to EN55032

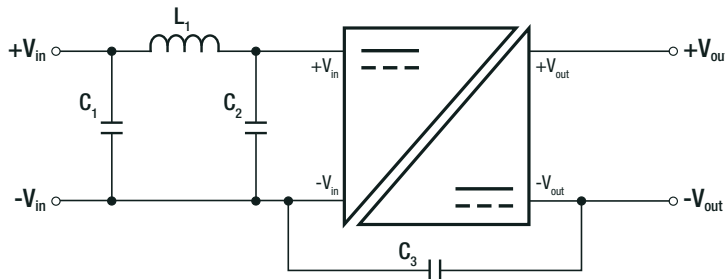

Component List Class A

MODEL	C1	L1	C2	C3 (safety)
R05P05S	22µF	N/A	N/A	N/A
R05P12S	MLCC		N/A	
R12P05S	10µF		4.7µF	
R24P05S	MLCC		MLCC	

Component List Class B

MODEL	C1	L1	C2	C3 (safety)
R05P05S	10µF MLCC	22µH choke RLS-226	N/A	1nF
R05P12S				
R12P05S				
R24P05S				

Notes:

Note8: Filter suggestions are valid for indicated part numbers only. For other part numbers, please contact RECOM tech support for advice

DIMENSION AND PHYSICAL CHARACTERISTICS

Parameter	Type	Value
Material	case potting PCB	non-conductive black plastic, (UL94 V-0) epoxy, (UL94 V-0) FR4, (UL94 V-0)
Dimension (LxWxH)		19.5 x 9.8 x 12.5mm
Weight		4.3g typ.

continued on next page

Specifications (measured @ Ta= 25°C, nom. Vin, full load and after warm-up unless otherwise stated)

Dimension Drawing (mm)

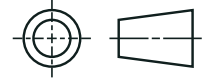
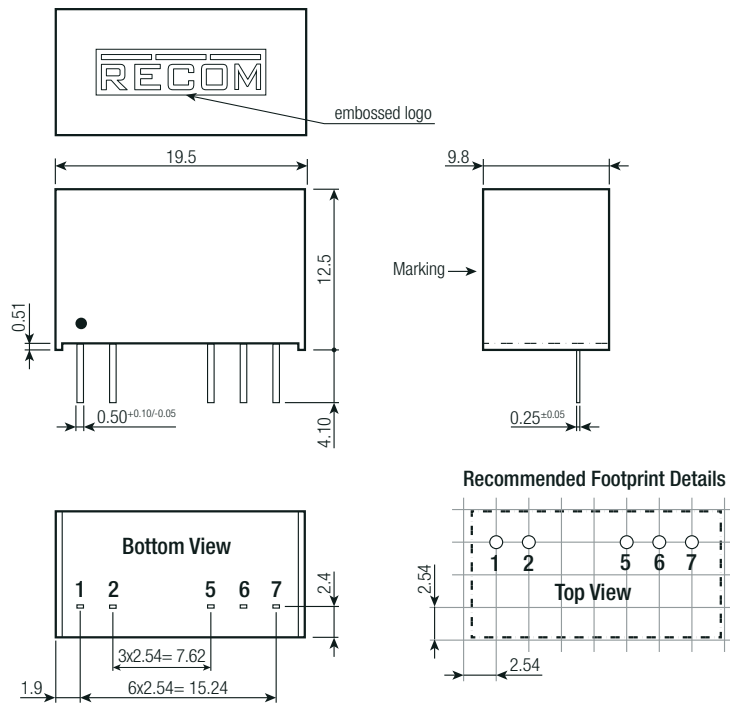

Pin Connection

Pin #	Single	Dual	/X2
1	+Vin	+Vin	+Vin
2	-Vin	-Vin	-Vin
5	-Vout	-Vout	No Pin
6	No Pin	Com	-Vout
7	+Vout	+Vout	+Vout

Tolerance: xx.x= ±0.5mm
xx.xx= ±0.25mm

INSTALLATION AND APPLICATION

IGBT Application Circuit

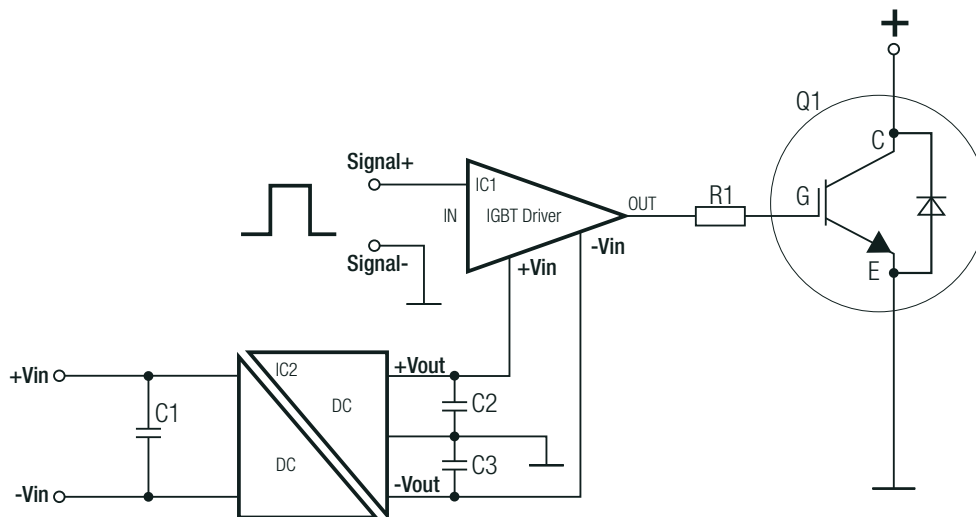



PACKAGING INFORMATION

Parameter	Type	Value
Packaging Dimension (LxWxH)	tube	520.0 x 22.3 x 12.0mm
Packaging Quantity	tube	25pcs
Storage Temperature Range		-55°C to +125°C
Storage Humidity		95% RH max.

The product information and specifications may be subject to changes even without prior written notice. The product has been designed for various applications; its suitability lies in the responsibility of each customer. The products are not authorized for use in safety-critical applications without RECOM's explicit written consent. A safety-critical application is an application where a failure may reasonably be expected to endanger or cause loss of life, inflict bodily harm or damage property. The applicant shall indemnify and hold harmless RECOM, its affiliated companies and its representatives against any damage claims in connection with the unauthorized use of RECOM products in such safety-critical applications.

Looking for pricing, stock, or lifecycle information?

Click below to explore more details on WIN SOURCE:

-  [View R05P05S/X2 on WIN SOURCE](#)
-  [Recom Power Information](#)

Optimize Your Supply Chain with WIN SOURCE Solutions

-  Global Sourcing Solution
-  Obsolete Management
-  Cost Control Management
-  Shortage Management
-  Alternative Solution
-  Excess Inventory Management